

VHF/UHF functions and features

Superb readability in the VHF/UHF band

The IC-9100 provides excellent receiver sensitivity in the VHF/UHF bands, equivalent to the highly-acclaimed previous VHF/UHF dedicated model, the IC-910H. The IF DSP greatly improves intermodulation and noise elimination and offers better readability than the IC-910H.

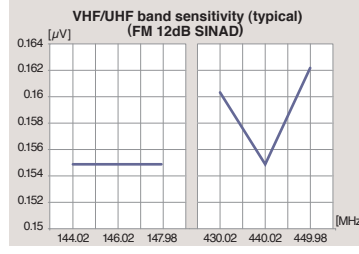

Ready-to-install 1200MHz band unit

By installing the optional UX-9100 1200MHz band unit, you can be operational on the 1200MHz band immediately. The IC-9100 fully covers the HF/50, 144, 430/440 and 1200MHz amateur bands in multiple modes.



UX-9100, 1200MHz band unit

Satellite mode operation

The satellite mode synchronizes the uplink (transmitting) and downlink (receiving) frequencies, and tracks the frequencies in the same tuning step. This function matches both normal and reverse mode satellites. Compensation of the Doppler effect can be performed easily. 20 satellite memory channels store frequencies, mode and tone settings for quick set-up.

Optional D-STAR® DV mode (* Digital Smart Technology for Amateur Radio)

The optional UT-121 provides D-STAR DV mode digital voice and low speed data communication. Linking of D-STAR repeaters over the Internet allows you to communicate virtually anywhere. In addition to 144MHz, 430/440MHz and 1200MHz band, the D-STAR DV mode can be used in 28MHz and 50MHz band simplex mode.

- D-STAR DR mode operation makes it easy to access D-STAR repeaters
- GPS position reporting functions (External GPS receiver can be connected via data 1 connector. Position data can be entered manually.)
- One-touch reply function
- Digital call sign squelch
- Received call sign record
- Automatic received message display



UT-121, D-STAR UNIT



Received GPS data indication example

Other VHF/UHF features

- VSC (Voice Squelch Control) function
- AFC function (FM/DV mode)
- CTCSS and DTCS tone encoder and decoder
- 9600bps data socket
- Automatic repeater function* and one-touch repeater function (* USA and KOR versions only)

HF/VHF/UHF TRANSCEIVER

SPECIFICATIONS

GENERAL

Receive		Transmit	
Frequency coverage (unit: MHz) **			
0.030~ 60.000**	136.000~ 174.000**		
420.000~ 480.000**	1240.000~ 1320.000**		
1.800~ 1.999	3.500~ 3.999		
5.255~ 5.405**	7.000~ 7.300		
10.100~ 10.150	14.000~ 14.350		
18.068~ 18.168	21.000~ 21.450		
24.890~ 24.990	28.000~ 29.700		
50.000~ 54.000	144.000~ 148.000		
430.000~ 450.000	1240.000~ 1300.000**		

** Showing USA version, frequency coverage depends on version.

** Some frequency ranges are not guaranteed. ** With optional UX-9100.

- Mode : USB, LSB, CW, RTTY (FSK), FM, AM*, DV (with UT-121)
- * Transmit HF/50MHz only. Cannot receive on 1200MHz band.
- No. of memory channels : 395 Ch (99 Ch for each HF/50, 144, 430/440, 1200MHz band)
- 4 Call Ch* (1 Ch for each band)
- 24 Scan edges* (6 Ch for each band)
- 20 satellite and 50 GPS memories
- *With optional UX-9100.

- Power supply requirement : 13.8V DC ±15%
- Operating temp. range : 0°C to +50°C; +32°F to +122°F
- Frequency stability : Less than ±0.5ppm (0°C to +50°C)
- Current drain (at 13.8V DC) : IC-9100 UX-9100
- TX Max. power : 24.0A 11.0A
- RX Max. audio : 4.5A 5.5A

- Antenna connector : HF/50MHz SO-239 (50Ω) *2
- 144MHz SO-239 (50Ω)
- 430/440MHz Type-N (50Ω)
- 1200MHz Type-N (50Ω) (With UX-9100)
- Dimensions (W×H×D) : 315×116×343 mm;
- (Projections not included) : 12.4×4.57×13.5 in
- Weight (approx.) : IC-9100 11kg; 24.3lb
- UX-9100 950g; 2.1lb

TRANSMITTER

- Modulation system : Digital PSN modulation
- SSB : Digital Low power modulation
- AM : Digital Phase modulation
- FM : GMSK Digital Phase modulation
- DV (With UT-121)

Output power	HF/50MHz	144MHz	440MHz	1200MHz**
SSB/CW/RTTY/FM/DV*2	2-100W	2-100W	2-75W	1-10W
AM	2-30W	---	---	---

** With UX-9100 **2 With UT-121

- Spurious emissions (Spurious domain) : 1.8~29.7MHz Less than -50dB
- 50, 144MHz Less than -63dB
- 430/440MHz Less than -61.8dB
- 1200MHz Less than -53dB (With UX-9100)

- Carrier suppression : More than 40dB
- Unwanted sideband : More than 55dB
- 1200MHz : More than 40dB (With UX-9100)
- Microphone connector : 8-pin connector (600Ω)

RECEIVER

- Intermediate frequencies : HF/50MHz 64.455MHz, 36kHz
- 144MHz 10.850MHz, 36kHz
- 430/440MHz 71.250MHz, 36kHz
- 1200MHz(With UX-9100) 243.950MHz, 10.950MHz, 36kHz

Sensitivity	
0.5-1.8MHz	1.8-29.7MHz
SSB/CW	50-54MHz
AM	144/440MHz
FM	1200MHz*1
DV**2	

- SSB/CW, AM : 10dB SIN, FM : 12dB SINAD, DV : 1% BER
- ** With UX-9100 **1 With UT-121 **2 Preamp-1 ON ** Preamp-2 ON ** 28-29.7MHz

OPTIONS

Some options may not be available in some countries. Please ask your dealer for details.

Icom, Icom Inc. and the Icom logo are registered trademarks of Icom Incorporated (Japan) in the United States, the United Kingdom, Germany, France, Spain, Russia, Japan and/or other countries.

Icom Inc. 1-1-32, Kami-minami, Hirano-ku, Osaka 547-0003, Japan Phone: +81 (06) 6793 5302 Fax: +81 (06) 6793 0013 www.icom.co.jp/world **Count on us!**

Icom America Inc.
2380 116th Avenue NE,
Bellevue, WA 98004, U.S.A.
Phone: +1 (425) 454-8155
Fax: +1 (425) 454-1509
E-mail: sales@icomamerica.com
URL : <http://www.icomamerica.com>

Icom Canada
Glenwood Centre #150-6165 Highway 17,
Delta, B.C., V4K 5B8, Canada
Phone: +1 (604) 952-4266
Fax: +1 (604) 952-0090
E-mail: info@icomcanada.com
URL : <http://www.icomcanada.com>

Icom (Australia) Pty. Ltd.
Unit 1 / 103 Garden Road,
Clayton, VIC 3168 Australia
Phone: +61 (03) 9549 7500
Fax: +61 (03) 9549 7505
E-mail: sales@icom.net.au
URL : <http://www.icom.net.au>

Icom New Zealand
146A Harris Road, East Tamaki,
Auckland, New Zealand
Phone: +64 (09) 274 4062
Fax: +64 (09) 274 4708
E-mail: inquiries@icom.co.nz
URL : <http://www.icom.co.nz>

Icom (Europe) GmbH
Communication Equipment
Auf der Krautweide 24
65812 Bad Soden am Taunus, Germany
Phone: +49 (6196) 76885-0
Fax: +49 (6196) 76885-50
E-mail: info@icom-europe.com
URL : <http://www.icomeurope.com>

Icom Spain S.L.
Cra Rubi, No. 88 "Edificio Can Castanyer"
Bajos A 08174, Sant Cugat del Valles,
Barcelona, Spain
Phone: +34 (93) 590 26 70
Fax: +34 (93) 589 04 48
E-mail: icom@icomspain.com
URL : <http://www.icomspain.com>

Icom (UK) Ltd.
Blacksloe House, Altra Park,
Herne Bay, Kent, CT16 6GZ, U.K.
Phone: +44 (0)1227 741741
Fax: +44 (0)1227 741742
E-mail: info@icomuk.co.uk
URL : <http://www.icomuk.co.uk>

Icom France s.a.s.
Zac de la Plaine,
1 Rue Brindejonc des Moulinais, BP 45804,
31505 Toulouse Cedex 5, France
Phone: +33 (5) 61 36 03 03
Fax: +33 (5) 61 36 03 00
E-mail: icom@icom-france.com
URL : <http://www.icom-france.com>

Icom Poland
81-850 Sopot, ul. S. Majaj 54, Poland
Phone: +48 (58) 550 7135
Fax: +48 (58) 550 7135
E-mail: icompolaska@icompolaska.pl
URL : <http://www.icompolaska.pl>

IC-9100



HF/VHF/UHF TRANSCEIVER

IC-9100

HF VHF UHF D-STAR GPS SATELLITE EME

The All-round Transceiver, IC-9100



Double conversion & IF DSP technologies that support the IC-9100

Double conversion superheterodyne

Icom's basic idea about the best receiver circuit is to reproduce high fidelity audio without internal distortion. Our answer to achieve this goal is to adopt a double conversion superheterodyne system*. The double conversion system simplifies the electronic circuitry and reduces the number of components which cause internal distortion. The digital signal processing (DSP) technologies and image rejection mixer make it possible to adopt this system.
* A triple conversion system is used for the 1200MHz band.

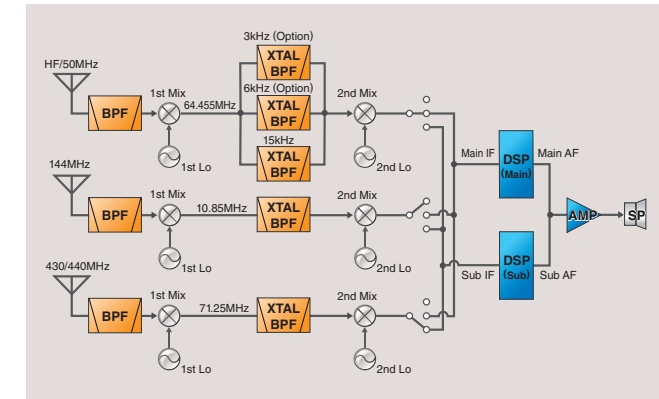

Independent dual receivers

As seen in the above figure, the IC-9100 has 3 independent receiver circuits from the antenna connector to the second IF mixer (image rejection mixer). One each for HF/50MHz, 144MHz, 430/440MHz bands. See the table below for simultaneous receive pairs.

Main band	Sub band	HF/50MHz band	144MHz band	430/440MHz band	1200MHz band
HF/50MHz		-	✓	✓	✓*1
144MHz		✓	-	✓	✓*1
430/440MHz		✓	✓	-	✓*1
1200MHz		✓*1	✓*1	✓*1	-

*1 With optional UX-9100.

32-bit floating point DSP & 24-bit AD/DA converters

The heart of the IC-9100 is the proven combination of the 32-bit floating point DSP and 24-bit AD/DA converters. This powerful combination supports many digital processing features.



AGC loop management

Digital IF filters, manual notch filter and other digital functions are incorporated in the AGC loop management controlled by the DSP unit. The AGC effectively works for the desired signal and rejects blocking by strong adjacent signals out of the filter passband. The AGC time constant presets (slow, medium and fast) give the flexibility and speed needed for working pile-ups.

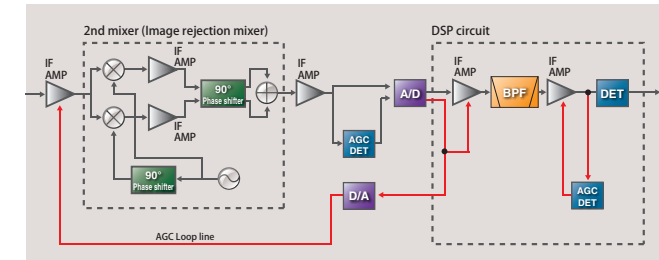

Digital IF filter

The IC-9100 DSP allows you to "build your own" digital IF filter. You can quickly choose bandwidth, shape factor, and center frequency, so that you can work that rare DX station. Three filter memories allow you to change filter settings instantly, a great help during contesting or other tough conditions.

Mode	Passband width range
SSB, SSB-D, CW	50Hz-500Hz (50Hz step), 600Hz-3600Hz (100Hz step)
RTTY	50Hz-500Hz (50Hz step), 600Hz-2700Hz (100Hz step)
AM, AM-D	200Hz-10.0kHz (200Hz step)
FM, FM-D, DV* (* option)	15kHz, 10kHz, 7.0kHz (Fixed)

Digital twin PBT and IF shift

After "building your own" digital IF filter, you can use the digital twin Passband Tuning (PBT) to shift and narrow the IF passband until the interference is gone and you can clearly hear that weak signal.

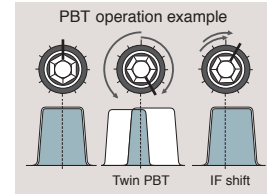

Noise reduction

The 16-step variable noise reduction can significantly enhance the receiver's signal-to-noise ratio, giving you a clean, clear audio signal that may make the difference between making the contact or not.

Noise blanker

The digital noise blanker reduces interference from pulse-type noise such as engine ignition. The noise blanker allows you to change the threshold level as well as blank duration parameter and attenuation level.

RF speech compressor

The digital RF speech compressor boosts average talk power, improving signal strength and readability in SSB mode. It is useful for breaking through the noise and complete the QSO.

Adjustable transmit bandwidth

The transmit bandwidth is selectable from 100, 200, 300, 500Hz at the low-pass edge, and 2500, 2700, 2800, 2900Hz at the high-pass edge, respectively. Three types of high and low combinations can be stored in the memory as favorite settings.

HF/50MHz, 144MHz 100W, 430/440MHz 75W

The IC-9100 uses high efficiency power amplifiers and large heat sink providing stable output power, even during long periods of operation.

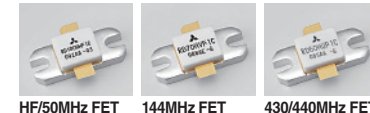

HF/VHF/UHF TRANSCIVER IC-9100

HF/50MHz functions and features

+30dBm class third-order intercept point

Using receiver design techniques introduced in Icom's highest grade HF transceivers, the IC-9100 has an IP3 of +30dBm (typ.) in 14MHz band. Even a weak signal adjacent to strong signals is clearly received by the IC-9100.

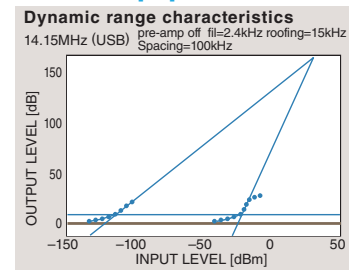

Three first IF filters (3/6/15kHz) for HF/50MHz band

The IC-9100 comes with a built-in 15kHz 1st IF filter and can accept up to two optional filters (3kHz FL-431 and 6kHz FL-430). By changing the first IF filter width according to the operating mode, the desired signal is protected from adjacent inband signals at the later stages for better receiver performance.

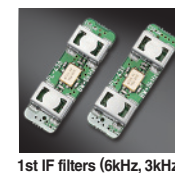

RTTY demodulator and decoder

The built-in RTTY demodulator and decoder allow you to instantly read an RTTY message on the display. No external units or PC required. The built-in tuning indicator visually helps in critical tuning.

Ample CW functions

All of the following CW capabilities are included in the IC-9100:
 • 4 channels of keyer with 70 characters of memory per channel
 • Multi-function electronic keyer with adjustable keying speed from 6-48 wpm, dot-dash ratio from 1:1.2:8 to 1:1.4:5 and paddle polarity
 • Bug keyer and full break-in function

Built-in Antenna Tuner for HF/50MHz band

The internal antenna tuner automatically tunes for low SWR in the HF and 50MHz bands. Once you transmit on a frequency, the tuner can instantly retune the frequency using its built-in memory.

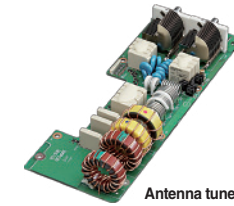

Manual notch filter and auto notch filter

The manual notch filter controlled by the DSP has extremely sharp characteristics and provides more than 70dB of attenuation. It eliminates persistent beat tones without affecting the AGC loop function. The automatic notch filter tracks and eliminates two or more interfering signals, such as beat signals and carriers or tones from digital signals.

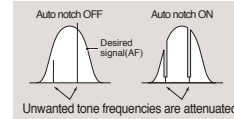

Other HF/50MHz features

- Two preamplifier types for HF/50MHz bands: Preamp 1: Increases low level signal improving intermodulation, Preamp 2: High gain preamplifier
- Triple band stacking register
- Quick split and frequency lock functions
- RIT and ΔTx variable up to ± 9.999kHz
- SSB/CW synchronous tuning automatically shifts the carrier point when switching between CW and LSB/USB modes
- AH-4 control circuit

HF to UHF common features

- Built-in voice synthesizer announces operating frequency, mode and S-meter level
- User programmable band edge beep (Can be disabled)
- Microphone equalizer and adjustable transmit bandwidth
- 20dB built-in attenuator
- ±0.5ppm high frequency stability
- Audio equalizer function
- 1Hz pitch tuning and display
- Automatic tuning steps
- Program, memory, select memory, mode select and Δf scanning
- Up to 224 memory channels* (* With optional UX-9100)
- Headphone separate function (left for main audio, right for sub audio)



Sophisticated operation with expansion capabilities

Large, Multi-function LCD

The large multi-function LCD displays frequency, 9-character channel name, channel number, multi functional meter (includes S-meter, RF output, SWR and ALC level) for both the main and sub bands vertically. The dot-matrix portion of the LCD shows the following items:

- Channel name
- Function key assignment
- Band scope
- RTTY decoder screen
- Memory keyer contents
- Graphical SWR scale
- D-STAR call sign, message, DR list
- GPS position information.

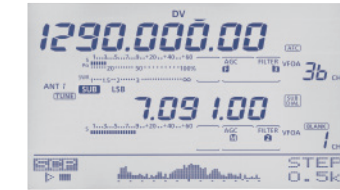

USB connector for PC control

The IC-9100 has a standard type B USB connector and can be connected to a PC. Modulation input, audio output, RTTY demodulator output and CI-V command can be controlled via the USB cable. Also, the conventional CI-V remote control jack is built in to the IC-9100.

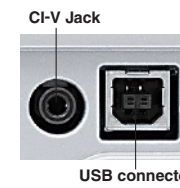

Optional CS-9100 programming software

When used with the optional CS-9100 programming software, memory channels, band edges, repeater list for DR mode, D-STAR call sign and GPS memory channels can be easily edited with a PC. A USB cable is required for PC connection.

Optional RS-BA1 IP remote control software

The optional RS-BA1 allows you to use the IC-9100 from another room using your home network, or even from a remote location over the Internet. The RS-BA1 has low voice latency.

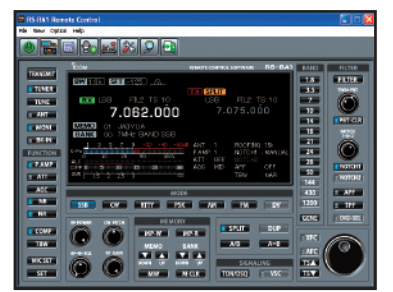

IP Remote Control through your Home Network

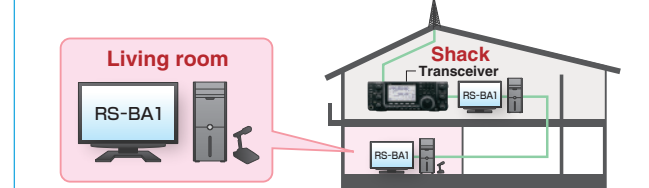

IP Remote Control over the Internet

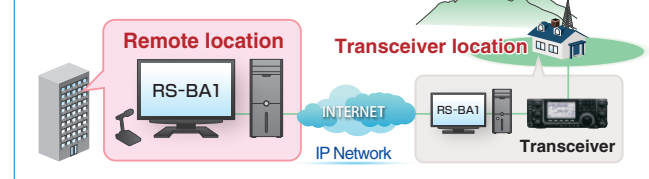

REAR PANEL VIEW

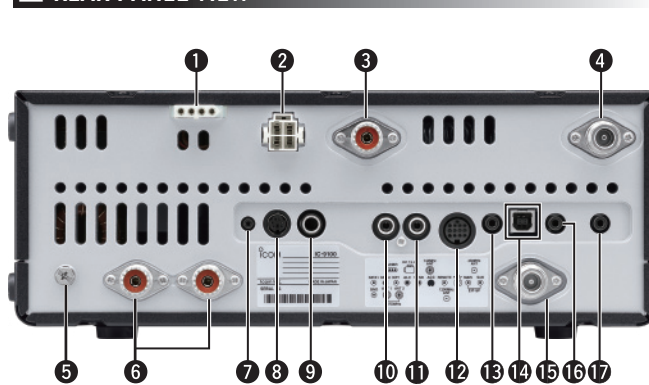

- | | |
|--------------------------------|---|
| ① Tuner Socket | ⑩ ALC Input Jack |
| ② DC Power Socket | ⑪ Send Control Jack |
| ③ 144MHz Antenna Connector | ⑫ ACC Socket |
| ④ 430/440MHz Antenna Connector | ⑬ CI-V Remote Control Jack |
| ⑤ Ground Terminal | ⑭ USB Connector |
| ⑥ HF/50MHz Antenna Connectors | ⑮ 1200MHz Antenna Connector (With optional UX-9100) |
| ⑦ Data1 Jack | ⑯ External Speaker Jack (Main) |
| ⑧ Data2 Jack | ⑰ External Speaker Jack (Sub-band) |
| ⑨ Key Jack | |

- Dimensions (W×H×D) : 315×116×343 mm; (Projections not included) : 12.4×4.57×13.5 in
- Weight (approx.) IC-9100 : 11kg; 24.3lb
UX-9100 : 950g; 2.1lb