

### RoIP GATEWAY

# VE-PG4

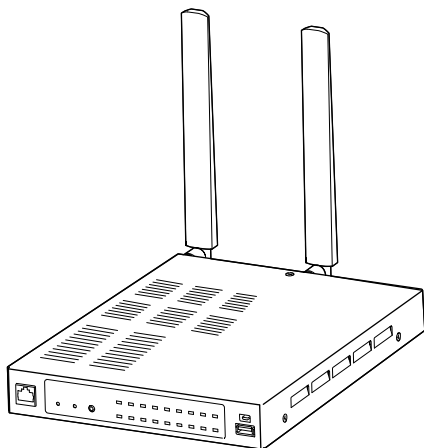

Icom Inc.

### INTRODUCTION

1 TOP

2 INFORMAITON

3 NETWORK SETTINGS

4 ROUTER SETTINGS

5 BRIDGE CONNECTION SETTINGS

6 TRANSCEIVER CONTROLLER

7 CONNECTION PORT SETTINGS

8 DESTINATION SETTINGS

9 EXPERT SETTINGS

10 IP LINE SETTINGS

11 PBX

12 PBX TRANSCEIVER CALL SETTINGS

13 PBX EXTENSION

14 PBX ADVANCED SETTINGS

15 MANAGEMENT

---

## INTRODUCTION

Thank you for choosing this Icom product. The VE-PG4 RoIP GATEWAY is designed and built with Icom's IP network technology.

With proper care, this product should provide you with years of trouble-free operation.

① This document is described based on the VE-PG4 firmware version 1.11.

Icom is not responsible for the destruction, damage to, or performance of any Icom or non-Icom equipment, if the malfunction is because of:

- Force majeure, including, but not limited to, fires, earthquakes, storms, floods, lightning, other natural disasters, disturbances, riots, war, or radioactive contamination.
- The use of Icom transceivers with any equipment that is not manufactured or approved by Icom.

ALL RIGHTS RESERVED. This document contains material protected under International and Domestic Copyright Laws and Treaties. Any unauthorized reprint or use of this material is prohibited. No part of this document may be reproduced or transmitted in any form or by any means, electronic or mechanical, including photocopying, recording, or by any information storage and retrieval system without express written permission from Icom Incorporated.

All stated specifications and design are subject to change without notice or obligation.

Icom, Icom Inc. and the Icom logo are registered trademarks of Icom Incorporated (Japan) in Japan, the United States, the United Kingdom, Germany, France, Spain, Russia, Australia, New Zealand, and/or other countries.

AMBE+2 is a trademark of Digital Voice Systems, Inc.

Microsoft and Windows are registered trademarks of Microsoft Corporation in the United States and/or other countries.

All other products or brands are registered trademarks or trademarks of their respective holders.

## ■ Voice coding technology

The AMBE+2™ voice coding Technology embodied in this product is protected by intellectual property rights including patent rights, copyrights and trade secrets of Digital Voice Systems, Inc. This voice coding Technology is licensed solely for use within this Communications Equipment.

The user of this Technology is explicitly prohibited from attempting to extract, remove, decompile, reverse engineer, or disassemble the Object Code, or in any other way convert the Object Code into a human-readable form. U.S. Patent Nos.

#8,595,002, #8,359,197, #8,315,860, #8,200,497, #7,970,606, and #6,912,495 B2.

---

## ABOUT THE CONSTRUCTION OF THE MANUAL

---

You can use the following manuals to understand and operate this RoIP Gateway.

**Precautions (Comes with the RoIP Gateway)**

Instructions for the connections, initialization, and precautions.

**Installation guide (PDF type)**

Instructions for the system requirements, the system setup basics, maintenance, and the specifications. It can be downloaded from the Icom website.

**Operating guide (This manual, PDF type)**

The detailed references for the settings in the RoIP Gateway setting screen. It can be downloaded from the Icom website.

Also refer to the manual for each device, that is connected to your system.

---

TOP screen .....	1-2
■ System Status .....	1-2
■ MAC Address .....	1-2
■ WAN Status .....	1-3
■ LTE Status .....	1-3



## TOP screen

TOP

### ■ System Status

Displays the firmware version, Date and Time, uptime, and memory usage.

System Status	
Host Name	VE-PG4
Version	
IP100H Firmware Version	
Current Time	8:35:04
Uptime	0 day 00:05:40
Memory Usage	434416 kB / 993568 kB (43% used)

① See “Transceiver Management” screen in this manual for details on the firmware version of each IP100H that is registered to the RoIP server. (Transceiver Controller > Transceiver Settings > Transceiver Management)

TOP

### ■ MAC Address

Displays the MAC Address (LAN/WAN.)

MAC Address	
LAN	00-90-C7-XXXXXX
WAN	00-90-C7-XXXXXX

① The MAC address is the peculiar number that is assigned to a networking device. It is displayed in 12 hexadecimal (00-90-C7-XX-XX-XX).

① The MAC address is also printed on the label on the bottom of the RoIP gateway.

TOP screen

TOP

## ■ WAN Status

Displays the WAN connection status that is set on the “WAN” screen setting in the Router Settings menu. (Router Settings > WAN)

WAN Status	
Connection Type	DHCP Client
Nickname	eth0
Connection Status	
IP Address	
Default Gateway	
DNS Server	

TOP

## ■ LTE Status

Displays the LTE information, such as RSSI Level, if a nanoSIM card is installed.

LTE Status	
1 Network Status	4G
2 RSSI Level	High
3 Connection Status	Connected
4 Last Access time to the Server	9:25:26
5 Check the Server Connection	<input type="button" value="Check"/>

- 1 **Network Status** ..... Displays the type of the connected telephone line, “4G” or “3G.”
- 2 **RSSI Level** ..... Displays the approximate RSSI (Received Signal Strength Indicator) level, “High,” “Middle,” “Low,” or “Out of range.”
- 3 **Connection Status**..... Displays the status of the 4G/3G line connection, “Initializing,” “Initialization failure,” “Connecting,” “Connected,” or “Disconnected.”
- 4 **Last Access time to the Server** ..... Displays the last accessed date and time to the transceiver controller.  
 ⓘ The date and time in the list shows the received log from the transceiver module.
- 5 **Check the Server Connection** ..... Click <Check> to check the connection to the IP Transceiver controller.

---

Network Status screen .....	2-2
■ Interface List.....	2-2
■ Ethernet Port Connection Status .....	2-2
■ DHCP Lease Status .....	2-2
SYSLOG screen .....	2-3
■ SYSLOG .....	2-3
Bridge Status screen .....	2-4
■ Bridge Status .....	2-4
■ Port Connection Status .....	2-5
PBX Status screen .....	2-6
■ Extension Group List .....	2-6
■ List of Extensions .....	2-7
Call Log screen.....	2-8
■ Call Log.....	2-8
Extension Status screen .....	2-9
■ Extension Status .....	2-9
LTE Status screen .....	2-10
■ LTE Module Status .....	2-10
■ SIM Status .....	2-10
■ LTE Status .....	2-11

## Network Status screen

Information > Network Status

### Interface List

Displays the details of the Interface Setting.  
(Network Settings > Static Routing > Routing Table > Interface)

Interface List		
Interface	IP Address	Subnet Mask
br-lan	192.168.0.1	255.255.255.0

Information > Network Status

### Ethernet Port Connection Status

Displays the transfer speed and the transfer type for the Ethernet Port.  
This is an example setting the WAN connection type as [LAN Port].

Ethernet Port Connection Status		
Interface	MAC Address	Link Status
LAN	00-90-C7-88-23-1C	100BASE-TX full-duplex
WAN / LAN		Link down

**TIP:**

- The RoIP Gateway's [LAN] ports are auto-negotiation enabled, and can automatically select the optimal speed and duplex mode if the peer devices are auto-negotiation enabled as well.
- We recommend that you always enable auto-negotiation on the peer devices.  
If a peer device is fixed to full-duplex mode, auto-negotiation enabled devices (including the RoIP Gateway) may generally take it for half-duplex mode, and cannot communicate properly.

Information > Network Status

### DHCP Lease Status

Displays the IP Address and Lease Time assigned to the connected devices.

DHCP Lease Status			
Host Name	MAC Address	IP Address	Lease Time
192.168.0.30	00-90-C7-88-23-1C	192.168.0.30	00:00:00:00:00:00

## SYSLOG screen

Information > SYSLOG

### ■ SYSLOG

Displays the log of the RoIP Gateway.

The screenshot shows the SYSLOG interface. At the top, it displays the current time and uptime: "Current Time : [redacted] (Uptime: 0 day 02:14:18)". Below this, there are three severity checkboxes: "Severity : 1 [checked] DEBUG [checked] INFO [checked] NOTICE". A "Display Filter" field with a dropdown menu set to "Include" is also present. To the right of the filter are three buttons: "Refresh" (3), "Save" (4), and "Clear" (5). Below these controls is a table with three columns: "Date (Month-Day) and Time", "Severity", and "Description". The table contains one entry: "11-26 10:00:03", "INFO", and "telephonyd: unable to snd\_pcm\_writei err: Broken pipe".

- 1 **Severity** ..... Select one or more log types that you want to list.
  - ⓘ Remove the check mark to hide the entries.
  - ⓘ The selection is not stored, and will reset when you leave this screen.
  
- 2 **Display Filter** ..... Enter a keyword (for example: dhcp) and select "Include" or "Exclude" to narrow down the list.
  
- 3 **<Refresh>** ..... Click to reload the list. Up to the last 1000 logs are listed.
  
- 4 **<Save>** ..... Click to save a log to a text (.txt) file.
  
- 5 **<Clear>** ..... Click to clear all the logs.

## Bridge Status screen

Information > Bridge Status

### ■ Bridge Status

Displays the bridge connection status list, if a bridge destination network address is set.  
(See also section 5 in this manual for the Bridge Connection.)

① The Transceiver Controller is set to each port by default.

Bridge Status								
Port Name	Bridge Destination	Transmission Mode	Destination Address	Port Number		Voice Protocol	AMBE+2 Vocoder Assignment	Connection Status
				Destination	My Station			
Digital Transceiver1 (D-TRX1)	Digital Transceiver4 (D-TRX4)	-	-	-	-	-	Not Assigned	-
Digital Transceiver2 (D-TRX2)	Custom Bridge Connection	Unicast	192.168.1.200	23002	23002	Bridge Protocol	Internal	Inactive
Digital Transceiver3 (D-TRX3)	Transceiver Controller	-	-	-	-	-	Internal	-
Digital Transceiver4 (D-TRX4)	Digital Transceiver1 (D-TRX1)	-	-	-	-	-	Not Assigned	-
EXT I/O1 (EXT1)	Transceiver Controller	-	-	-	-	-	Not Assigned	-
EXT I/O2 (EXT2)	Transceiver Controller	-	-	-	-	-	Not Assigned	-
EXT I/O3 (EXT3)	Transceiver Controller	-	-	-	-	-	Not Assigned	-
EXT Input4 (EXT4)	Transceiver Controller	-	-	-	-	-	Not Assigned	-
EXT Output4 (EXT4)	Transceiver Controller	-	-	-	-	-	Not Assigned	-
Emergency Notification	Transceiver Controller	-	-	-	-	-	Not Assigned	-
Microphone (MIC)	Custom Bridge Connection	Multicast	239.255.255.1	22510	22510	G.711u	Not Assigned	Inactive
RoIP Gateway1	Transceiver Controller	-	-	-	-	-	-	-
RoIP Gateway2	Transceiver Controller	-	-	-	-	-	-	-
RoIP Gateway3	Transceiver Controller	-	-	-	-	-	-	-
RoIP Gateway4	Transceiver Controller	-	-	-	-	-	-	-
RoIP Gateway5	Transceiver Controller	-	-	-	-	-	-	-
RoIP Gateway6	Transceiver Controller	-	-	-	-	-	-	-
RoIP Gateway7	Transceiver Controller	-	-	-	-	-	-	-
RoIP Gateway8	Transceiver Controller	-	-	-	-	-	-	-

(This is only an example.)

## Bridge Status screen

Information > Bridge Status

### ■ Port Connection Status

Displays the connection status of each port.

Port Connection Status							
Port Name	Transmission Mode	Destination Address	Port Number		Voice Protocol	AMBE+2 Vocoder Assignment	Connection Status
			Destination	My Station			
RoIP Gateway1	-	-	-	-	-	Not Assigned	-
RoIP Gateway2	-	-	-	-	-	Not Assigned	-
RoIP Gateway3	-	-	-	-	-	Not Assigned	-
RoIP Gateway4	-	-	-	-	-	Not Assigned	-
RoIP Gateway5	-	-	-	-	-	Not Assigned	-
RoIP Gateway6	-	-	-	-	-	Not Assigned	-
RoIP Gateway7	-	-	-	-	-	Not Assigned	-
RoIP Gateway8	-	-	-	-	-	Not Assigned	-
Converter Bridge1	-	-	-	-	-	Not Assigned	-
Converter Bridge2	-	-	-	-	-	Not Assigned	-
Converter Bridge3	-	-	-	-	-	Not Assigned	-
Converter Bridge4	-	-	-	-	-	Not Assigned	-
Converter Bridge5	-	-	-	-	-	Not Assigned	-
Converter Bridge18	-	-	-	-	-	Not Assigned	-
Converter Bridge19	-	-	-	-	-	Not Assigned	-
Converter Bridge20	-	-	-	-	-	Not Assigned	-

(This is only an example.)

- RoIP Gateway 1 ~ 8 displays the status of the RoIP Gateway Connection settings.  
(Connection Port Settings > RoIP Gateway > RoIP Gateway Connection)
- Converter Bridge 1 ~ 20 displays the status of the Connection settings.  
(PBX Extension > Converter Bridge > Connection)
- Voice Protocol and the AMBE+2 Vocoder Assignment display the status of the AMBE+2 Vocoder Assignment settings.  
(Bridge Connection Setting > Bridge Connection > AMBE+2 Vocoder Assignment)

## PBX Status screen

Information > PBX Status

### ■ Extension Group List

Displays the Extension Group List status.

Extension Group List		
Extensions not Belonging to a Group <sup>1</sup>		41 42 43 44 45 3000
200 <sup>2</sup> (Sales)	Extensions <sup>3</sup>	31 32
	First call	31
	Second call <sup>4</sup>	32
	Third call	None
210 (Planning)	Extensions	33 34
	Sequentially call	33 34
99	Extensions	

- 1 Extensions not Belonging to a Group** ..... Displays the Extension Numbers that do not belong to any Extension Group.
- 2 Extension Group Number** ... Displays the Extension Group Number and its Group Name.
- 3 Extensions** ..... Displays the Extension Numbers that belongs to the Extension Group.
- 4 Setting for Extension Prioritization** ..... Displays the prior extensions to receive a call from the Extension Group Number (2).



PBX Status screen

Information > PBX Status

## List of Extensions

Displays the Extension settings.

List of Extensions			
31 (Sales 01) ①	Extension Group Number ②	200	
	Port Type ③	SIP Phone (Automatic Detection)	
	Dial-in number ④	None	
	Automatic Acquisition Line Number ⑤	IP Line	No use
		Peer to Peer	No use
	Connection from WAN ⑥	Deny	
	MAC Address ⑦	XXXXXXXXXX	
	IP Address ⑧	192.168.1.10	
32	Extension Group Number	200	

(This is only an example.)

- ① **Extension Number** ..... Displays the Extension number and the name.  
(PBX > Extension > Extension)
  
- ② **Extension Group Number** ..... Displays the Extension Group number.  
① Displays "No Extension Representative" when the Extension Numbers that do not belong to any Extension Group make a call.
  
- ③ **Port Type** ..... Displays the port type of the extension.
  
- ④ **Dial-in number** ..... Displays the dial-in number, if entered.
  
- ⑤ **Automatic Acquisition Line Number** ..... Displays whether or not to automatically acquire a specific telephone line.
  
- ⑥ **Connection from WAN** ..... Displays whether or not to allow connecting the Extension number from the WAN.
  
- ⑦ **MAC Address** ..... Displays the MAC address of the extension.
  
- ⑧ **IP Address** ..... Displays IP Address used by the extension.
  - Displays "Disconnected" when the extension does not connect to the RoIP Gateway.
  - Displays "-" when you connect to the Transceiver Controller Telephone Connection or the Converter Bridge.

## Call Log screen

Information > Call Log

### ■ Call Log

Lists the log of the Bridge connection to the RoIP gateway and the telephone communication.

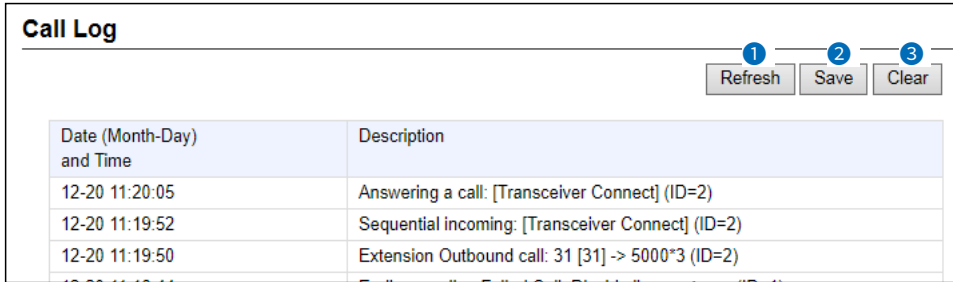

Date (Month-Day and Time)	Description
12-20 11:20:05	Answering a call: [Transceiver Connect] (ID=2)
12-20 11:19:52	Sequential incoming: [Transceiver Connect] (ID=2)
12-20 11:19:50	Extension Outbound call: 31 [31] -> 5000*3 (ID=2)

- ① <Refresh> ..... Click to reload the list. Up to the last 1000 logs are listed.
- ② <Save> ..... Click to save a log to a text (.txt) file.
- ③ <Clear> ..... Click to delete all the logs.

## Extension Status screen

Information > Extension Status

### ■ Extension Status

Displays the status of the Extension.  
(PBX > Extension > Extension)

Extension Status					
1 Name	2 Extension Number	3 Port Type	4 Version	5 IP Address	6 Presence
Sales 01	31	SIP Phone (Automatic Detection KX-HDV Series)		192.168.0.	Online
Sales 02	32	SIP Phone (Automatic Detection KX-UT Series)		192.168.0.	Online
Sales 03	33	SIP Phone (Automatic Detection)			Offline
Sales 04	34	SIP Phone (Automatic Detection)			Offline
	3000	Transceiver Controller Telephone Connection			
	4001	Converter Bridge			

- 1 Name** ..... Displays the Extension number and the name assigned to Extension settings.  
(PBX > Extension > Extension)
- 2 Extension Number** ..... Displays the extension number assigned to Extension.  
(PBX > Extension > Extension)
- 3 Port Type** ..... Displays the port type of the extension assigned to Extension settings.  
(PBX > Extension > Extension).
- 4 Version** ..... Displays the Firmware information for VoIP Expansion.  
① Displayed when a SIP phone is displayed to only the Port Type Setting(3).
- 5 IP Address** ..... Displays the IP Address used by VoIP Expansion.  
① Displayed when a SIP phone is displayed to only the Port Type Setting(3).
- 6 Presence** ..... Displays the status of the VoIP Expansion.

  - Offline: Not registered.
  - Online\*: Registered.
  - On the phone\*: Calling or holding.
  - Step out\*: Call forwarding except for the transceivers.

\*Online, On the phone, and Step out is displayed when successfully registered.  
① Displayed when a SIP phone is displayed to only the Port Type Setting(3).

## LTE Status screen

Information > LTE Status

### ■ LTE Module Status

Displays the information of the LTE communication module.

LTE Module Status	
Version ①	XXXXXXXXXXXX
IMEI ②	XXXXXXXXXXXX

- ① **Version** ..... Displays the version of the LTE communication module.
- ② **IMEI** ..... Displays the communication module's IMEI (International Mobile Equipment Identifier.)

Information > LTE Status

### ■ SIM Status

Displays the information of the SIM.

SIM Status	
① Active SIM Slot	SIM1
② ICCID	-
③ Phone Number	-

- ① **Active SIM Slot** ..... Displays the SIM slot number in use.
- ② **ICCID** ..... Displays the ICCID (IC Card Identifier) of the installed SIM card.  
 ⓘ Displayed when information of Active SIM Slot Setting (①) can be acquired.
- ③ **Phone Number** ..... Displays the telephone number of the SIM card.  
 ⓘ Displayed when information of Active SIM Slot Setting (①) can be acquired.

LTE Status screen

Information > LTE Status

## ■ LTE Status

Displays the information of the LTE line if installed and valid.

LTE Status	
1 Network Status	4G
2 RSSI Level	High
3 Connection Status	Connected
4 Last Access time to the Server	18:25

- 1 **Network Status** ..... Displays the type of the connected telephone line, “4G” or “3G.”
- 2 **RSSI Level** ..... Displays the approximate RSSI level, “High,” “Middle,” “Low,” or “Out of range.”
- 3 **Connection Status**..... Displays the status of the 4G/3G line connection, “Initializing,” “Initialization failure,” “Connecting,” “Connected,” or “Disconnected.”
- 4 **Last Access time to the Server** ..... Displays the last accessed date and time to the IP transceiver controller.  
① The date and time in the list displayed here are acquired from the transceiver module.

---

IP Address screen .....	3-2
■ Host Name .....	3-2
■ IP Address .....	3-3
DHCP Server screen .....	3-4
■ DHCP Server .....	3-4
■ Static DHCP .....	3-7
■ List of Static DHCP Settings .....	3-7
Static Routing Screen .....	3-8
■ Routing Table .....	3-8
■ Static Routing .....	3-9
■ List of Static Routing Entries .....	3-9
Policy Routing screen .....	3-10
■ Source Address Routing .....	3-10
■ List of Source Address Routing Entries .....	3-10

## IP Address screen

Network Settings > IP Address

### ■ Host Name

Enter the host name.

<b>Host Name</b>
Host Name : <u>VE-PG4</u>

**Host Name** .....

Enter a host name of up to 31 characters. (Default: VE-PG4)  
When the RoIP Gateway connects to Telnet/SSH, this host name is displayed.  
① The usable characters are: "a" ~ "z", "A" ~ "Z", "0" ~ "9", and "-."  
① The name must start with an alphanumeric character, and must NOT start or end with a "-."

IP Address screen

Network Settings > IP Address

## ■ IP Address

Enter the VE-PG4's IP Address.

**IP Address**

IP Address : ① 192.168.0.1  
Subnet Mask : ② 255.255.255.0  
Default Gateway : ③  
Primary DNS Server : ④  
Secondary DNS Server : ⑤

⑥ Apply ⑦ Reset

- ① **IP Address** ..... Enter the LAN IP address according to your network environment.  
(Default: 192.168.0.1)  
① When using the DHCP Server function, the network part of the IP address must be the same as that set in the "IP Pool Start Address" item in the [DHCP Server] menu.
- ② **Subnet Mask** ..... Enter the subnet mask according to your network environment.  
(Default: 255.255.255.0)
- ③ **Default Gateway** ..... If a default gateway device, such as a router, is connected to the LAN port, enter the device's IP address.
- ④ **Primary DNS Server** ..... Enter the DNS server address specified by your service provider. If you have two DNS server addresses, enter the primary address.
- ⑤ **Secondary DNS Server** ... If you have two DNS server addresses, enter the secondary DNS server address.
- ⑥ **<Apply>** ..... Click to apply the entries.
- ⑦ **<Reset>** ..... Click to reset the settings.  
① You cannot reset after clicking <Apply>.



## DHCP Server screen

Network Settings > DHCP Server

### DHCP Server

Configure the DHCP Server function.

**DHCP Server**

DHCP Server: ①  Disable  Enable

IP Pool Start Address: ②

Pool Size: ③

Subnet Mask: ④

Lease Time: ⑤  hours

Domain Name: ⑥

Default Gateway: ⑦

- ① **DHCP Server** ..... Select "Enable" to use the DHCP Server function. (Default: Disable)  
The DHCP Server is activated, depending on the IP Pool Start Address (②) and Pool Size (③) items.
  
- ② **IP Pool Start Address** ..... Enter the IP Pool Start address. (Default: 192.168.0.10)  
An IP address is automatically assigned to a transceiver that the RoIP Gateway connects to, from this IP Pool Start address.
  
- ③ **Pool Size** ..... Entry the number of an IP address that can be automatically assigned. (Default: 30)  
Up to 128 addresses can be automatically assigned by the DHCP server function. Another 32 addresses can be manually assigned.
  
- ④ **Subnet Mask** ..... Enter the subnet mask for the IP Pool Start address set in the "IP Pool Start Address" (②). (Default: 255.255.255.0)
  
- ⑤ **Lease Time** ..... Enter the lease time period. (Default: 72)  
Range: 1 ~ 9999 (hours)
  
- ⑥ **Domain Name** ..... Enter a network address domain name of up to 253 characters.
  
- ⑦ **Default Gateway** ..... Enter the default gateway IP address.  
When the DHCP Server function is used, this IP address is sent to a client.  
① When this item is blank, the RoIP Gateway's IP address is sent.

DHCP Server screen

Network Settings > DHCP Server

■ DHCP Server

The screen above shows when “DNS Proxy” (8) is set to “Disable.”

- 8 **DNS Proxy** ..... Selects whether or not to use a DNS proxy. (Default: Enable)  
When this option is set to “Enable,” the terminals can assign the RoIP Gateway as the DNS server.
- 9 **Primary DNS Server** ..... (Displayed only when the DNS Proxy (8) is disabled)  
Enter the DNS server address specified by your service provider.  
If you have two DNS server addresses, enter the primary address.
- 10 **Secondary DNS Server** ... (Displayed only when the DNS Proxy (8) is disabled)  
If you have two DNS server addresses, enter the secondary DNS server address.
- 11 **Primary WINS Server** ..... Enter the WINS server’s address. If you have two WINS server addresses, enter the primary address.
- 12 **Secondary WINS Server** ... If you have two WINS server addresses, enter the WINS server’s secondary address.

DHCP Server screen

Network Settings > DHCP Server

■ DHCP Server

The screen above shows when “DNS Proxy” (8) is set to “Disable.”

- 13 TFTP Server Distribution ...** Set to “Enable” to use a provisioning KX Series telephone. (Default: Enable)  
When this option is enabled, the telephone automatically reads the setting from the RoIP Gateway and sets up by itself.  
① The telephone’s MAC address must be entered on the “Extension” screen.  
① When using this system with static IP addresses, see also Section 4 in the Installation guide.
- 14 TFTP Server Address .....** Enter the IP address of the TFTP server for the KX series telephone. If this item is blank, the RoIP Gateway works as the TFTP server. (Default: Blank)
- 15 <Apply> .....** Click to apply the entries.
- 16 <Reset> .....** Click to reset the settings.  
① You cannot reset after clicking <Apply>.

## DHCP Server screen

Network Settings > DHCP Server

### ■ Static DHCP

Enter the MAC and static IP addresses of the DHCP server.

① You can enter up to 32 entries.

Static DHCP		
MAC Address	IP Address	
<input type="text"/>	<input type="text"/>	<input type="button" value="Add"/>

**Static DHCP** .....

Enter the MAC and IP addresses, and then click <Add>.

① This setting is useful when the DHCP Server function is used. See page 3-4 for details of the DHCP Server function.

① Sets a different IP address from the IP address that the DHCP Server function automatically assigns.

① Make sure that the addresses of the devices on the network do not overlap or conflict.

If a DHCP server is already connected to the network, and there is an address conflict, a network problem will occur.

### ■ List of Static DHCP Settings

Displays the static DHCP entries.

List of Static DHCP Settings		
MAC Address	IP Address	
00-90-C7- <input type="text"/>	192.168.0.150	<input type="button" value="Delete"/>

**<Delete>** .....

Click to delete the entry.

① You cannot restore after clicking <Delete>.

## Static Routing Screen

Network Settings > Static Routing

### ■ Routing Table

Displays the valid routing information for packet transmission.

Routing Table			
Destination ①	Subnet Mask ②	Gateway ③	Interface ④
192.168.0.0	255.255.255.0		br-lan
192.168.10.0	255.255.255.0	192.168.0.254	br-lan

- ① **Destination** ..... The network address of the route's destination network.
- ② **Subnet Mask** ..... The subnet mask of the route's destination network.
- ③ **Gateway** ..... The route's gateway address.
- ④ **Interface** ..... The routing interface.
  - **br-lan:** LAN
  - **eth0:** WAN
  - **ppp0 ~ ppp7:** PPPoE (WAN)
  - **vti0 ~ vti 31:** IPsec Tunnel

## Static Routing Screen

Network Settings > Static Routing

### Static Routing

Enter the static routing destinations.

① You can enter up to 32 entries.

Static Routing				
Destination ①	Subnet Mask ②	Gateway ③	Interface ④	⑤
192.168.10.0	255.255.255.0	192.168.0.254	Set the gateway ▾	Add

- ① **Destination** ..... The network address of the route's destination network.
- ② **Subnet Mask** ..... The subnet mask of the route's destination network.
- ③ **Gateway** ..... (Only when the Interface (④) is set to "Set the gateway")  
Set the route's gateway address.
- ④ **Interface** ..... The routing interface.
  - Set the gateway
  - ppp0 (WAN01) ~ ppp7 (WAN08)
  - vti0 ~ vti 31
- ⑤ **<Add>** ..... Click to add the entry.  
The entry that is registered in the [List of Static Routing Entries] is displayed.

### List of Static Routing Entries

Displays the static routing destinations.

① You can enter up to 32 entries.

List of Static Routing Entries				
Destination	Subnet Mask	Gateway	Interface	① ②
192.168.10.0	255.255.255.0	192.168.0.254		Edit Delete

- ① **<Edit>** ..... Click to edit the entry.
- ② **<Delete>** ..... Click to delete the entry.  
① You cannot restore after clicking <Delete>.

## Policy Routing screen

Network Settings > Policy Routing

### ■ Source Address Routing

Enter the packet source routing from the specified network address of the source terminal (such as a PC.)

① You can enter up to 32 entries.

Source Address Routing				
Source Address ①	Subnet Mask ②	Gateway ③	Interface ④	⑤
192.168.0.20	255.255.255.255		ppp1 (WAN02) ▾	Add

- ① **Source Address** ..... Set the network address of the source terminal.
- ② **Subnet Mask** ..... Set the subnet mask of the source network address.
- ③ **Gateway** ..... (Only when the Interface (④) is set to “Set the gateway”)  
Set the route’s gateway address.
- ④ **Interface** ..... The routing target interface from:
  - Set the gateway
  - ppp0 (WAN01) ~ ppp7 (WAN08)
  - vti0 ~ vti31
- ⑤ **<Add>** ..... Click to add the entry.  
The entry that is registered in the [List of Source Address Routing Entries] is displayed.

### ■ List of Source Address Routing Entries

Displays the entered packet source routing settings.

List of Source Address Routing Entries				
Source Address	Subnet Mask	Gateway	Interface	① ②
192.168.0.20	255.255.255.255		ppp1 (WAN02)	Edit Delete

- ① **<Edit>** ..... Click to edit the entry.
- ② **<Delete>** ..... Click to delete the entry.  
① You cannot restore after clicking <Delete>.

---

WAN screen .....	4-2
■ Connection Status .....	4-2
■ Connection Type .....	4-6
■ Connection Settings .....	4-7
■ List of Connection Settings .....	4-12
NAT screen .....	4-13
■ NAT .....	4-13
■ DMZ Host .....	4-13
■ Port Forwarding .....	4-14
■ List of Port Forwarding Entries .....	4-15
IP Filter screen .....	4-16
■ General Settings .....	4-16
■ IP Filter .....	4-17
■ List of IP Filter Entries .....	4-22
Simple DNS screen .....	4-23
■ Simple DNS Server Setting .....	4-23
■ List of Simple DNS Server Settings .....	4-23
VPN screen .....	4-24
■ IPsec Settings .....	4-24
■ IPsec Tunnel Settings.....	4-25
■ List of IPsec Tunnel Settings.....	4-27



## WAN screen

Router Settings > WAN

### ■ Connection Status

(When “Connection Type” is set to “LAN port”)  
The WAN connection status is displayed.

Connection Status	
1 Connection Status	
2 Connection Type	LAN Port
3 IP Address	
4 Peer IP Address	
5 DNS Server	

- 1 **Connection Status**..... Nothing is displayed.
- 2 **Connection Type** ..... The WAN connection type is displayed.
- 3 **IP Address** ..... Nothing is displayed.
- 4 **Peer IP Address** ..... Nothing is displayed.
- 5 **DNS Server** ..... Nothing is displayed.

## WAN screen

### Router Settings > WAN

#### ■ Connection Status

(When “Connection Type” is set to “DHCP Client”)  
The WAN connection status is displayed.

Connection Status	
1 Connection Status	Connected
2 Connection Type	DHCP Client
3 IP Address	192.168.1.10
4 Peer IP Address	192.168.1.1
5 DNS Server	192.168.1.1

- 1 **Connection Status**..... The connection status to the Internet line is displayed as “Unplugged,” “Connecting,” or “Connected.”
- 2 **Connection Type** ..... The WAN connection type is displayed.
- 3 **IP Address** ..... The RoIP Gateway’s IP address is displayed.
- 4 **Peer IP Address** ..... The default Gateway IP address specified by your service provider is displayed.
- 5 **DNS Server** ..... The DNS server’s IP address is displayed.

## WAN screen

### Router Settings > WAN

#### ■ Connection Status

(When “Connection Type” is set to “Static IP”)  
The WAN connection status is displayed.

Connection Status		
1	Connection Status	Connected
2	Connection Type	Static IP
3	IP Address	192.168.1.1
4	Peer IP Address	192.168.1.1
5	DNS Server	192.168.1.1

- 1 **Connection Status**..... The connection status to the Internet line is displayed as “Unplugged,” or “Connected.”
- 2 **Connection Type** ..... The WAN connection type is displayed.
- 3 **IP Address** ..... The RoIP Gateway’s IP address is displayed.
- 4 **Peer IP Address** ..... The default Gateway IP address specified by your service provider is displayed.
- 5 **DNS Server** ..... The DNS server’s IP address is displayed.

## WAN screen

### Router Settings > WAN

#### ■ Connection Status

(When “Connection Type” is set to “PPPoE”)

The WAN connection status is displayed.

- ① Up to 2 PPPoE sessions can be connected from the registered PPPoE destination.
- ① The first session is set to the default gateway.
- ① To use a second session, set the Static Routing and the Policy Routing.

Connection Status		
	Session 1	Session 2
① PPPoE Session	Session 1	Session 2
② Destination	WAN01 (ppp0) <input type="button" value="Disconnect"/>	None <input type="button" value="Connect"/>
③ Connection Status	Connected	
④ Connection Type	PPPoE	PPPoE
⑤ IP Address	192.168.1.1	
⑥ Peer IP Address	192.168.1.1	
⑦ DNS Server	192.168.1.1, 192.168.1.1	
⑧ Uptime	0:00:00:00	

- ① **PPPoE Session** ..... The first session and the second session are displayed respectively.
- ② **Destination** ..... Select the destination from the WAN connection set in the [Connection Settings] setting (Router Settings > WAN > Connection Settings).
  - ① You cannot select while connecting the line.
  - <Connect>/<Disconnect>**  
Click to manually connect or disconnect the selected WAN.
  - ① <Disconnect> is displayed when the line is connected.
  - ① If “Connecting” is not displayed in [Connection Status] when the line is connected, check the cable connection and network configuration.
- ③ **Connection Status**..... The connection status to the Internet line is displayed as “Unplugged,” “Disconnect,” “Connecting,” or “Connected.”
- ④ **Connection Type** ..... The WAN connection type is displayed.
- ⑤ **IP Address** ..... The RoIP Gateway’s IP address is displayed.
- ⑥ **Peer IP Address** ..... The default Gateway IP address specified by your service provider is displayed.
- ⑦ **DNS Server** ..... The DNS server’s IP address is displayed.
- ⑧ **Uptime** ..... The elapsed time the RoIP Gateway has been connected to the network is displayed.

WAN screen

Router Settings > WAN

## ■ Connection Type

WAN/LAN port settings.

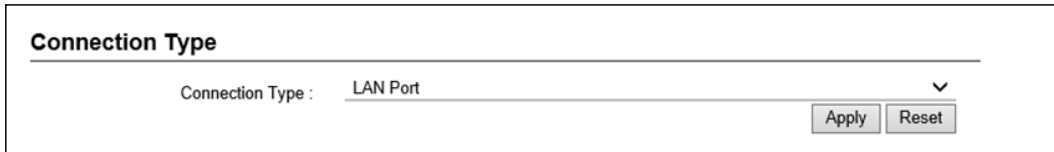

Connection Type

Connection Type : LAN Port

Apply Reset

**Connection Type** ..... Select the WAN connection type as specified by your service provider.  
(Default: LAN Port)

- **LAN Port:** Switching the [LAN] port to connect to other devices.
- **DHCP Client:** The WAN IP address is automatically obtained by a DHCP server.
- **Static IP:** The WAN IP address is specified by your service provider.
- **PPPoE:** The WAN IP address is specified by your service provider using the PPPoE method.

WAN screen

Router Settings > WAN

### ■ Connection Settings

(When “Connection Type” is set to “DHCP Client”)  
Set the WAN.

**Connection Settings**

Nickname : ① \_\_\_\_\_

Primary DNS Server : ② \_\_\_\_\_

Secondary DNS Server : ③ \_\_\_\_\_

④ Apply ⑤ Reset

- ① **Nickname** ..... Enter your service provider’s name of up to 31 characters.
- ② **Primary DNS Server** ..... Enter the DNS server address specified by your service provider. If you have two DNS server addresses, enter the primary address.
- ③ **Secondary DNS Server** ... If you have two DNS server addresses, enter the secondary DNS server address.
- ④ **<Apply>** ..... Click to apply the entries.
- ⑤ **<Reset>** ..... Click to reset the settings.  
ⓘ You cannot reset after clicking <Apply>.

## WAN screen

### Router Settings > WAN

#### ■ Connection Settings

(When “Connection Type” is set to “Static IP”)  
Set the WAN.

**Connection Settings**  
Nickname : ① \_\_\_\_\_  
IP Address : ② \_\_\_\_\_  
Subnet Mask : ③ \_\_\_\_\_  
Default Gateway : ④ \_\_\_\_\_  
Primary DNS Server : ⑤ \_\_\_\_\_  
Secondary DNS Server : ⑥ \_\_\_\_\_  
⑦ Apply    ⑧ Reset

- ① **Nickname** ..... Enter your service provider’s name of up to 31 characters.
- ② **IP Address** ..... Enter the WAN IP address.
- ③ **Subnet Mask** ..... Enter the WAN Subnet Mask
- ④ **Default Gateway** ..... Enter the WAN Default Gateway.
- ⑤ **Primary DNS Server** ..... Enter the DNS server address specified by your service provider.  
If you have two DNS server addresses, enter the primary address.
- ⑥ **Secondary DNS Server** ... If you have two DNS server addresses, enter the secondary DNS server address.
- ⑦ **<Apply>** ..... Click to apply the entries.
- ⑧ **<Reset>** ..... Click to reset the settings.  
① You cannot reset after clicking <Apply>.

## WAN screen

### Router Settings > WAN

#### ■ Connection Settings

(When “Connection Type” is set to “PPPoE”)  
Set the WAN.

- 1 Select Connection** ..... Select the WAN connection. (Up to 8 settings can be set.)  
(Default: WAN01(ppp0))
- 2 Nickname** ..... Enter or edit your service provider’s name of up to 31 characters.  
① The nickname set in [Select Connection] is displayed.
- 3 User Name** ..... Enter the login user name or the account name.
- 4 Password** ..... Enter a login password.  
The entered characters are displayed as \* (asterisk) or ● (black circle.)
- 5 Reconnect Mode** ..... Select the PPPoE connection method. (Default: Always-ON)

  - **Manual:** The PPPoE line can be manually connected, by clicking <Connect>/<Disconnect>  
① The network is disconnected, when the RoIP Gateway is booted.
  - **Always-ON:** The PPPoE line is always connected to the destination set in the [Select Connection].  
① The network is already connected when the RoIP Gateway is booted.  
① You can manually connect or disconnect by clicking <Connect> or <Disconnect> in the “Connection Status” setting (Router Settings > WAN > Connection Status).



## WAN screen

### Router Settings > WAN

#### ■ Connection Settings

(When “Connection Type” is set to “PPPoE”)

**Connection Settings**

Select Connection : 1 WAN01 (ppp0) ▼

Nickname : 2 WAN01

Username : 3

Password : 4

Reconnect Mode : 5 Always-ON ▼

IP Address : 6

Primary DNS Server : 7

Secondary DNS Server : 8

Authentication Protocol : 9 Automatic ▼

MSS Limit : 10 1322

11 12

Apply Reset

- 6 **IP Address** ..... Enter the WAN IP address only if it is specified by your service provider.
- 7 **Primary DNS Server** ..... Enter the DNS server address specified by your service provider. If you have two DNS server addresses, enter the primary address.
- 8 **Secondary DNS Server** ... If you have two DNS server addresses, enter the secondary DNS server address.
- 9 **Authentication Protocol** ... Enter the authentication protocol specified by your service provider. Select “Automatic” if not specified. (Default: Automatic)
  - **Automatic:** Change PAP/CHAP automatically according to the destination’s request.
  - **PAP:** Use a password for the authentication. Note that the password is not encrypted.
  - **CHAP:** The authentication information is encrypted. It is more secure than PAP.

## WAN screen

### Router Settings > WAN

#### ■ Connection Settings

(When “Connection Type” is set to “PPPoE”)

**Connection Settings**

Select Connection : ① WAN01 (ppp0) ▼

Nickname : ② WAN01

Username : ③

Password : ④

Reconnect Mode : ⑤ Always-ON ▼

IP Address : ⑥

Primary DNS Server : ⑦

Secondary DNS Server : ⑧

Authentication Protocol : ⑨ Automatic ▼

MSS Limit : ⑩ 1322

⑪ Apply ⑫ Reset

- ⑩ **MSS Limit**..... Enter the MSS Limit, if specified by your service provider. (Default: 1322)  
• Range: 536 ~ 1452 (byte)
- ⑪ **<Apply>** ..... Click to apply the entries.
- ⑫ **<Reset>** ..... Click to reset the settings.  
ⓘ You cannot reset after clicking <Apply>.

## WAN screen

Router Settings > WAN

### ■ List of Connection Settings

(When “Connection Type” is set to “PPPoE”)

Lists the connection destinations registered in “Connecting Settings”. (Router Settings > WAN > Connection Settings)

List of Connection Settings			
Nickname	Username	Reconnect Mode	
WAN01(ppp0)	*****	Always-ON	Delete

<Delete> .....

Click to delete an entry.

① You cannot restore after clicking <Delete>.

## NAT screen

Router Settings > NAT

### NAT

Set the NAT.

① This function cannot be used when "LAN port" is selected in "Connection Type."

**NAT**..... Select "Enable" to use the NAT function. (Default: Enable)  
 The NAT function converts the WAN global address into a private address.

Router Settings > NAT

### DMZ Host

Set the DMZ Host function.

① This function cannot be used when "LAN port" is selected in "Connection Type."

**1 DMZ Host IP Address** ..... Enter the DMZ Host IP address.  
 The DMZ Host function (DeMilitarized Zone) transfers an unknown IP frame from the WAN (Internet) to the specified IP address on the LAN. But you need to pay attention because it also decreases the security of the IP address, which is specified as the transfer destination.  
 ① When the DMZ Host function and Port Forwarding are used at the same time, Port Forwarding is prioritized.  
 ① Icom is not responsible for any results caused by a decline in security.

**2 <Apply>** ..... Click to apply the entries.

**3 <Reset>** ..... Click to reset the settings.  
 ① You cannot reset after clicking <Apply>.

## NAT screen

Router Settings > NAT

### ■ Port Forwarding

The Port Forwarding function forwards the packets from a masquerade IP (Router Global IP) address to a private IP address.

Port Forwarding				
WAN Port <b>1</b>	LAN IP Address <b>2</b>	LAN Port <b>3</b>	Protocol <b>4</b>	<b>5</b>
Custom ▾		Custom ▾	TCP ▾	Add

- 1 WAN Port** ..... Select "Custom" if you select the WAN port by its number.  
If you don't select the port by number, select the port by the mnemonic (DNS, Finger, FTP, Gopher, NEWS, POP3, SMTP, Telnet, Web, or Whois).
- 2 LAN IP Address** ..... Enter the private IP address.
- 3 LAN Port** ..... Select "Custom" if you select the LAN port by its number.  
If you don't select the port by number, select the port by the mnemonic (DNS, Finger, FTP, Gopher, NEWS, POP3, SMTP, Telnet, Web, or Whois).
- 4 Protocol** ..... Select the protocol from "TCP," "UDP," "TCP/UDP," "GRE," and "ESP."
- 5 <Add>** ..... Click to add the entry.  
① Up to 32 masquerade IP addresses can be registered.

## NAT screen

Router Settings > NAT

### List of Port Forwarding Entries

Lists the Port Forwarding Entries.

WAN Port	LAN IP Address	LAN Port	Protocol	①	②
Web	192.168.0.100	Web	TCP/UDP	Edit	Delete
FTP	192.168.0.200	FTP	TCP/UDP	Edit	Delete

① <Edit> .....

Click to edit the entry.  
① The registered entries are displayed in [Port Forwarding].

② <Delete> .....

Click to delete the entry.  
① You cannot restore after clicking <Delete>.

## IP Filter screen

Router Settings > IP Filter

### ■ General Settings

The settings to pass or block the packets that match the registered filtering settings.

- ① When [LAN Port] is set in Connection type, this setting cannot be changed.
- ① Icom is not responsible for any results caused by a decline in security due to changing the IP filter.

**General Settings**

---

Block Action : ①  Drop  Reject

Syslogging Unmatched Packets : ②  Disable  Enable

③
④

- ① **Block Action** ..... Select the operation when blocking the packet. (Default: Drop)
  - **Drop:** Dropping the packet without any response.
  - **Reject:** Sending the denied packet.
  
- ② **Syslogging Unmatched Packets** ..... Select whether or not to log the packets started from the WAN and blocked due to not matching any IP filter. (Default: Disable)
  - ① Processing a large number of logs may decrease the processing speed.
  
- ③ **<Apply>** ..... Click to apply the settings.
  
- ④ **<Reset>** ..... Click to reset the settings.
  - ① You cannot reset after clicking <Apply>.

## IP Filter screen

Router Settings > IP Filter

### IP Filter

The settings to pass or block the packets that match the registered filtering settings.

① When [LAN Port] is set in Connection type, this setting cannot be changed.

① Icom is not responsible for any results caused by a decline in security due to changing the IP filter.

① This is an example of setting "TCP" as the protocol.

- 1 No.** ..... Select the filtering order. (Default: 1)

  - Range: 1 ~ 64
  - ① The number registered in [List of IP Filter Entries] cannot be selected.
  - The filter function checks the packets in the selected order according to the filter setting in [list of IP Filter Entries].
- 2 Entry** ..... Select "Enable" to apply the filter setting. (Default: Enable)

  - Select "Disable" in the unused filter entry.
  - If the filter is registered in "Disable," (OFF) is displayed in [No.] of [List of IP Filter Entries].
  - ① This is an example when number "1" is disabled.

No.	Action	Protocol (TCP Flags)	Source IP Address (Source Port)	Destination IP Address (Destination Port)	SYSLOG	
1 (off)	Pass	Any	*	*	Disable	Edit Delete
	In		(*)	(*)		

- 3 Action** ..... Select the filtering method. (Default: Pass)

  - **Block:** Blocks all packets that match the filtering settings.
  - **Pass:** Passes all packets that match the filtering settings.



## IP Filter screen

### Router Settings > IP Filter

#### ■ IP Filter

① This is an example of setting “TCP” as the protocol.

- ④ Direction** ..... Set the filtering direction. (Default: In)

  - **In:** Filters the incoming packets from the WAN interfaces.
  - **Out:** Filters the outgoing packets to the WAN interfaces.
  
- ⑤ Source IP Address**..... Enter the source IP address (and mask) to filter.  
All the packets sent from the entered IP address are filtered (blocked or passed.)

  - Mask range: 1 ~ 32
  
- ⑥ Destination IP Address** ... Enter the destination IP address (and mask) to filter.  
All the packets sent to the entered IP address are filtered (blocked or passed).

  - Mask range: 1 ~ 32
  
- ⑦ Protocol** ..... Select the transport layer protocol of the packet targeted to be filtered. (Default: Any)

  - **Any:** All protocols.
  - **TCP:** Only TCP.  
Enter [Source Port], [Destination Port], and [TCP Flags].
  - **UDP:** Only UDP.  
Enter [Source Port] and [Destination Port].

## IP Filter screen

### Router Settings > IP Filter

#### ■ IP Filter

① This is an example of setting “TCP” as the protocol.

#### ⑦ Protocol (Continued) .....

- **TCP/UDP:** TCP and UDP.  
Enter [Source Port] and [Destination Port].
- **ICMP:** Only ICMP.  
Enter [Type] and [Code].

Protocol :	ICMP	Custom Value :	
Type :			
Code :			

[Type]

Enter the type of ICMP header to filter between 0 and 255.

① When the type is not specified, all header types are filtered.

[Code]

Enter the type of ICMP code to filter between 0 and 255.

① When the type is not specified, all code types are filtered.

- **IGMP:** Only IGMP.
- **Custom:** Specified by the potocol number.  
Enter the upper IP layer protocol number into the [Cunstom Value].  
Range: 0 ~255

## IP Filter screen

### Router Settings > IP Filter

#### ■ IP Filter

① This is an example of setting “TCP” as the protocol.

#### ⑧ Source Port .....

Specify the source port, or enter the TCP/UDP source port number.  
(Default: Any)

There are 2 ways to specify the port number.

##### • Specifying by number

1. Select “Custom.”
2. Enter the custom port number in “Custom Value:[(Start)] - [(End)].”  
When you use a specific port, enter only the “[Start]”, or enter the same number in both the “[Start]” and the “[End].”  
Port number range: 1 ~ 65535

##### • Specifying by mnemonic

Select a source port other than “Any” or “Custom.”  
“DNS,” “Finger,” “FTP,” “Gopher,” “NEWS,” “POP3,” “SMTP,” “Telnet,” “Web,” “Whois” are selectable.

① When “Any” is selected, all of the port number types are filtered.

#### ⑨ Destination Port .....

Select the destination port, or enter the TCP/UDP destination port number.  
(Default: Any)

There are 2 ways to specify the port number.

##### • Specifying by number

1. Select “Custom.”
2. Enter the custom port number in “Custom Value:[(Start)] - [(End)].”  
When you use a specific port, enter only the “[Start]”, or enter the same number in both the “[Start]” and the “[End].”  
Port number range: 1 ~ 65535

##### • Specifying by mnemonic

Select a source port other than “Any” or “Custom.”  
“DNS,” “Finger,” “FTP,” “Gopher,” “NEWS,” “POP3,” “SMTP,” “Telnet,” “Web,” “Whois” are selectable.

① When “Any” is selected, all of the port number types are filtered.

## IP Filter screen

### Router Settings > IP Filter

#### ■ IP Filter

#### 10 TCP Flags.....

Select the TCP flags. (Default: None)

You can select the TCP flags from “URG,” “ACK,” “PSH,” “RST,” “SYN,” and “FIN.”

① The selected flag’s first character is displayed in [List of IP Filter Entries]. (Example: RST is selected)

2	Pass	TCP (R)	* (*)	Disable	Edit	Delete
	In		* (*)			

① When “None” is selected, the packet is filtered regardless of the TCP flags.

#### 11 SYSLOG .....

Select “Enable” to output the SYSLOG. (Default: Disable)

① The log information is displayed on the SYSLOG screen. (Information > SYSLOG)

① Processing a large number of logs may decrease the processing speed. Do not use this function except for the operation check and the test operation to ensure the call quality.

#### 12 <Apply> .....

Click to apply the entries.

#### 13 <Reset> .....

Click to reset the settings.

① You cannot reset after clicking <Apply>.

## IP Filter screen

Router Settings > IP Filter

### List of IP Filter Entries

Lists the IP filter entries registered in [IP filter] setting.

List of IP Filter Entries					
No.	Action	Protocol (TCP Flags)	Source IP Address (Source Port)	SYSLOG	<div style="display: flex; justify-content: space-around;"> <span>①</span> <span>②</span> </div>
	Direction		Destination IP Address (Destination Port)		
59	Block	TCP/UDP	* (135)	Disable	<div style="display: flex; justify-content: space-around;"> <span>Edit</span> <span>Delete</span> </div>
	Out		* (*)		
60	Block	TCP/UDP	* (*)	Disable	<div style="display: flex; justify-content: space-around;"> <span>Edit</span> <span>Delete</span> </div>
	Out		* (135)		
61	Block	TCP/UDP	* (445)	Disable	<div style="display: flex; justify-content: space-around;"> <span>Edit</span> <span>Delete</span> </div>
	Out		* (*)		
62	Block	TCP/UDP	* (*)	Disable	<div style="display: flex; justify-content: space-around;"> <span>Edit</span> <span>Delete</span> </div>
	Out		* (445)		
63	Block	TCP (Any Flag)	* (*)	Disable	<div style="display: flex; justify-content: space-around;"> <span>Edit</span> <span>Delete</span> </div>
	Out		* (137-139)		
64	Block	UDP	* (137-139)	Disable	<div style="display: flex; justify-content: space-around;"> <span>Edit</span> <span>Delete</span> </div>
	Out		* (137-139)		

① <Edit> .....

Click to edit the entry.  
 ① The entry contents are loaded to the IP Filter Setting.

② <Delete> .....

Click to delete the entry.  
 ① You cannot restore after clicking <Delete>.

#### About the default IP filter packets

- No. 59-64: These filtering conditions prevent the Windows applications from the remote access and leaking information caused by the File Sharing.  
 ① The \* mark matches all values.

## Simple DNS screen

Router Settings > Simple DNS

### Simple DNS Server Setting

The settings to use the RoIP Gateway as a simple DNS server.

Simple DNS Server Settings		
* A DNS Proxy must be enabled in <a href="#">the DHCP Server</a> settings to use this function.		
IP Address	DNS Host Name	
<input type="text"/>	<input type="text"/>	<input type="button" value="Add"/>

Enter the combination of the terminal host name and the IP address corresponding to the host and click <Add>. When the combination is registered, the RoIP Gateway can respond to both DNS forward lookup and DNS reverse lookup.

- ① Up to 32 combinations can be registered.
- ① This setting is effective when using the DNS proxy response function of the RoIP Gateway.
- ① We recommend that you use a static DHCP server to fix the combination of the MAC address and the IP address when registering the local IP address and its host name.
- ① If you register "Host Name.Domain Name" as the host name, the RoIP Gateway can respond to the request, even if only the host name matches.

Router Settings > Simple DNS

### List of Simple DNS Server Settings

Lists the simple DNS Server entries.  
Click <Delete> to delete the entry.

List of Simple DNS Server Settings		
IP Address	DNS Host Name	
192.168.0.4	192.168.0.4	<input type="button" value="Delete"/>

## VPN screen

Router Settings > VPN

### ■ IPsec Settings

Set the virtual private network (VPN) connection using the IPsec protocol.

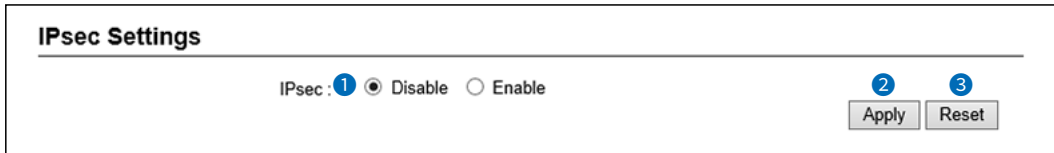

- 1 IPsec** ..... Set the IPsec function. (Default: Disable)  
When “Enable” is set, a VPN connection using the IPsec tunnel can be used.
- 2 <Apply>** ..... Click to apply the entries.
- 3 <Reset>** ..... Click to reset the settings.  
① You cannot reset after clicking <Apply>.

## ■ IPsec Tunnel Settings

Set the virtual private network (VPN) connection using the IPsec tunnel.

- 1 Tunnel Interface** ..... Specifying the interface to register the IPsec tunnel.  
Range: vti0 ~ vti31
  
- 2 Tunnel** ..... Select "Enable" to use the IPsec tunnel to register. (Default: Enable)  
Select "Disable" when it is registered but not used.
  
- 3 Tunnel Name** ..... Enter the name to identify the IPsec tunnel of up to 31 characters.
  
- 4 Interface** ..... Select the interface to connect with Remote Address. (Default: eth0)

  - **eth0**  
Select this interface when "Static IP" or "DHCP client" is set in the "Connection Type" setting (Router Settings > WAN > Connection Type).
  - **ppp0(WAN01) ~ ppp7(WAN08)**  
Select this interface when "PPPoE(WAN01 ~ WAN08)" is set in the "Connection Type" setting (Router Settings > WAN > Connection Type).  
① "WAN01 ~ WAN08" are the nicknames.
  
- 5 Authentication Key (Pre-Shared Key)** ..... To authenticate the VPN Remote peer, enter the same character strings as the connected device of up to 128 alphanumeric characters.
  
- 6 Remote Address** ..... Enter the IP address or the host name of the VPN connection destination. When the IP address or the host name is entered, the RoIP Gateway initiates a VPN connection to the connected device.  
① If this item is not set, the RoIP Gateway only works as a responder that waits for a connection from other devices.



## VPN screen

### Router Settings > VPN

#### ■ IPsec Tunnel Settings

### IPsec Tunnel Settings

Tunnel Interface: ① vti1 ▼

Tunnel: ②  Disable  Enable

Tunnel Name: ③ \_\_\_\_\_

Interface: ④ eth0 ▼

Authentication Key (Pre-Shared Key): ⑤ \_\_\_\_\_

Remote Address: ⑥ \_\_\_\_\_

Remote ID: ⑦ IP Address ▼ \_\_\_\_\_

Local ID: ⑧ IP Address ▼ \_\_\_\_\_

Apply
Reset

#### ⑦ Remote ID .....

Set the ID to identify the connected device.  
 Select the IP type from "IP Address," "KEYID," "FQDN," or "USER-FQDN."  
 (Default: IP Address)

IP Address: IP address format  
 KEYID: Up to 256 alphanumeric characters  
 FQDN: Domain name up to 253 characters  
 USER-FQDN: Mail address format up to 254 characters  
 Example: user@xxxx.yyyy.zzzz



1. Up to 64 characters
2. Up to 63 characters for each part

#### ⑧ Local ID .....

Set the ID to identify the local device.  
 Select the IP type from "IP Address," "KEYID," "FQDN," or "USER-FQDN."  
 (Default: IP Address)

- **IP Address:** IP address format
  - **KEYID:** Up to 256 alphanumeric characters
  - **FQDN:** Domain name up to 253 characters
  - **USER-FQDN:** Mail address format up to 254 characters
- Example: user@xxxx.yyyy.zzzz

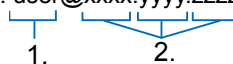

1. Up to 64 characters
2. Up to 63 characters for each part

#### ⑨ <Apply> .....

Click to apply the entries.

#### ⑩ <Reset> .....

Click to reset the settings.  
 ⓘ You cannot reset after clicking <Apply>.

## List of IPsec Tunnel Settings

Lists the connections settings.

1 Tunnel Interface	2 Interface	3 Status	4 Remote Address	5 Remote ID	6 Local ID	7	8
vti0 (Sales)	ppp0 (WAN01)	IPsec is Disabled	.....	IP Address .....	IP Address .....	Edit	Delete

- 1 Tunnel Interface** ..... The interface name (tunnel name) is displayed.
- 2 Interface** ..... The interface name of the tunnel source is displayed.
- 3 Status** .....

  - **Connected:** Connected.
  - **Waiting:** Connection ready.
  - **Connecting:** Connection in progress.
  - **Disable:** IPsec is enable but Tunnel Setting is disable.
  - **IPsec is Disabled:** The RoIP Gateway's IPsec function is disabled.
- 4 Remote Address** .....

The IP address set as the connection destination or the host name is displayed.  
 "-" is displayed when this item is not set in a Responder.  
 The destination IP address is displayed while connecting.  
 ① When a VPN connection is made while the Responder function is ON, the Remote Address is displayed in parentheses, as in (172.16.\*\*\*.\*\*\*).
- 5 Remote ID** ..... The peer ID is displayed.
- 6 Local ID** ..... The local ID is displayed.
- 7 <Edit>** ..... Click to edit the entry.
- 8 <Delete>** .....

  - Click to delete the entry.
  - ① You cannot restore after clicking <Delete>.

---

Bridge Connection screen .....	5-2
■ Bridge Connection .....	5-2
■ Bridge Connection Entry List (For Combination) .....	5-11
■ Bridge Connection Entry List (For Custom Bridge Connection) .....	5-12
■ AMBE+2 Vocoder Assignment .....	5-13
SelCall in Bridge Connection screen.....	5-15
■ Save or Write the Rule Settings for SelCall in Bridge Connection .....	5-15
■ Rule Settings for SelCall in Bridge Connection .....	5-16
■ List of Rule Settings for SelCall in Bridge Connection .....	5-17

## Bridge Connection screen

Bridge Connection Settings > Bridge Connection

### Bridge Connection

Sets the transceiver port bridge connection combination.

- ① The transceiver port assigned as a bridge connection source or a destination is no longer usable as a call destination.
- ① The EXT 1 and MIC ports are not usable at the same time. The EXT 1 port is disabled while a microphone is connected to the MIC port on the front panel.

#### Unicast mode

**Bridge Connection**

---

**Combination**

Bridge Connection Source : ① Digital Transceiver1 (D-TRX1) ▼

Bridge Connection Destination : ② Custom Bridge Connection ▼

Transmission Mode : ③ Unicast ▼

SelCall in Bridge Connection : ④  Disable  Enable

Destination Address : ⑤ \_\_\_\_\_

Destination Port Number : ⑥ 23000

Source Port Number : ⑦ 23000

⑨ Apply
⑩ Reset

- ① The above example shows when the Bridge Connection Destination (②) is set to “Custom Bridge Connection.”

#### Multicast mode

Transmission Mode : ③ Multicast ▼

---

Source Port Number : ⑧ \_\_\_\_\_

Multicast TTL : ⑧ 1

⑨ Apply
⑩ Reset

**Bridge Connection**

---

**Combination**

Bridge Connection Source : ① Digital Transceiver1 (D-TRX1) ▼

Bridge Connection Destination : ② Digital Transceiver2 (D-TRX2) ▼

⑨ Apply
⑩ Reset

- ① The above example shows when the Bridge Connection Destination (②) is set to “Digital Transceiver 2 (D-TRX2).”

- ① **Bridge Connection Source...** Select the port for the bridge connection.
- ② **Bridge connection Destination** Select the destination port for the bridge connection.
  - ① Only the ports that can be connected to the source port (①) are listed in this setting.

**NOTE:** When you set a combination of a Digital Transceiver and an analog transceiver (EXT(I/O) Port,) enter [AMBE+2 Vocoder Assignment] settings below on the same screen.

## Bridge Connection screen

### Bridge Connection Settings > Bridge Connection

#### ■ Bridge Connection

##### Unicast mode

**Bridge Connection**

Combination

Bridge Connection Source : ① Digital Transceiver1 (D-TRX1) ▼

Bridge Connection Destination : ② Custom Bridge Connection ▼

Transmission Mode : ③ Unicast ▼

SelCall in Bridge Connection : ④  Disable  Enable

Destination Address : ⑤

Destination Port Number : ⑥ 23000

Source Port Number : ⑦ 23000

⑨ Apply ⑩ Reset

① The above example shows when the Bridge Connection Destination (②) is set to “Custom Bridge Connection.”

##### Multicast mode

**Bridge Connection**

Combination

Bridge Connection Source : ① Digital Transceiver1 (D-TRX1) ▼

Bridge Connection Destination : ② Digital Transceiver2 (D-TRX2) ▼

Transmission Mode : ③ Multicast ▼

Source Port Number : ④

Destination Port Number : ⑤

Multicast TTL : ⑧ 1

⑨ Apply ⑩ Reset

① The above example shows when the Bridge Connection Destination (②) is set to “Digital Transceiver 2 (D-TRX2).”

③ **Transmission Mode** ..... Set the transmission mode for Bridge Connection with the RoIP Gateway by either Unicast or Multicast.

④ **SelCall in Bridge Connection** Set whether or not you can make an Individual call to a device that is connected to the same network as this RoIP Gateway. (Default: Disable)

① If this setting is enabled, The RoIP Gateway connects to the destination device according to the List of Rule Settings for SelCall in Bridge Connection.

(Bridge Connection Settings > SelCall in Bridge Connection > List of Rule Settings for SelCall in Bridge Connection)

① This setting is displayed when the combination of Digital Transceiver (D-TRX1 ~ 4) and the Custom Bridge Connection are set.

## Bridge Connection screen

### Bridge Connection Settings > Bridge Connection

#### ■ Bridge Connection

##### Unicast mode

**Bridge Connection**

---

Combination

Bridge Connection Source : ① Digital Transceiver1 (D-TRX1) ▼

Bridge Connection Destination : ② Custom Bridge Connection ▼

Transmission Mode : ③ Unicast ▼

SelCall in Bridge Connection : ④  Disable  Enable

Destination Address : ⑤ \_\_\_\_\_

Destination Port Number : ⑥ 23000

Source Port Number : ⑦ 23000

⑨  ⑩

① The above example shows when the Bridge Connection Destination (②) is set to “Custom Bridge Connection.”

##### Multicast mode

**Bridge Connection**

---

Combination

Bridge Connection Source : ① Digital Transceiver1 (D-TRX1) ▼

Bridge Connection Destination : ② Digital Transceiver2 (D-TRX2) ▼

Transmission Mode : ③ Multicast ▼

Source Port Number : \_\_\_\_\_

Multicast TTL : ⑧ 1

⑨  ⑩

① The above example shows when the Bridge Connection Destination (②) is set to “Digital Transceiver 2 (D-TRX2).”

#### ⑤ Destination Address .....

Set the IP address as follows.

① When “Enable” is selected in the SelCall in Bridge Connection (④), this item is not displayed.

- **When the Transmission mode is “Unicast”:**  
Enter a Destination Address, or its domain name of up to 63 characters.

- **When the Transmission mode is “Multicast”:**  
Enter the same multicast address as the setting in the Bridge Connection Destination.  
The settable range: 244.0.0.0 ~ 239.255.255.255

(Default: 239.255.255.1)

## Bridge Connection screen

### Bridge Connection Settings > Bridge Connection

#### ■ Bridge Connection

##### Unicast mode

**Bridge Connection**

---

Combination

Bridge Connection Source : ① Digital Transceiver1 (D-TRX1) ▼

Bridge Connection Destination : ② Custom Bridge Connection ▼

Transmission Mode : ③ Unicast ▼

SelCall in Bridge Connection : ④  Disable  Enable

Destination Address : ⑤ \_\_\_\_\_

Destination Port Number : ⑥ 23000

Source Port Number : ⑦ 23000

⑨ Apply ⑩ Reset

① The above example shows when the Bridge Connection Destination (②) is set to “Custom Bridge Connection.”

##### Multicast mode

**Bridge Connection**

---

Combination

Bridge Connection Source : ① Digital Transceiver1 (D-TRX1) ▼

Bridge Connection Destination : ② Custom Bridge Connection ▼

Transmission Mode : ③ Multicast ▼

Source Port Number : \_\_\_\_\_

Multicast TTL : ⑧ 1

⑨ Apply ⑩ Reset

#### ⑥ Destination Port Number ...

Set the same port number as the Source Port Number (⑦).

- Range: An even number from 1024 to 65534.

① Do not duplicate other connection port settings.

① When “Enable” is selected in the SelCall in Bridge Connection (④), this item is not displayed.

#### ○ The Default port settings in the Unicast mode

Options	Default	Options	Default
Digital Transceiver 1 (D-TRX1)	23000	EXT Output 4(EXT4)	23114
Digital Transceiver 2 (D-TRX2)	23002	Emergency Notification	23116
Digital Transceiver 3 (D-TRX3)	23004	Microphone (MIC)	23150
Digital Transceiver 4 (D-TRX4)	23006	RoIP Gateway1	24300
EXT Input 1 (EXT1) / EXT I/O 1 (EXT1)	23100	RoIP Gateway2	24302
EXT Output 1 (EXT1)	23102	RoIP Gateway3	24304
EXT Input 2 (EXT2) / EXT I/O 2 (EXT2)	23104	RoIP Gateway4	24306
EXT Output 2 (EXT2)	23106	RoIP Gateway5	24308
EXT Input 3 (EXT3) / EXT I/O 3 (EXT3)	23108	RoIP Gateway6	24310
EXT Output 3 (EXT3)	23110	RoIP Gateway7	24312
EXT Input 4 (EXT4) / EXT I/O 4 (EXT4)	23112	RoIP Gateway8	24314

# 5 BRIDGE CONNECTION SETTINGS

## Bridge Connection screen

### Bridge Connection Settings > Bridge Connection

#### ■ Bridge Connection

##### Unicast mode

**Bridge Connection**

---

Combination

Bridge Connection Source : ① Digital Transceiver1 (D-TRX1) ▼

Bridge Connection Destination : ② Custom Bridge Connection ▼

Transmission Mode : ③ Unicast ▼

SelCall in Bridge Connection : ④  Disable  Enable

Destination Address : ⑤ \_\_\_\_\_

Destination Port Number : ⑥ 23000

Source Port Number : ⑦ 23000

⑨  ⑩

① The above example shows when the Bridge Connection Destination (②) is set to “Custom Bridge Connection.”

##### Multicast mode

**Bridge Connection**

---

Combination

Bridge Connection Source : ① Digital Transceiver1 (D-TRX1) ▼

Bridge Connection Destination : ② Custom Bridge Connection ▼

Transmission Mode : ③ Multicast ▼

Source Port Number : \_\_\_\_\_

Multicast TTL : ⑧ 1

⑨  ⑩

#### ⑥ Destination Port Number (Continued)

##### ○ The Default port settings in the Multicast mode

Options	Default	Options	Default
Digital Transceiver 1 (D-TRX1)	22510	EXT Output 4(EXT4)	22510
Digital Transceiver 2 (D-TRX2)	22510	Emergency Notification	23116
Digital Transceiver 3 (D-TRX3)	22510	Microphone (MIC)	22510
Digital Transceiver 4 (D-TRX4)	22510	RoIP Gateway1	22530
EXT Input 1 (EXT1) / EXT I/O 1 (EXT1)	22510	RoIP Gateway2	22530
EXT Output 1 (EXT1)	22510	RoIP Gateway3	22530
EXT Input 2 (EXT2) / EXT I/O 2 (EXT2)	22510	RoIP Gateway4	22530
EXT Output 2 (EXT2)	22510	RoIP Gateway5	22530
EXT Input 3 (EXT3) / EXT I/O 3 (EXT3)	22510	RoIP Gateway6	22530
EXT Output 3 (EXT3)	22510	RoIP Gateway7	22530
EXT Input 4 (EXT4) / EXT I/O 4 (EXT4)	22510	RoIP Gateway8	22530



## Bridge Connection screen

### Bridge Connection Settings > Bridge Connection

#### ■ Bridge Connection

##### Unicast mode

**Bridge Connection**

---

Combination

Bridge Connection Source : ① Digital Transceiver1 (D-TRX1) ▼

Bridge Connection Destination : ② Custom Bridge Connection ▼

Transmission Mode : ③ Unicast ▼

SelCall in Bridge Connection : ④  Disable  Enable

Destination Address : ⑤ \_\_\_\_\_

Destination Port Number : ⑥ 23000

Source Port Number : ⑦ 23000

⑨  ⑩

① The above example shows when the Bridge Connection Destination (②) is set to “Custom Bridge Connection.”

##### Multicast mode

**Bridge Connection**

---

Combination

Bridge Connection Source : ① Digital Transceiver1 (D-TRX1) ▼

Bridge Connection Destination : ② Custom Bridge Connection ▼

Transmission Mode : ③ Multicast ▼

Source Port Number : \_\_\_\_\_

Multicast TTL : ⑧ 1

⑨  ⑩

#### ⑦ Source Port Number .....

Set the port number to receive the audio signal.

- Range: An even number from 1024 to 65534.

- ① This setting is also used to the source port number to transmit the audio signal.
- ① For communication, the set port number (RTP) and the set port number +1 (RTCP) are used.
- ① Do not duplicate other connection port settings, when using in the Unicast mode.
- ① The default settings differ, depending on the EXT I/O Port Mode setting. (Connection Port Settings > EXT I/O (EXT) > EXT I/O Port Mode)

#### ○ The Default port settings in the Unicast mode

Options	Default	Options	Default
Digital Transceiver 1 (D-TRX1)	23000	EXT Output 4(EXT4)	23114
Digital Transceiver 2 (D-TRX2)	23002	Emergency Notification	23116
Digital Transceiver 3 (D-TRX3)	23004	Microphone (MIC)	23150
Digital Transceiver 4 (D-TRX4)	23006	RoIP Gateway1	24300
EXT Input 1 (EXT1) / EXT I/O 1 (EXT1)	23100	RoIP Gateway2	24302
EXT Output 1 (EXT1)	23102	RoIP Gateway3	24304
EXT Input 2 (EXT2) / EXT I/O 2 (EXT2)	23104	RoIP Gateway4	24306
EXT Output 2 (EXT2)	23106	RoIP Gateway5	24308
EXT Input 3 (EXT3) / EXT I/O 3 (EXT3)	23108	RoIP Gateway6	24310
EXT Output 3 (EXT3)	23110	RoIP Gateway7	24312
EXT Input 4 (EXT4) / EXT I/O 4 (EXT4)	23112	RoIP Gateway8	24314

## 5 BRIDGE CONNECTION SETTINGS

### Bridge Connection screen

#### Bridge Connection Settings > Bridge Connection

#### ■ Bridge Connection

##### Unicast mode

**Bridge Connection**

---

**Combination**

Bridge Connection Source : ① Digital Transceiver1 (D-TRX1) ▼

Bridge Connection Destination : ② Custom Bridge Connection ▼

Transmission Mode : ③ Unicast ▼

SelCall in Bridge Connection : ④  Disable  Enable

Destination Address : ⑤ \_\_\_\_\_

Destination Port Number : ⑥ 23000

Source Port Number : ⑦ 23000

⑨  ⑩

① The above example shows when the Bridge Connection Destination (②) is set to “Custom Bridge Connection.”

##### Multicast mode

**Bridge Connection**

---

**Combination**

Bridge Connection Source : ① Digital Transceiver1 (D-TRX1) ▼

Bridge Connection Destination : ② Custom Bridge Connection ▼

Transmission Mode : ③ Multicast ▼

Source Port Number : \_\_\_\_\_

Multicast TTL : ⑧ 1

⑨  ⑩

#### ⑦ Source Port Number (Continued)

##### ○ The Default port settings in the Multicast mode

Options	Default	Options	Default
Digital Transceiver 1 (D-TRX1)	22510	EXT Output 4(EXT4)	22510
Digital Transceiver 2 (D-TRX2)	22510	Emergency Notification	22510
Digital Transceiver 3 (D-TRX3)	22510	Microphone (MIC)	22510
Digital Transceiver 4 (D-TRX4)	22510	RoIP Gateway1	22530
EXT Input 1 (EXT1) / EXT I/O 1 (EXT1)	22510	RoIP Gateway2	22530
EXT Output 1 (EXT1)	22510	RoIP Gateway3	22530
EXT Input 2 (EXT2) / EXT I/O 2 (EXT2)	22510	RoIP Gateway4	22530
EXT Output 2 (EXT2)	22510	RoIP Gateway5	22530
EXT Input 3 (EXT3) / EXT I/O 3 (EXT3)	22510	RoIP Gateway6	22530
EXT Output 3 (EXT3)	22510	RoIP Gateway7	22530
EXT Input 4 (EXT4) / EXT I/O 4 (EXT4)	22510	RoIP Gateway8	22530

## Bridge Connection screen

### Bridge Connection Settings > Bridge Connection

#### ■ Bridge Connection

##### Unicast mode

**Bridge Connection**

---

**Combination**

Bridge Connection Source : ① Digital Transceiver1 (D-TRX1) ▼

Bridge Connection Destination : ② Custom Bridge Connection ▼

Transmission Mode : ③ Unicast ▼

SelCall in Bridge Connection : ④  Disable  Enable

Destination Address : ⑤ \_\_\_\_\_

Destination Port Number : ⑥ 23000

Source Port Number : ⑦ 23000

⑨  ⑩

① The above example shows when the Bridge Connection Destination (②) is set to “Custom Bridge Connection.”

##### Multicast mode

**Bridge Connection**

---

**Combination**

Bridge Connection Source : ① Digital Transceiver1 (D-TRX1) ▼

Bridge Connection Destination : ② Custom Bridge Connection ▼

Transmission Mode : ③ Multicast ▼

Source Port Number : \_\_\_\_\_

Multicast TTL : ⑧ 1

⑨  ⑩

#### ⑧ Multicast TTL .....

Displayed only when the Transmission Mode (③) is set to “Multicast.”  
 As the expiration date of the voice packet, set the TTL (Time To Live) until the voice packet reaches the communication destination.  
 The TTL value decreases every time it passes through a router, the voice packets transmission expires when the TTL value reaches zero.  
 Therefore you can prevent a packet transmission loop. (Default: 1)  
 • Range: 1 ~255

Bridge Connection screen

Bridge Connection Settings > Bridge Connection

■ Bridge Connection

**Unicast mode**

① The above example shows when the Bridge Connection Destination (2) is set to “Custom Bridge Connection.”

**Multicast mode**

9 <Apply> .....

Click to apply the entries.

① When you select other than Custom Bridge Connection for a combination, the connection is activated as soon as you click <Apply>. The entries are displayed in [Bridge Connection Entry List (For Combination)] screen.

① When “Custom Bridge Connection” is selected in the Bridge Connection Destination, the entries are displayed in [Bridge Connection Entry List (For Custom Bridge Connection)] screen.

Click <Activate> in the list to activate the bridge connection.

10 <Reset> .....

Click to reset the settings.

① You cannot restore after clicking <Apply>.

Bridge Connection screen

Bridge Connection Settings > Bridge Connection

### ■ Bridge Connection Entry List (For Combination)

Lists the combination entries of the bridge connection. See the “ Bridge Connection Entry List (For Custom Bridge Connection)” below when the Bridge Connection Destination is set to “Custom Bridge Connection.”

Bridge Connection Entry List (For Combination)		
Bridge Connection Source	Bridge Connection Destination	
Digital Transceiver1 (D-TRX1)	EXT I/O1 (EXT1)	<b>1</b> Delete
		<b>2</b> Delete All

**1** <Delete> .....

Click to delete the entry.  
① You cannot restore after clicking <Delete>.

**2** <Delete All> .....

Click to delete all the entries.  
① You cannot restore after clicking <Delete All>.

Bridge Connection screen

Bridge Connection Settings > Bridge Connection

### ■ Bridge Connection Entry List (For Custom Bridge Connection)

Lists the combination entries of the bridge connection when the Bridge Connection Destination is set to “Custom Bridge Connection.”

Bridge Connection Entry List (For Custom Bridge Connection)						Refresh		
Bridge Connection Source	Transmission Mode	Destination Address	Port Number		Connection Status			
			Destination	Source		Activate	Edit	Delete
Digital Transceiver2 (D-TRX2)	Unicast	192.168.0.200	23002	23002	Inactive	Activate	Edit	Delete
						Delete All		

- 1 <Refresh>** ..... Click to reload the list.
- 2 <Activate>** ..... Click to connect the set devices.  
 After they are successfully connected, the button changes to “Deactivate.”  
 ⓘ When this button is grayed out, you also need to enter the “AMBE+2 Vocoder Assignment” settings.
- 3 <Edit>** ..... Click to edit the entry.  
 ⓘ You can edit the settings in “Bridge Connection” on the above screen.  
 ⓘ Disconnect the connection before editing an entry.
- 4 <Delete>** ..... Click to delete the entry.  
 ⓘ You cannot restore after clicking <Delete>.
- 5 <Delete All>** ..... Click to delete all the settings in the list.  
 ⓘ You cannot restore after clicking <Delete All>.

## Bridge Connection screen

Bridge Connection Settings > Bridge Connection

### ■ AMBE+2 Vocoder Assignment

Assigns the Voice Protocol and the AMBE+2 Vocoder to each port.

Port Name <sup>1</sup>	Route Setting Screen <sup>2</sup>	Voice Protocol <sup>3</sup> (For Custom Bridge Connection)	Voice Protocol <sup>4</sup> (For Port Connection)	AMBE+2 Vocoder Assignment <sup>5</sup>
Digital Transceiver1 (D-TRX1)	Bridge Connection		-	Not Assigned ▼
Digital Transceiver2 (D-TRX2)	Bridge Connection	G.711u ▼	-	Not Assigned ▼
Digital Transceiver3 (D-TRX3)	Destination Settings		-	Internal ▼
Digital Transceiver4 (D-TRX4)	Destination Settings		-	Not Assigned ▼
EXT I/O1 (EXT1)	Bridge Connection		-	
EXT I/O2 (EXT2)	Destination Settings		-	
EXT I/O3 (EXT3)	Destination Settings		-	
EXT Input4 (EXT4)	Destination Settings		-	
EXT Output4 (EXT4)	Destination Settings		-	
Emergency Notification	Destination Settings		-	
Microphone (MIC)	Destination Settings		-	
RolP Gateway1	Destination Settings		G.711u ▼	
RolP Gateway2	Destination Settings		G.711u ▼	
RolP Gateway3	Destination Settings		G.711u ▼	
RolP Gateway4	Destination Settings		G.711u ▼	
RolP Gateway5	Destination Settings		G.711u ▼	
RolP Gateway6	Destination Settings		G.711u ▼	
RolP Gateway7	Destination Settings		G.711u ▼	
RolP Gateway8	Destination Settings		G.711u ▼	
Converter Bridge1	-	-	G.711u ▼	
Converter Bridge2	-	-	G.711u ▼	

**1 Port Name** .....

Lists the transceiver port of the RolP gateway. Click to open to the Connection Port Settings screen of the port.

① The Converter Bridge setting screen (PBX extension > Converter Bridge) is displayed when a converter bridge's port name is clicked.

**2 Route Setting Screen** .....

The screen setting the route of the destination is displayed. When the entry is set as a combination by the bridge connection, "Bridge Connection" is displayed. Otherwise, "Destination Settings" is displayed.

① Click the "Destination Settings" link to open the Destination Settings screen.

**3 Voice Protocol (For Custom Bridge Connection)** .....

Displayed only when the Bridge Connection Destination (see above on this setting screen) is set to "Custom Bridge Connection." Set the voice protocol for the custom bridge connection to "G.711u," "Bridge Protocol," or "AMBE+2."

## Bridge Connection screen

### Bridge Connection Settings > Bridge Connection

#### ■ AMBE+2 Vocoder Assignment

Port Name	Route Setting Screen	Voice Protocol (For Custom Bridge Connection)	Voice Protocol (For Port Connection)	AMBE+2 Vocoder Assignment
Digital Transceiver1 (D-TRX1)	Bridge Connection	-	-	Not Assigned
Converter Bridge19	-	-	G.711u	
Converter Bridge20	-	-	G.711u	

#### ④ Voice Protocol (For Port Connection) .....

Set the voice protocol for the port connection to “G.711u,” “Protocol for Transceiver and SIP Phone Connection,” “Bridge Protocol,” or “AMBE+2.”

(Default for RoIP Gateway 1 ~ 8: G.711u,  
for Converter Bridge 1 ~ 20: G.711u)

- ① “Protocol for Transceiver and SIP Phone Connection” can be selected only with the Converter Bridge 1 ~ 20.
- ① If you connect to the IP1000C, set this item to “Protocol for Transceiver and SIP Phone Connection.”
- ① If you connect to the VE-PG4, set this item to “Bridge Protocol.”

#### ⑤ AMBE+2 Vocoder Assignment .....

Settable only when the Voice Protocol (④) is set to AMBE+2.  
Select an AMBE+2 Vocoder from “Not Assigned,” “Internal,” or “CT-24.”  
(Default for Digital Transceiver 1 ~ 4 (D-TRX1 ~ 4) : Internal)

- **Internal:** Assignable up to 4 ports.
- **CT-24:** Assignable up to 2 ports. (The optional CT-24 is required.)

- ① The AMBE+2 Vocoder for the Digital Transceiver 1 ~ 4 (D-TRX1 ~ 4) is fixed to the internal vocoder.
- ① When the settings of Bridge Connection Source and Bridge Connection Destination are set as the digital transceiver in [Bridge Connection] setting (Bridge Connection Settings > Bridge Connection > Bridge Connection), this item is not displayed.

#### ⑥ <Apply> .....

Click to apply the entries.

#### ⑦ <Reset> .....

Click to reset the settings.

- ① You cannot restore after clicking <Apply>.



## SelCall in Bridge Connection screen

Bridge Connection Settings > SelCall in Bridge Connection

### ■ Save or Write the Rule Settings for SelCall in Bridge Connection

You can save or load the settings in “Rule Settings for SelCall in Bridge Connection” to or from a CSV format file.

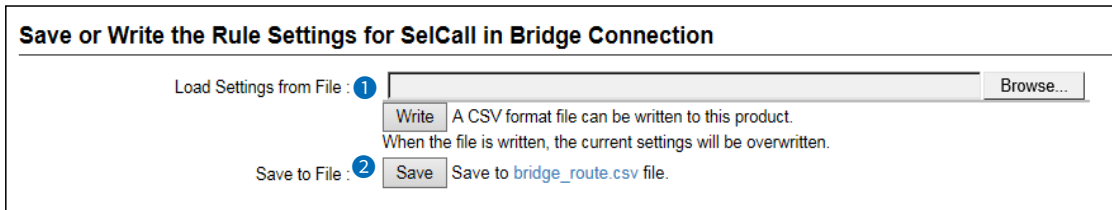

**1 Load Setting from File .....**

You can load the saved SelCall rule settings from a CSV format file. Click <Browse> and select the setting file (bridge\_route.csv) from the displayed list, and then click <Open>. Confirm the correct file is selected, and then click <Write> to load the settings from the selected file.  
① Note that the previous settings are deleted when the setting file is loaded.

**2 Save to File .....**

Saves the settings in the “Rule Settings for SelCall in Bridge Connection settings” to a CSV format file. Click <Save> and select a folder to save the file into. You can edit the saved file on a spreadsheet.

SelCall in Bridge Connection screen

Bridge Connection Settings > SelCall in Bridge Connection

### ■ Rule Settings for SelCall in Bridge Connection

Sets the rules to make a individual call from a Digital transceiver that is connected to the RoIP Gateway, through a Bridge Connection.

Rule Settings for SelCall in Bridge Connection							
Index ①	Name ②	Call Type ③	Prefix ID ④	Destination ID ⑤	Destination SelCall in Bridge Connection		⑧
					Address ⑥	Port Number ⑦	
3 ▼		Individual ▼					Add

- ① **Index** ..... The index assigned for entry.  
Setting range: 1 ~ 1000
  - ② **Name** ..... Enter a name of up to 31 characters.
  - ③ **Call Type** ..... Select the type of call.
    - **Individual** : Call only a specified radio.
    - **Group** : Call all transceivers that belong to the specified group.
    - **All** : Call all transceivers.
  - ④ **Prefix ID** ..... Enter the prefix ID of the SelCall destination.  
ID range: (Depending on the system mode)
  - ⑤ **Destination ID** ..... Enter the ID of the SelCall destination.  
ID range: (Depending on the system mode)
- Destination SelCall in Bridge Connection**
- ⑥ **Address** ..... Enter the RoIP Gateway's IP address which is connected to the transceiver that will communicate with the SelCall destination.
  - ⑦ **Port Number** ..... Enter the RoIP Gateway's port number which is connected to the transceiver that will communicate with the SelCall destination.
  - ⑧ **<Add>** ..... Click to add a SelCall rule to the List of Rule Settings for SelCall in Bridge Connection.

SeiCall in Bridge Connection screen

Bridge Connection Settings > SeiCall in Bridge Connection

■ List of Rule Settings for SeiCall in Bridge Connection

Index	Name	Call Type	Prefix ID	Destination ID	Destination SeiCall in Bridge Connection		1	2
					Address	Port Number		
1	Sales	Individual	11	101	192.168.1.1	12122	Edit	Delete
2	Planning	Individual	21	201	192.168.2.1	12122	Edit	Delete

3  
Delete All

1 <Edit> .....

Click to edit the entry.

① The registered contents are displayed on the Rule Settings for SeiCall in Bridge Connection screen.

2 <Delete> .....

Click to delete the entry.

① You cannot restore after clicking <Delete>.

3 <Delete All> .....

Click to delete all the settings.

① You cannot restore after clicking <Delete All>.

---

RoIP Settings screen .....	6-3
■ Additional Controller Settings .....	6-3
■ Advanced Settings .....	6-4
Tenant (Fleet) Settings screen .....	6-7
■ Tenant (Fleet) .....	6-7
RoIP Server screen .....	6-8
■ Call Type Priority .....	6-8
Additional Controller Link screen .....	6-9
■ Link Setting .....	6-9
■ Linked Controller List .....	6-10
Area Call screen .....	6-11
■ Area Setting .....	6-11
■ Access Point Search .....	6-12
■ Area Entry List .....	6-14
Transceiver Management screen .....	6-15
■ Transceiver Management .....	6-15
Transceiver Registration screen .....	6-17
■ Transceiver Settings .....	6-17
■ Transceiver Setting Entry List .....	6-19
■ TRX Batch Setting .....	6-20
Transceiver Settings screen .....	6-21
■ Transceiver Settings .....	6-21
■ Copy Transceiver Settings .....	6-53
■ Transceiver Setting List .....	6-53
Wireless LAN screen .....	6-54
■ Wireless LAN .....	6-54
■ List of Wireless LAN Entries .....	6-61
ID List screen .....	6-62
■ ID List Common Settings .....	6-62
■ ID List Advanced Settings .....	6-62
■ Save or Write the ID List Setting .....	6-63
■ ID List .....	6-65
■ ID List Entries .....	6-67

Messages screen .....	6-68
■ Message Group .....	6-68
■ Message Group Detail .....	6-68
■ Save or Write the Message Setting .....	6-69
■ Message List .....	6-71
Status screen .....	6-72
■ Status Settings.....	6-72
Profile screen .....	6-73
■ Profile List.....	6-73
■ Profile .....	6-74
■ Profile Batch Setting .....	6-83

## RoIP Settings screen

Transceiver Controller > RoIP Settings

### ■ Additional Controller Settings

Configure the Additional Controller Settings.

You can communicate with the IP100Hs and the IP100FS that are registered to additional controllers.

Additional Controller Settings	
Controller Mode :	① <input checked="" type="radio"/> Sub <input type="radio"/> Master
Service Port Number :	② 32000

- ① **Controller Mode** ..... Select "Master" for one Master Controller. Select "Sub" for the other Controllers (up to 10 Sub Controllers can be set up). (Default: Sub)  
When several Controllers are linked, and use All call or Group call between the controllers, set a controller as shown below.
- **Sub:** One Master Controller can be set up.
  - **Master:** Up to 10 Sub Controllers can be set up.
- ② **Service Port Number** ..... Enter the port number for receiving audio signals. (Default: 32000)  
• Range: "1024" ~ "65534" (only even numbers)  
The port number (RTP) and the port number +1 (RTCP) are used for communication.
- ① This number is also used for the caller port number.
  - ① Do not set a port number that has already been used by another connection setting.

RoIP Settings screen

Transceiver Controller > RoIP Settings

### Advanced Settings

Set the V/RoIP details.

The items on the RoIP Settings screen differ, depending on the TOS type setting.

The image shows three examples of the 'Advanced Settings' screen for different TOS (Type of Service) settings. Each example is enclosed in a box and has a callout on the left indicating the TOS type.

- Example 1: TOS Type: Not used**
  - Buffering Type: 1  Static  Dynamic
  - Receive Buffer Size: 2 40 (unit: milliseconds)
  - TOS Type: 3 Not Used
  - Buttons: 5 Apply, 6 Reset
- Example 2: TOS Type: TOS**
  - Buffering Type: 1  Static  Dynamic
  - Receive Buffer Size: 2 40 (unit: milliseconds)
  - TOS Type: 3 TOS
  - Media (RTP) Priority Level: 4 7
  - Media (RTP) Service Type: 0
  - Media (RTP) (HEX): E0
  - Buttons: 5 Apply, 6 Reset
- Example 3: TOS Type: Diffserv**
  - Buffering Type: 1  Static  Dynamic
  - Receive Buffer Size: 2 40 (unit: milliseconds)
  - TOS Type: 3 Diffserv
  - Media (RTP) DSCP: 4 56
  - Media (RTP) (HEX): E0
  - Buttons: 5 Apply, 6 Reset

(These are examples of when the [Buffering Type] (1) is set to "Static.")

- 1 Buffering Type** ..... Select the buffer type to control any interrupted sound. (Default: Dynamic)
  - **Static:** The buffer time is set in [Receive Buffer Size] (2).
  - **Dynamic:** The buffer time changes, depending on the audio fluctuation.
- 2 Receive Buffer Size** ..... Select the buffer time to keep the audio from breaking up. (Default: 40)
  - Range: "20" ~ "1000" (milliseconds)
  - A shorter value improves the delay, but it may frequently break the audio signal.
  - ① This item is displayed when [Buffering Type] (1) is set to "Static."

RoIP Settings screen

Transceiver Controller > RoIP Settings

■ Advanced Settings

The image shows three examples of the 'Advanced Settings' configuration screen for RoIP, all with 'Buffering Type' set to 'Static'. Each example has a callout on the left indicating the 'TOS Type' configuration.

- Example 1: TOS Type: Not used**
  - Buffering Type: 1  Static  Dynamic
  - Receive Buffer Size: 2 40 milliseconds
  - TOS Type: 3 Not Used
  - Media (RTP) Priority Level: 4 7
  - Media (RTP) Service Type: 0
  - Media (RTP) (HEX): E0
- Example 2: TOS Type: TOS**
  - Buffering Type: 1  Static  Dynamic
  - Receive Buffer Size: 2 40 milliseconds
  - TOS Type: 3 TOS
  - Media (RTP) Priority Level: 4 7
  - Media (RTP) Service Type: 0
  - Media (RTP) (HEX): E0
- Example 3: TOS Type: Diffserv**
  - Buffering Type: 1  Static  Dynamic
  - Receive Buffer Size: 2 40 milliseconds
  - TOS Type: 3 Diffserv
  - Media (RTP) DSCP: 4 56
  - Media (RTP) (HEX): E0

(These are examples of when the [Buffering Type] (1) is set to "Static.")

- 3 TOS type ..... Select the TOS (Type-Of Service) format. (Default: Not used)
- **Not used:** Does not use the TOS function.
  - **TOS:** Sends the VoIP packets to the TOS field (8 bits) in the IP header using the TOS format. Sets to between 1 (lowest) and 3 bits (Priority level) or 4 and 7 (highest) bits (Type of Service) based on the RFC1349. The 1 bit remaining is not used and is fixed as 0.
  - **Diffserv:** Sends the VoIP packets to the TOS field (8 bits) in the IP header using the Diffserv (Differentiated Service) format. Sets to between 1 and 6 bits (DSCP). The 2 bits remaining are not used and are fixed as 0.



RoIP Settings screen

Transceiver Controller > RoIP Settings

■ Advanced Settings

The image shows three examples of the 'Advanced Settings' screen for RoIP, each with a different TOS Type configuration. Callouts 1-6 highlight specific fields and buttons:

- Example 1: TOS Type: Not used**
  - 1: Buffering Type (Static selected)
  - 2: Receive Buffer Size (40)
  - 3: TOS Type (Not Used)
  - 5: Apply button
  - 6: Reset button
- Example 2: TOS Type: TOS**
  - 1: Buffering Type (Static selected)
  - 2: Receive Buffer Size (40)
  - 3: TOS Type (TOS)
  - 4: Media (RTP) Priority Level (7)
  - 5: Apply button
  - 6: Reset button
- Example 3: TOS Type: Diffserv**
  - 1: Buffering Type (Static selected)
  - 2: Receive Buffer Size (40)
  - 3: TOS Type (Diffserv)
  - 4: Media (RTP) DSCP (56)
  - 5: Apply button
  - 6: Reset button

(These are examples of when the [Buffering Type] (1) is set to "Static.")

- 4 **Media (RTP)** ..... Select the Priority level and Service type of the sent VoIP packets.
  - **Media (RTP) Priority Level**  
Set the TOS priority level to between 0 (lowest) and 7 (highest). (Default: 7)
  - **Media (RTP) Service Type**  
Set the TOS service type code to between 0 and 15. (Default: 0)
  - **Media (RTP) DSCP**  
Set the DSCP (Differentiated Services Code Point) code to between 0 and 63. (Default: 56)
- 5 **<Apply>** ..... Click to apply the entries.
- 6 **<Reset>** ..... Click to reset the settings.  
① You cannot reset after clicking <Apply>.

## Tenant (Fleet) Settings screen

Transceiver Controller > Tenant (Fleet) Settings

### Tenant (Fleet)

The tenant (fleet) divides the IP100Hs or IP100FSs that belong to the RoIP Gateway, for system management purposes. (Example: Security company/Management company)

- ① The terminals cannot communicate among different tenants (fleets).
- ① Select the tenant (fleet) number between 1 to 10.
- ① All IP100Hs and IP100FSs that belong to the RoIP Gateway are activated in one tenant (fleet).

**Tenant (Fleet)**

Tenant (Fleet) Number : ① 1

②
③ ✓

① **Tenant (Fleet) Number** ..... Select the tenant (fleet) number that is used. (Default: 1)

The tenant (fleet) number is displayed in the following menus.

- RoIP Server Settings
- Transceiver Settings
- Common Settings (Except Wireless LAN menu)
- Destination Settings

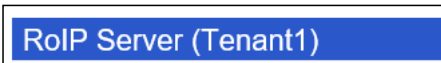

(This is an example when [Tenant (Fleet) Number] (①) is set to "1.")

② **<Apply>** ..... Click to apply the entries.

③ **<Reset>** ..... Click to reset the settings.  
① You cannot reset after clicking <Apply>.

## RoIP Server screen

Transceiver Controller > RoIP Server Settings > RoIP Server

### Call Type Priority

Select the priority level of the call types.

**Call Type Priority**

Call type Priority (High to low) : 1 Telephone - All - Individual - Group 2 3 ✓

Apply
Reset

- 1 **Call type Priority (High to low)**      Select the priority level of the call types.  
(Default: Telephone – All – Individual – Group)

① The setting value are shown below.

**Call Type Priority**

Call type Priority (High to low) :

Telephone - All - Individual - Group
Telephone - All - Group - Individual
Telephone - Individual - All - Group
Telephone - Individual - Group - All
Telephone - Group - All - Individual
Telephone - Group - Individual - All

2 **<Apply>** .....

Click to apply the entries.

3 **<Reset>** .....

Click to reset the settings.

① You cannot reset after clicking <Apply>.

## Additional Controller Link screen

Transceiver Controller > RoIP Server Settings > Additional Controller Link

### ■ Link Setting

This is a setting to link with IP1000Cs, VE-PG3s (Bridge mode), or VE-PG4s.

**Link Setting**

No. : ① 1 ▼

Name : ② \_\_\_\_\_

Destination Address : ③ \_\_\_\_\_

Destination Port Number : ④ 32000 ⑤ ⑥

- ① **No.** ..... Select a number between 1 and 100 to register the other transceiver controllers. (Default: 1)
- ② **Name** ..... Enter the group name of up to 31 characters.
- ③ **Destination Address** ..... Enter the destination device's IP address or domain name of up to 63 characters.
- ④ **Destination Port Number** ... Enter the destination controller's service port number in [Additional Controller Link]. (Default: 32000)  
 Range: "2" ~ "65534" (only even numbers)  
 ⓘ The set port number (RTP) and the port number +1 (RTCP) are used for communication.
- ⑤ **<Apply>** ..... Click to apply the entries.  
 ⓘ The entries are displayed in [Linked Controller List].
- ⑥ **<Reset>** ..... Click to reset the settings.  
 ⓘ You cannot reset after clicking <Apply>.

Additional Controller Link screen

Transceiver Controller > RoIP Server Settings > Additional Controller Link

### ■ Linked Controller List

Display a list of the destination addresses and destination port numbers registered to the RoIP Gateway.

Linked Controller List				
No.	Name	Destination Address	Destination Port Number	
1	Sales1	192.168.0.100	32000	<input type="button" value="Edit"/> <input type="button" value="Delete"/>
				<input type="button" value="Delete All"/>

- ① <Edit> ..... Click to edit the entry in [Link Setting].
- ② <Delete> ..... Click to delete the selected entry.  
① After clicking <Delete>, the entry cannot be recalled.
- ③ <Delete All> ..... Click to delete all the entries.  
① After clicking <Delete All>, the entries cannot be recalled.

## Area Call screen

Transceiver Controller > RoIP Server Settings > Area Call

### Area Setting

The Area call function limits communication with the devices in the specified area.

When an IP100H makes an All call or Group call using the Area call function, it calls other IP100Hs or IP100FSs in the same area.

① If you want to use the Area call from an IP100FS, specify the area by selecting the desired access points.

- ① **No.** ..... Select the number that is registered to the Area call. (Default: 1)  
① Up to 20 calls can be registered.
- ② **Name** ..... Enter the area name of up to 31 characters.
- ③ **BSSID** ..... Enter the 12 digit BSSID of the wireless access point in the area.  
When several access points are added, they are recognized as one area.  
① Up to 20 access points can be registered to the area.
- ④ **<Apply>** ..... Click to add the entries.  
① The entries are displayed in [Area Entry List].
- ⑤ **<Reset>** ..... Click to reset the settings.  
① You cannot reset after clicking <Apply>.

#### The IP100H makes All calls in the area

Example: The wireless access points “Sales” and “Accounts” are registered in the same area. The access point “Parts” is registered in a different area.

In that case, two IP100Hs in the same area receive the call, but the IP100H in the different area will not receive it.

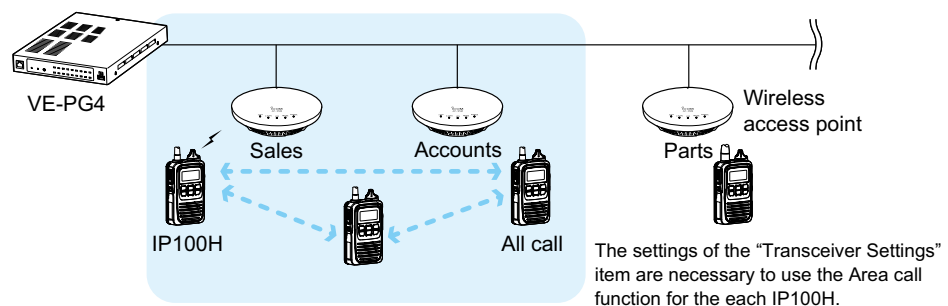

Area Call screen

Transceiver Controller > RoIP Server Settings > Area Call

### ■ Access Point Search

The RoIP Gateway can search for access points the network, and register access points for Area Calls.

① Icom guarantees this function only for the AP-90M and AP-95M. (As of May, 2019)

**1 IP Address Range** .....

Click the <Search> button after entering the IP address range of the access points.

When starting a search, the button changes to both <Refresh> and <Cancel>.

The discovered access point information will be displayed in a list.

- ① When only IP start address is entered, a search starts.
- ① If BSSID is already registered in the Area Entry List, it is not displayed.
- ① When the [IP Advanced Radio System] setting of an access point that is set to “Enable” in [Notification] that is same Tenant (Fleet) Number with the RoIP Gateway, and a name is registered, you can search for the BSSID and name. When it is set to “Disable,” you cannot search with the RoIP Gateway.

(AP-95M Wireless LAN1 IP Advanced Radio System screen)

**2 Check Box** .....

Click a Check Box to add a check mark for registering a discovered access point.

- ① By clicking [All], you can select or cancel all access points in the list.

**3 Name** .....

The name that is set in [IP Advanced Radio System] of an access point is displayed.

- ① An area name is registered on [Number] in [Area Setting].

Area Call screen

Transceiver Controller > RoIP Server Settings > Area Call

■ Access Point Search

**Access Point Search**

\*Searches and lists access points that support this function.

IP Address Range : ① \_\_\_\_\_ - \_\_\_\_\_ Search

② <input type="checkbox"/> All	Host Name	IP Address	BSSID	Name ③	④ No.	⑤
<input type="checkbox"/>	AP-95M	192.168.0.10	00-90-C7-██████	Sales1	1 ▾	Add
<input type="checkbox"/>	AP-95M	192.168.0.11	00-90-C7-██████	Sales2	2 ▾	Add

⑥ Apply selection

④ No. ....

Select an area to register from a “Number” in [Area Setting].  
When an area number that is already registered is selected, BSSID is added to the area number.

- ① If the area number is already registered in [Area Call], it cannot be selected.
- ① An area number is selected, depending on the name that is registered with the same Tenant (Fleet) Number in [IP Advanced Radio System] of an access point, as shown below.
  - When the area number’s name is already registered in [Area Setting], the area number is selected (A blank is also recognized as a part of the name).
  - When the area number’s name is not registered in [Area Setting], an unused and initial area number is selected.

⑤ <Add> .....

Click to register a discovered access point in [Access Point Search].

⑥ <Apply selection> .....

Click to register a selected access point in [Check Box] (②).



## Area Call screen

Transceiver Controller > RoIP Server Settings > Area Call

### ■ Area Entry List

Display the list of the registered [Area Setting] or [Access Point Search].

Area Entry List				
No.	Name	BSSID	①	②
1	Sales1	00-90-C7-██████	Edit	Delete
2	Sales2	00-90-C7-██████	Edit	Delete
				③ Delete All

① <Edit> .....

Click to edit the setting in [Area Setting].

② <Delete> .....

Click to delete the selected entry.

① After clicking <Delete>, the entry cannot be recalled.

③ <Delete All> .....

Click to delete all the entries.

① After clicking <Delete All>, the entries cannot be recalled.

## Transceiver Management screen

Transceiver Controller > Transceiver Settings > Transceiver Management

### ■ Transceiver Management

The RoIP Gateway can monitor the registered IP100Hs and IP100FSs. And if necessary, the RoIP Gateway can reboot the registered all IP100Hs.

**Transceiver Management**

<input type="checkbox"/>	TRX No.	Transceiver Model	Name	Unit ID	Registration Status	IP Address	Current Status	Talkgroup	Location	Version
<input type="checkbox"/> All										
<input type="checkbox"/>	1	IP100H	Sales1	0101	Disconnected	-	-	-	-	-
<input type="checkbox"/>	2	IP100H	Sales2	0102	Connected	192.168.0.11	Meeting	1	00-90-C7- <span style="background-color: #ccc;">          </span>	Ver. <span style="background-color: #ccc;">      </span>
<input type="checkbox"/>	3	IP100H	Sales3	0103	Connected	192.168.0.12	Under a break	1	00-90-C7- <span style="background-color: #ccc;">          </span>	Ver. <span style="background-color: #ccc;">      </span>
<input type="checkbox"/>	50	IP100FS	IP100FS	0050	Disconnected	-	-	-	-	-

**Manual Reboot**

Manual Update :  Disable  Enable

Manual Reboot :

① An IP100H is displayed in bold when a setting is changed and a reboot is required.

**1 Check Box** ..... Click a Check Box to add a check mark to the IP100H that you want to reboot.  
 ① You cannot select an IP100FS, or an IP100H that has “Disconnected” displayed in [Registration Status].  
 ① By clicking the [All] box, you can select or cancel all IP100Hs in the list.

**2 Registration Status** ..... Displays the IP100Hs’ or IP100FSs’ Registration Status as either “Connected” or “Disconnected.”  
 ① Displays “Disconnected” if the IP100H is turned OFF or the IP100FS’s application is not running.  
 ① When the RoIP Gateway sends the reboot command to an IP100H from the [Transceiver Management] menu, the following status are displayed: “Receiving reboot command,” “Reboot command reception success,” “Reboot command reception failed,” “Ready to reboot” “Rebooting,” “Updating,” “Update failed,” “Downloading,” “Status notification failed,” and “Low battery.”

**3 IP Address** ..... Displays the IP Addresses of the IP100Hs or IP100FSs.  
 ① When [Registration Status] displays “Disconnected,” “-” is displayed.

**4 Current Status** ..... Displays the Current Status of the IP100Hs. (Example: In a meeting)

- ① Information**
- If the Status function is set to OFF, “-” is displayed.
  - If you click the <Refresh> (7) button, the latest status will be displayed.
  - When the IP100H is remotely locked by the IP100FS, and it cannot communicate with others or cannot transmit, “Transmit and receive disabled” or “Transmit disabled” is displayed.
  - If the IP100H is sending an emergency call, “Emergency” is displayed.

Transceiver Management screen

Transceiver Controller > Transceiver Settings > Transceiver Management

■ Transceiver Management

Transceiver Management										
<input type="checkbox"/> All	TRX No.	Transceiver Model	Name	Unit ID	Registration Status	IP Address	Current Status	Talkgroup	Location	Version
<input type="checkbox"/>	1	<b>IP100H</b>	Sales1	0101	Disconnected	-	-	-	-	-
<input type="checkbox"/>	2	IP100H	Sales2	0102	Connected	192.168.0.11	Meeting	1	00-90-C7- [REDACTED]	Ver. [REDACTED]
<input type="checkbox"/>	3	IP100H	Sales3	0103	Connected	192.168.0.12	Under a break	1	00-90-C7- [REDACTED]	Ver. [REDACTED]
<input type="checkbox"/>	50	IP100FS	IP100FS	0050	Disconnected	-	-	-	-	-

Manual Reboot

Manual Update :  Disable  Enable

Manual Reboot :

① An IP100H is displayed in bold when a setting has been changed and a reboot is required.

5 **Talkgroup** .....

Displays the Talkgroup IDs that are selected by the IP100Hs or IP100FSs.

- ① When a Talkgroup name is registered, a Talkgroup number (name) is displayed.
- ① While a IP100H or IP100FS does not select a Talkgroup, or [Registration Status] displays “Disconnected,” “-” is displayed.

6 **Location** .....

Displays the BSSIDs of the wireless access points that the IP100Hs are connected to.

- ① When [Registration Status] displays “Disconnected,” “-” is displayed.

7 **<Refresh>** .....

Click to reload the Registration Status.

- ① The connection status of the IP100H or IP100FS, or the activation status check of when the IP100H or IP100FS reboots are renewed.

8 **Version** .....

Displays the version of the IP100Hs or IP100FSs that are registered to the RoIP Gateway.

- ① When [Registration Status] displays “Disconnected,” “-” is displayed.

9 **Manual Update** .....

Enable to manually update the IP100H firmware when the RoIP Gateway sends Manual Reboot (10) to the IP100H. When the IP100H is ready to update the firmware, “F” blinks on the

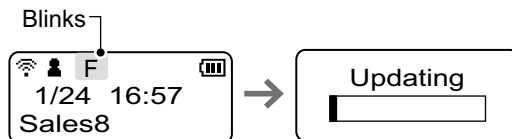

display, and then the IP100H automatically reboots and starts the firmware update.

- ① When the IP100H has failed to prepare a firmware update, the IP100H does not automatically reboot. If necessary, send a reboot command to the IP100H.

10 **Manual Reboot** .....

Click <Execute> to reboot all of the IP100Hs that are selected in [Check Box] (1).

## Transceiver Registration screen

Transceiver Controller > Transceiver Settings > Transceiver Registration

### ■ Transceiver Settings

Register the IP100H or IP100FS settings.

① After the registration is completed, you must reboot the IP100H.

**Transceiver Settings**

TRX No. : ① 1

Transceiver Model : ② IP100H

Name : ③ Sales1

Unit ID : ④ 0001

**Security**

Password : ⑤ iptrx

**Connection Port**

Transceiver Port Number : ⑥ 30000

Server Port Number : ⑦ 30000

**Profile**

Profile : ⑧ 1 (Sales group)

Add Reset

⑨ ⑩

- ① **TRX No.** ..... Selects the number that the IP100H or IP100FS is registered to. (Default: 1)  
① Up to 50 terminals can be registered.
- ② **Transceiver Model** ..... Select either the IP100H or IP100FS. (Default: IP100H)
- ③ **Name** ..... Enter a transceiver name of up to 31 characters.
- ④ **Unit ID** ..... Enter the 4 digit individual number between 0001 and 9999. (Default: 0001)
- ⑤ **Password** ..... Enter a password to access to the RoIP Gateway. (Default: iptrx)  
① Up to 12 characters, lower or upper letters, numbers, and symbols can be used.
- ⑥ **Transceiver Port Number** ..... Enter the port number (UDP port) that the IP100H will use to communicate with the RoIP Gateway.

**① Information**

- The set port number (RTP) and the port number +1 (RTCP) are used for communication.
- We basically recommend that you use the default port number.
- The default number differs, depending on [TRX No.], as shown below.  
Default: TRX No. 1 (30000), TRX No. 2 (30002), TRX No. 3 (30004), TRX No. 4 (30006), ....., TRX No. 50 (30098)
- Setting range: Even numbers between 2 and 59998.  
Some numbers may not be usable.
- Do not set the port number that has already been used by another connection setting.
- When [Transceiver Model] (②) is set to "IP100FS," the port number is not displayed.

Transceiver Registration screen

Transceiver Controller > Transceiver Settings > Transceiver Registration

■ Transceiver Settings

**Transceiver Settings**

TRX No. : ① 1

Transceiver Model : ② IP100H

Name : ③ Sales1

Unit ID : ④ 0001

**Security**

Password : ⑤ iptrx

**Connection Port**

Transceiver Port Number : ⑥ 30000

Server Port Number : ⑦ 30000

**Profile**

Profile : ⑧ 1 (Sales group)

⑨ Add    ⑩ Reset

⑦ **Server Port Number** .....

Enter a port number (UDP port) that the RoIP Gateway will use to communicate with the IP100H or IP100FS.

① **Information**

- The set port number (RTP) and the port number +1 (RTCP) are used for communication.
- We basically recommend that you use the default port numbers.
- The default number differs, depending on the [TRX No.] as shown below.  
 Default: TRX No. 1 (30000), TRX No. 2 (30002), TRX No. 3 (30004),  
 TRX No. 4 (30006), ....., TRX No. 50 (30098)
- Setting range: Even numbers between 2 and 65534.  
 Some numbers may not be usable.
- Do not set a port number that has already been used by another connection setting.

⑧ **Profile** .....

Select the Profile number that the IP100H or IP100FS belongs to.

(Default: 1)

- ① The numbers 1 to 50 are selectable.
- ① Set the Profile setting in the [Common Settings] menu, such as ID list, message, or Receive notification tone settings.

⑨ **<Add>** .....

Click to add the entries.

- ① The entries are displayed in [Transceiver Setting Entry List].

⑩ **<Reset>** .....

Click to reset the settings.

- ① You cannot reset after clicking <Add>.

Transceiver Registration screen

Transceiver Controller > Transceiver Settings > Transceiver Registration

### ■ Transceiver Setting Entry List

The list of the registered IP100Hs or IP100FSs.

<input type="checkbox"/> All	TRX No.	Transceiver Model	Name	Unit ID	Password	Connection Port		Profile	ID List	Message List	
						Transceiver	Server				
<input type="checkbox"/>	1	IP100H	Sales1	0101	iptrx	30000	3000	1	1	1	Delete
<input type="checkbox"/>	2	IP100H	Sales2	0102	iptrx	30002	3000	1	1	1	Delete
<input type="checkbox"/>	3	IP100H	Sales3	0103	iptrx	30004	3000	1	1	1	Delete
<input type="checkbox"/>	50	IP100FS	IP100FS	0050	iptrx	-	3009	1	1	1	Delete

- 1 Check Box** ..... Click a Check Box to add a check mark to delete an entry.  
 ① By clicking the [All] box, you can select or cancel all entries in the list.
- 2 <Delete>** ..... Click to delete the selected entry.  
 ① After clicking <Delete>, the entry cannot be recalled.
- 3 <Apply>** ..... Click to apply the entries.  
 ① The entries that are edited in [Transceiver Setting Entry List] are registered.
- 4 <Reset>** ..... Click to reset the settings.  
 ① You cannot reset after clicking <Apply>.
- 5 <Delete Selected>** ..... Click to delete an entry that you select in the Check Box (1).  
 ① After clicking <Delete Selected>, the entry cannot be recalled.
- 6 <Delete All>** ..... Click to delete all the entries.  
 ① After clicking <Delete All>, the entries cannot be recalled.

Transceiver Registration screen

Transceiver Controller > Transceiver Settings > Transceiver Registration

### ■ TRX Batch Setting

You can register consecutive Destination IDs collectively. Or you can copy the Destination ID contents to another ID.

**TRX Batch Setting**

Range : ① \_\_\_\_\_ - \_\_\_\_\_   
\* Enter Unit ID range.

Refer to : ② Default ▾  
\* [Transceiver Settings] applies the initial value.

Profile : ③ 1 (Sales group) ▾

- ① **Range** ..... Enter a range of collective Destination IDs.  
  
Click <Add> to register consecutive Destination IDs collectively in the box.  
① If a Destination ID is already registered, “Overwrite the following entry” is displayed.
  
- ② **Refer to** ..... Select the default settings or the programmed settings to refer to.  
(Default: Default)
  
- ③ **Profile** ..... Select the profile number that IP100Hs or IP100FSs belong to.  
(Default: 1)  
  
① The numbers 1 to 50 are selectable.  
① You can set an ID List, Message List, or Notification beep setting for each profile in the [Common Settings] menu.

# Transceiver Settings screen

Transceiver Controller > Transceiver Settings > Transceiver Settings

## ■ Transceiver Settings

Individually assign the functions, or set the receive notification tone to a registered IP100H.

① After the setting is completed, you must reboot the IP100H.

**Transceiver Settings**

---

**Display**

Unit ID : ① 0101 (Sales1) ▼

Display Item : ②  Date and Time  Name

BackLight : ③ Auto ▼

**Transmission**

Tx Inhibit : ④  Disable  Enable

PTT Lock : ⑤  Disable  Enable

**Destination ID**

PTT Call at Stand-by : ⑥  Disable  Enable \* The last-used ID display is hidden, if disabled.

Use ID List : ⑦  Disable  Enable

Default Destination ID : All ▼

Add All Call to ID List : ⑧  Disable  Enable

Default Talkgroup : ⑨  Disable  Enable

① Unit ID .....

Select the IP100H's Individual number (Name) that you want to edit.  
 ① Only the individual numbers of the IP100H are selectable.  
 The individual number that the [Transceiver Model] on the [Transceiver Registration] screen is set to "IP100FS," cannot be selected.

② Display Item .....

Select whether or not the IP100H displays the Date and Time or its Name in the standby mode. (Default: Date and Time)

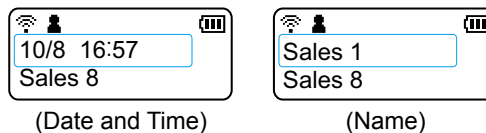

① If the [Name] on the [Transceiver Registration] screen has not been entered, and this setting is set to [Name], the IP100H displays the individual number.

③ BackLight.....

Select the IP100H backlight function. (Default: Auto)

- **OFF:** The backlight does not light.
- **ON:** The backlight lights continuously.
- **Auto:** The backlight lights when an operation is performed, and goes out after 5 seconds.

④ Tx Inhibit .....

Select "Enable" to inhibit the IP100H's transmission. (Default: Disable)  
 ① When this setting is set to "Enable," the IP100H also cannot transmit with an optional microphone, or using the VOX function.



## Transceiver Settings screen

Transceiver Controller > Transceiver Settings > Transceiver Settings

### ■ Transceiver Settings

**Transceiver Settings**

---

Unit ID : ① 0101 (Sales1) ▼

**Display**

Display Item : ②  Date and Time  Name

BackLight : ③ Auto ▼

**Transmission**

Tx Inhibit : ④  Disable  Enable

PTT Lock : ⑤  Disable  Enable

**Destination ID**

PTT Call at Stand-by : ⑥  Disable  Enable \* The last-used ID display is hidden, if disabled.

Use ID List : ⑦  Disable  Enable

Default Destination ID : All ▼

Add All Call to ID List : ⑧  Disable  Enable

Default Talkgroup : ⑨  Disable  Enable

⑤ **PTT Lock** ..... Select "Enable" to lock the IP100H's PTT switch. (Default: Disable)  
 ⓘ When this setting is set to "Enable," the IP100H cannot transmit by holding down its PTT switch, but it can transmit with an optional microphone or using the VOX function as well.

⑥ **PTT Call at Stand-by** ..... Select whether or not the IP100H displays the Destination ID (Call type) in the standby mode. (Default: Enable)

- **Disable:** The Destination ID (Call type) is not displayed in the standby mode.  
 ⓘ The Destination ID (Call type) is displayed when you select the ID using the function keys.
- **Enable:** The Destination ID (Call type) is displayed in the standby mode.  
 ⓘ When the PTT on the IP100H is pushed, the IP100H calls the displayed ID (Call type).

## Transceiver Settings screen

Transceiver Controller > Transceiver Settings > Transceiver Settings

### ■ Transceiver Settings

**Transceiver Settings**

---

Unit ID : ① 0101 (Sales1) ▼

**Display**

Display Item : ②  Date and Time  Name

BackLight : ③ Auto ▼

**Transmission**

Tx Inhibit : ④  Disable  Enable

PTT Lock : ⑤  Disable  Enable

**Destination ID**

PTT Call at Stand-by : ⑥  Disable  Enable \* The last-used ID display is hidden, if disabled.

Use ID List : ⑦  Disable  Enable

Default Destination ID : ▼

Add All Call to ID List : ⑧  Disable  Enable

Default Talkgroup : ⑨  Disable  Enable

#### ⑦ Use ID List .....



(Address) key

Select whether or not the IP100H uses the ID list. (Default: Disable)

#### • Disable:

The call type is fixed to that which is selected in the [Call Type], as shown below, even if you push the  key on the IP100H.

- ① If you set the Call Type to "Individual" or "Group," enter the 4 digit destination ID in the [Destination ID]. (Default: All)
- ① Even if "Disable" is selected, the IP100H displays a received ID in the ID list.

Use ID List :  Disable  Enable

Call Type : All ▼

#### • Enable:

The call type is changed by pushing the  key on the IP100H. Select First Call ID from All, or an ID number (1 to 50) that is displayed when the IP100H is turned ON, in [Call type].

- ① The ID list is selected on the [Common Setting] screen.

## Transceiver Settings screen

Transceiver Controller > Transceiver Settings > Transceiver Settings

### ■ Transceiver Settings

**Transceiver Settings**

---

Unit ID : ① 0101 (Sales1) ▼

**Display**

Display Item : ②  Date and Time  Name

BackLight : ③ Auto ▼

**Transmission**

Tx Inhibit : ④  Disable  Enable

PTT Lock : ⑤  Disable  Enable

**Destination ID**

PTT Call at Stand-by : ⑥  Disable  Enable \* The last-used ID display is hidden, if disabled.

Use ID List : ⑦  Disable  Enable

Default Destination ID : ▼

Add All Call to ID List : ⑧  Disable  Enable

Default Talkgroup : ⑨  Disable  Enable

⑧ **Add All Call to ID List** ..... Select whether or not to display All Call in the ID list of the IP100H.  
(Default: Enable)

• **Disable**

Does not display “All” in the ID list.

① When “Disable” is selected in [Add All Call to ID List], you cannot select an All call using the [☐] key.

• **Enable**

① When [User ID List] (⑦) is set to “Enable,” set [Add All Call to ID List] and [Startup Talkgroup].

⑨ **Default Talkgroup** ..... Select a Talkgroup if you want to set the IP100H to join a Talkgroup when you turn ON the power.  
(Default: Disable)

• **Disable**

The IP100 starts up without joining any Talkgroup. The ID that is set in the “First Call ID” in [User ID List] (⑦) is displayed when the IP100H is turned ON.

• **Enable**

The IP100 joins the selected Talkgroup when it is turned ON.

① When [User ID List] (⑦) is set to “Disable,” this item is not displayed.

Default Talkgroup :  Disable  Enable

Call ID : 13 (TG1) ▼

Transceiver Settings screen

Transceiver Controller > Transceiver Settings > Transceiver Settings

■ Transceiver Settings

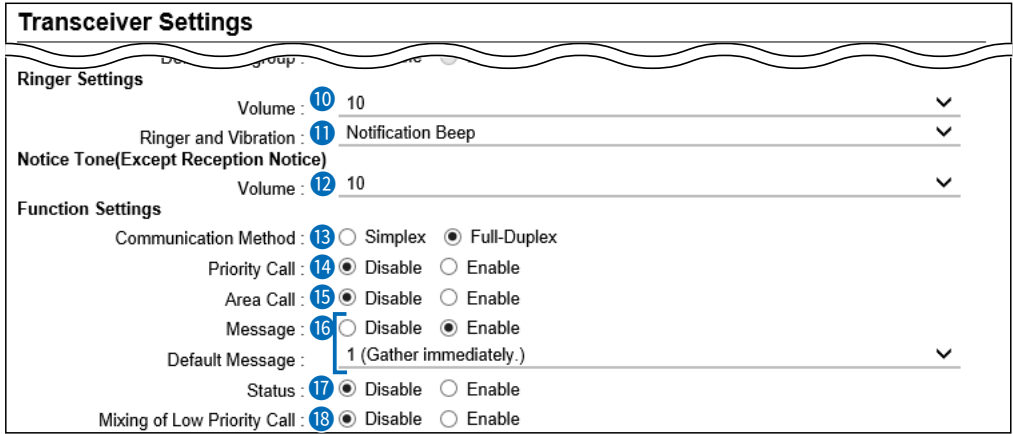

① The screen shows when the Message (16) is set to “enable.”

**10 Volume** ..... Set the beep level when the IP100H receives a Call or message to between 0 and 32. (Default: 10)  
 ① When this setting set to “0,” the notification beep is turned OFF.  
 ① The notification beep is individually set for the Call type or message in [Notification Tone] on the [Common Settings] screen.

**11 Ringer and Vibration**..... Set the action when the IP100H receives a Call or message to “Notification Beep,” “Vibration” or “Notification Beep + Vibration.” (Default: Notification Beep)

- **Notification Beep**  
 When the IP100H receives a Call or message, the specified Notification beep sounds, depending on the Call or message. The notification beep is set in [Notification Tone] on the [Profile] screen in the [Common Settings] menu.
- **Vibration**  
 When the IP100H receives a Call or message, it vibrates for notification.
- **Notification Beep + Vibration**  
 When the IP100H receives a Call or message, it vibrates and the Notification beep sounds for notification.

Transceiver Settings screen

Transceiver Controller > Transceiver Settings > Transceiver Settings

■ Transceiver Settings

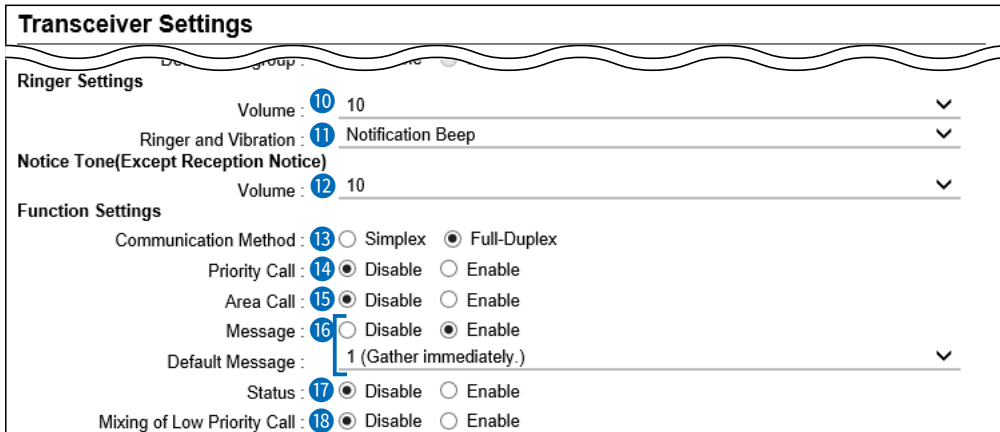

① The screen shows when the Message (16) is set to “enable.”

12 Volume (Except Reception Notice)

Set the beep level when the IP100H is transmitting a Call or connecting to the RoIP Gateway, to between 0 and 32. (Default: 10)

① When this setting is set to “0,” the notification beep is turned OFF.

① Depending on the [Common Settings], the IP100H sounds a beep when the IP100H is transmitting or connecting to the RoIP Gateway.

13 Communication Method ...

Select the communication method that the IP100H uses.

(Default: Full-Duplex)

- **Simplex:** Toggles the transmission (Talker) and reception (Listener) for communication.
- **Full-duplex:** Simultaneously transmits and receives, like a telephone.
  - ① When connecting the optional microphone to the IP100H, you can operate the IP100H like a telephone.

Simplex and Full-duplex

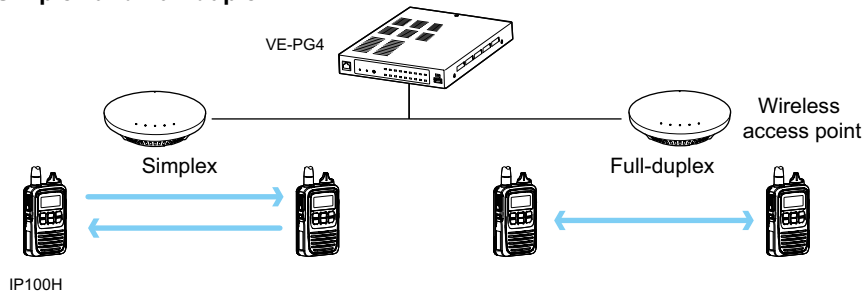

Transceiver Settings screen

Transceiver Controller > Transceiver Settings > Transceiver Settings

■ Transceiver Settings

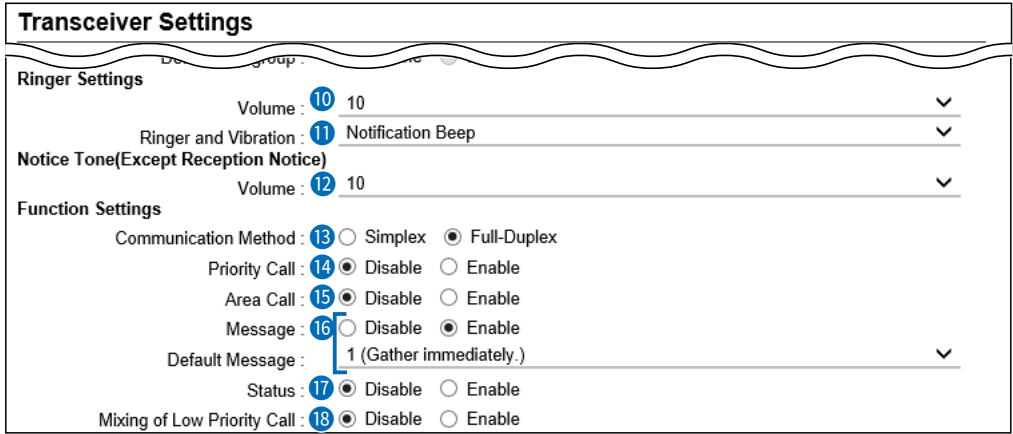

① The screen shows when the Message (16) is set to “enable.”

14 Priority Call ..... Select whether or not the IP100H uses Priority Call. (Default: Disable)

The priority levels of the Call types are in the following order.

Priority level	Priority	Call type	Priority Call	Remarks
High ↑       ↓ Low	Fixed	Telephone	—	For telephone communication
		Emergency (High)	Enable	—
		Emergency (Normal)	Disable	—
	Selectable *	All Call (High)	Enable	Includes the Area Call or using an IP100FS
		Individual Call (High)	Enable	Includes using an IP100FS
		Group Call (High)	Enable	Includes the Area Call or using an IP100FS
		All Call (Normal)	Disable	Includes the Area Call
		Individual Call (Normal)	Disable	—
		Group Call (Normal)	Disable	Includes the Area Call

\* Selectable in the Call Type Priority in the [RoIP Server] screen in the [RoIP Server settings] menu.

- ① Priority is given to the first call between calls with the same priority level.
- ① When a call is taken, priority is given to the setting of the caller.

**Example:**

Even while B and C are talking on a Group Call from A, B can make an Individual Call (High) to C. In this case, the Group Call is canceled.

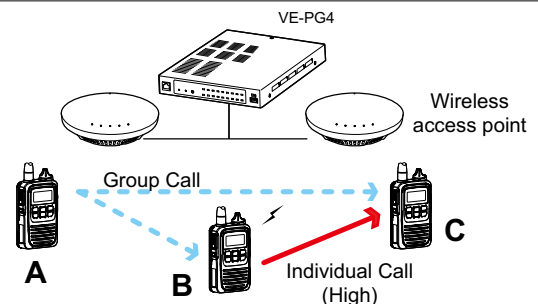

Transceiver Settings screen

Transceiver Controller > Transceiver Settings > Transceiver Settings

■ Transceiver Settings

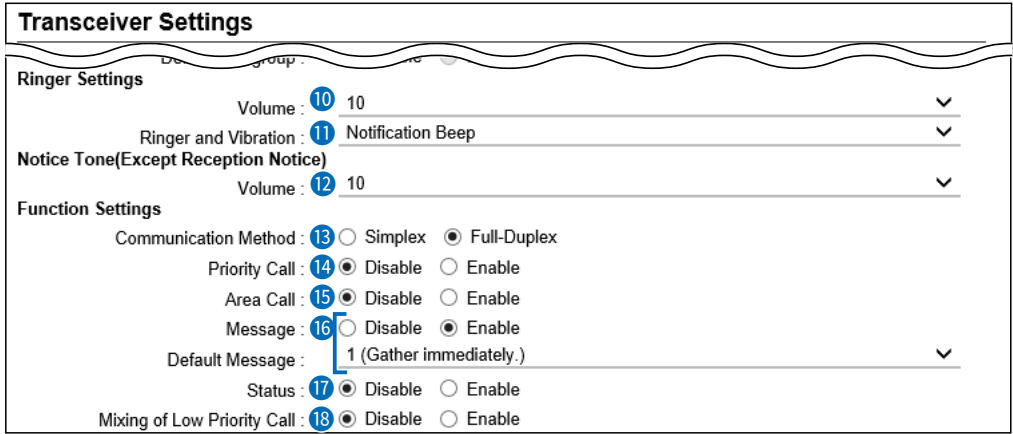

① The screen shows when the Message (16) is set to “enable.”

**15 Area Call** ..... Select whether or not the IP100H uses Area Call. (Default: Disable)

When the IP100H calls All Call or Group Call using the Area Call function, it calls only other IP100Hs or IP100FSs in the area that is connected to the same wireless access point. When the BSSID that IP100H is connecting is registered in [Area Setting] (Transceiver Controller > RoIP Server Settings > Area Call), this function is activated.

**IP100H makes an All Call with the Area Call function**

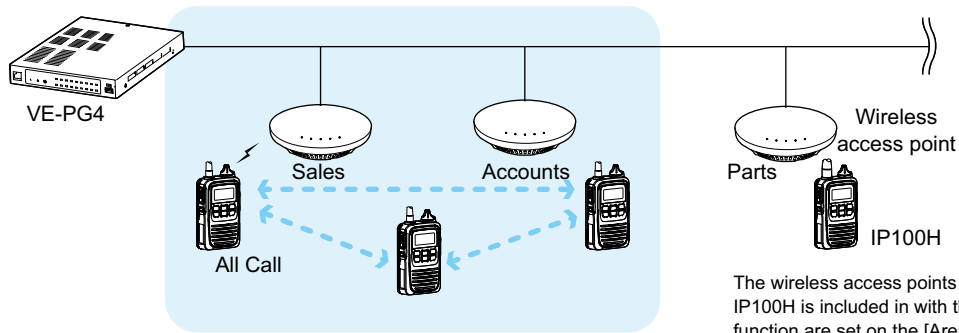

The wireless access points that the IP100H is included in with the Area Call function are set on the [Area Call] screen in the [RoIP Server Settings] menu. (Example: For Sales and For Accounts)

**IP100FS calls the All Call with the Area Call function**

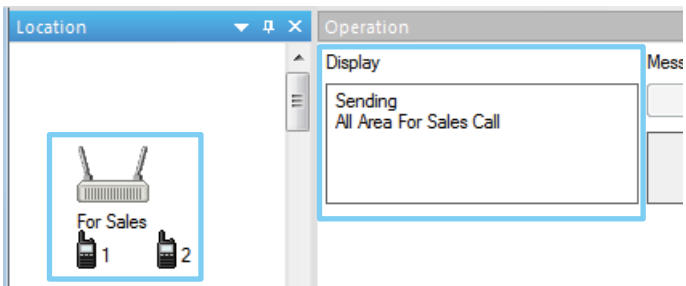

When the IP100FS uses Area Call function, the IP100FS can call IP100Hs that are in the communication range of the access points assigned to the Area Call. When the access point is selected in the [Location], the Call type (Individual, Group, All, Area, or Telephone) and names are displayed.

Transceiver Settings screen

Transceiver Controller > Transceiver Settings > Transceiver Settings

■ Transceiver Settings

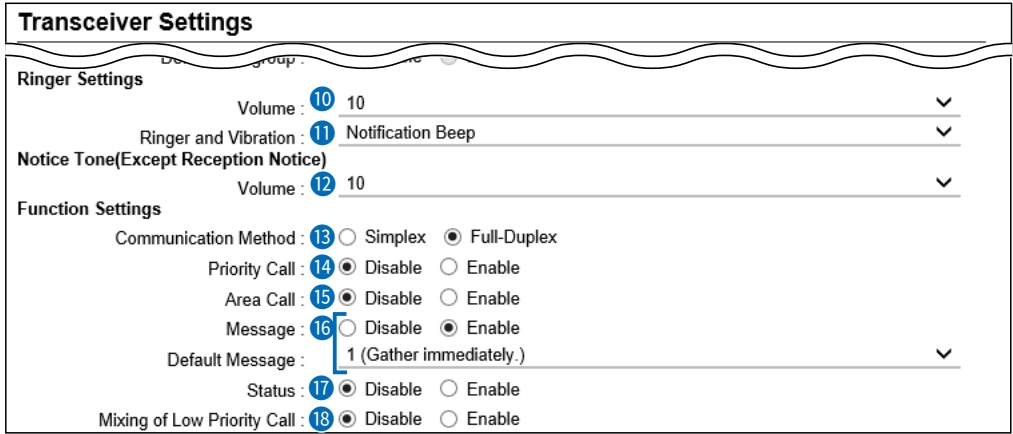

① The screen shows when the Message (16) is set to “enable.”

16 Message ..... Select whether or not the IP100H can send messages. (Default: Disable)

When “Enable” is selected, push the [FUNC] key on the IP100H once to enter the Message selection screen.

① Up to 10 messages of 32 characters or less can be programmed on the [Messages] screen in the [Common Settings] menu.

① Select the message number 1 to 10 in [Default Message] that is registered on the [Message] screen.

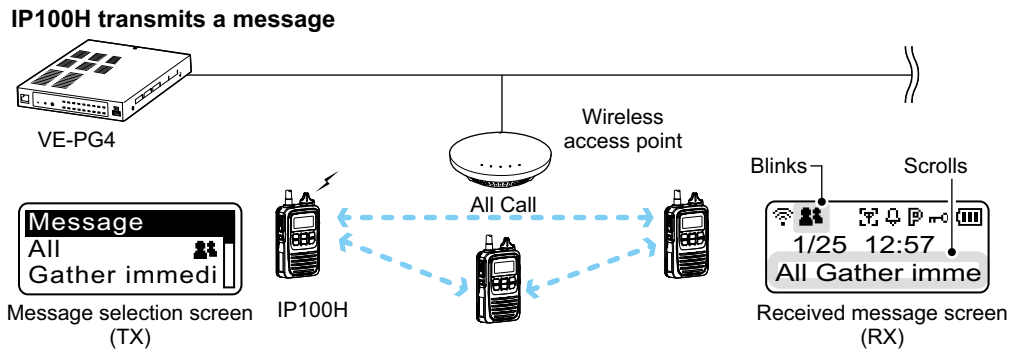

IP100FS transmits a message

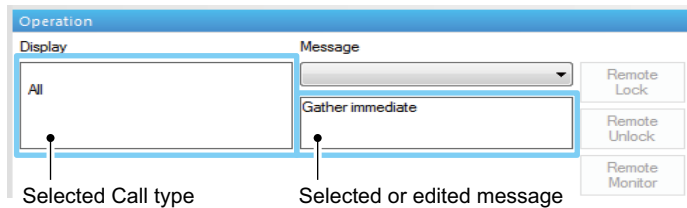

The IP100FS can store up to 100 messages in each site. You can edit the stored messages.



Transceiver Settings screen

Transceiver Controller > Transceiver Settings > Transceiver Settings

■ Transceiver Settings

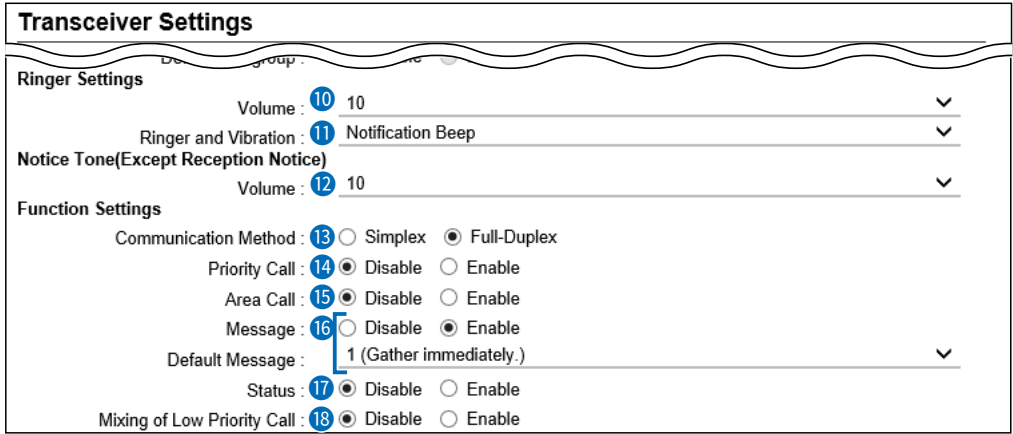

① The screen shows when the Message (16) is set to “enable.”

17 Status .....

Select whether or not the IP100H can send Status information. (Example: At lunch, Meeting, Waiting) (Default: Disable)  
 When “Enable” is selected, push the [FUNC] key on the IP100H twice to enter the Status selection screen.  
 ① Up to 10 statuses of 32 characters or less can be entered on the [Status] screen in the [Common Settings] menu.  
 ① The status that the IP100H sends can be displayed on the [Transceiver Management] screen in the [Transceiver Settings] menu or the one-Touch button of the IP100FS.

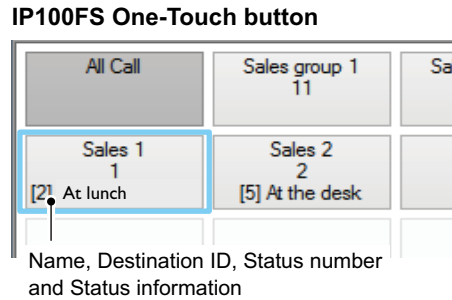
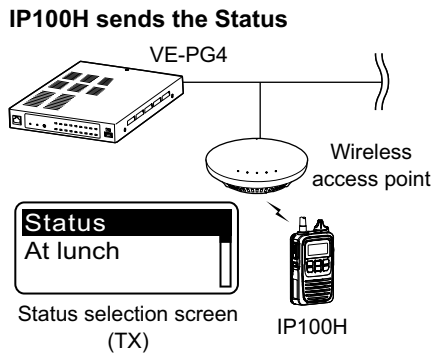

VE-PG4 Transceiver Management screen

Transceiver Management

<input type="checkbox"/>	All	TRX No.	Transceiver Model	Name	Unit ID	Registration Status	IP Address	Current Status	Talkgroup
<input type="checkbox"/>	1	1	IP100H	Sales1	0001	Connected	192.168.0.201	At lunch	1
<input type="checkbox"/>	2	2	IP100H	Sales2	0002	Connected	192.168.0.202	At th desk	1
<input type="checkbox"/>	3	3	IP100H	Sales3	0003	Disconnected	-	-	-
<input type="checkbox"/>	50	50	IP100FS	IP100FS	0050	Disconnected	-	-	-

Status

Transceiver Settings screen

Transceiver Controller > Transceiver Settings > Transceiver Settings

■ Transceiver Settings

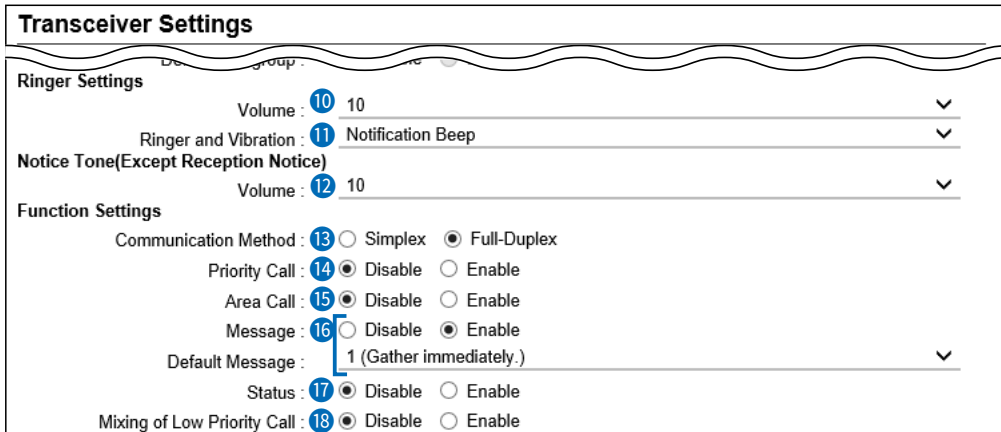

① The screen shows when the Message (16) is set to “enable.”

18 Mixing of Low Priority Call

Select whether or not the IP100H receives Mixed audio. (Default: Disable)

When this setting is set to “Enable,” the RoIP Gateway sends the mixed audio of all calls that call the IP100H.

① The IP100H displays the called station that has the highest priority in the mixed audio.

See page 6-26 for details of the Priority level.

• Mixing of Low priority call

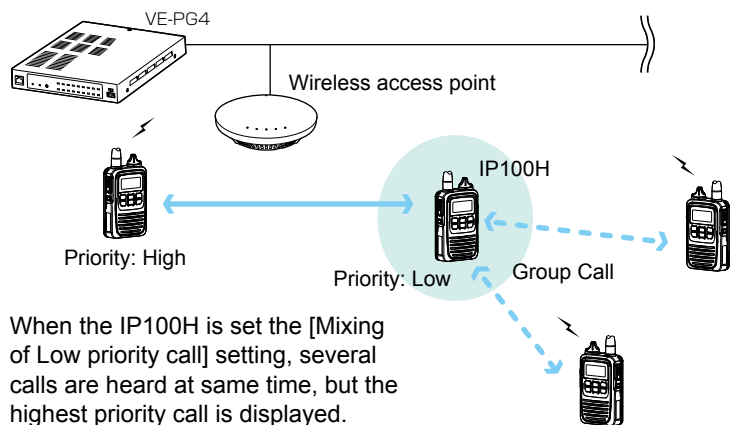

When the IP100H is set the [Mixing of Low priority call] setting, several calls are heard at same time, but the highest priority call is displayed.

Transceiver Settings screen

Transceiver Controller > Transceiver Settings > Transceiver Settings

■ Transceiver Settings

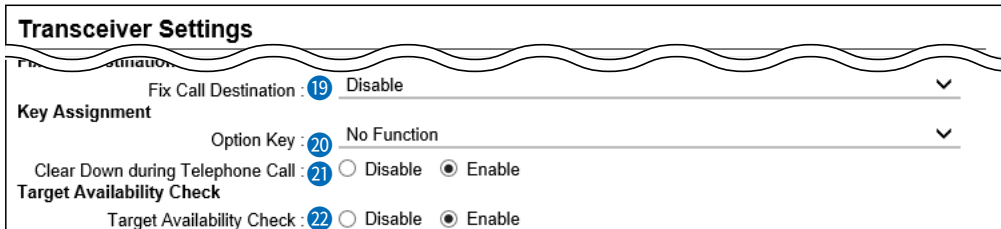

19 Fix Call Destination .....

Select whether or not the IP100H uses the Fix Call Destination function. (Default: Disable)

When this setting is set to other than “Disable,” the IP100H calls the preset destination instead of the selected destination that is displayed on the third line. The Fix Call Destination function separates the fixed call from the general calls by the specified method to start transmission.

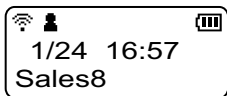

Call type is set to All

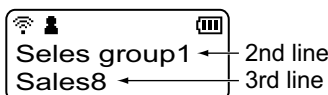

Call type is set to Group

• **Disable**

The Fix Call Destination is not specified, and the IP100H calls the selected destination.

• **PTT**

The Fix Call Destination is specified as PTT transmission. When [PTT] is held down, the IP100H calls the preset destination.

Fix Call Destination	
Fix Call Destination :	PTT
Call Type :	All

(Example: All call is specified to the PTT)

• **Earphone Mic or Headset**

The Fix Call Destination is specified as the external Mic transmission. When the external microphone’s PTT switch is held down, or its VOX function is active, the IP100H calls the preset destination.

Fix Call Destination	
Fix Call Destination :	Earphone Mic or Headset
Call Type :	Group
Destination ID :	0001

(Example: Group call is specified to the Earphone Mic or Headset)

① **Information**

- Set the Call type to “Individual,” “Group,” or “All.”
- When the “Call Type” is set to “Individual” or “Group,” enter the 4 digit number of the Individual ID or Group ID in the [Destination ID].
- The Destination ID, Name (if [Name] is selected in the [Display Item] (2)) or Call type of the Fix Call Destination is displayed on the 2nd line. (Usually Date and Time or Own Name is displayed on the 2nd line.)
- When the IP100H receives a call with this setting, it does not display the Caller’s ID or Call type on the 3rd line.
- When both of the IP100H’s [PTT] and external microphone’s PTT switch are held down, the external PTT has priority and the internal microphone will be muted.

Transceiver Settings screen

Transceiver Controller > Transceiver Settings > Transceiver Settings

■ Transceiver Settings

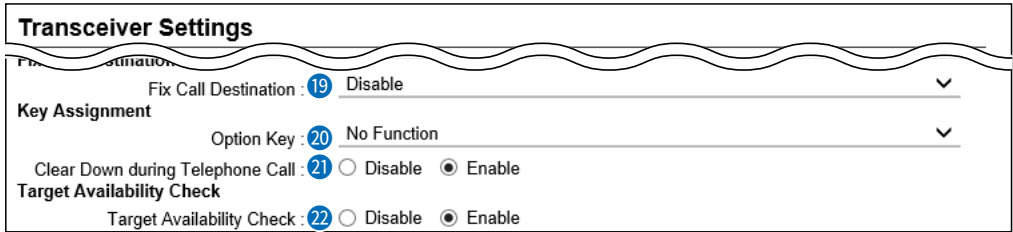

20 Option Key .....

Assign “Message,” “One Touch,” “Clear Down,” “Mute,” “Emergency,” or “No Function” to the IP100H’s [Option] key. (Default: No Function)

① When this setting is set to “No function,” nothing changes by pushing the [Option] key on the IP100H in the standby mode.

• **Message**

Pushing the [Option] key on the IP100H displays the Message selection screen.

① Select the message number 1 to 10 in the [Message No.] that is displayed on the [Message] screen.

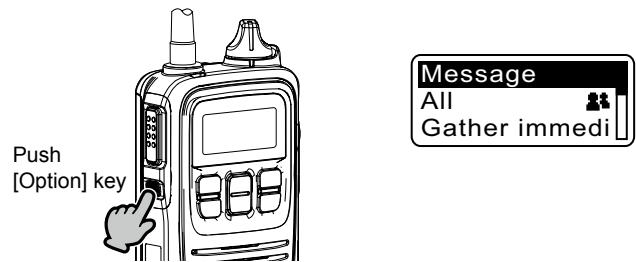
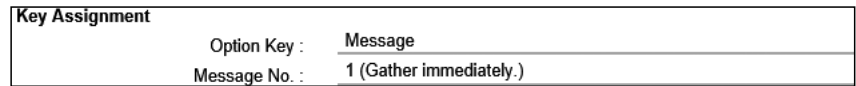

Transceiver Settings screen

Transceiver Controller > Transceiver Settings > Transceiver Settings

■ Transceiver Settings

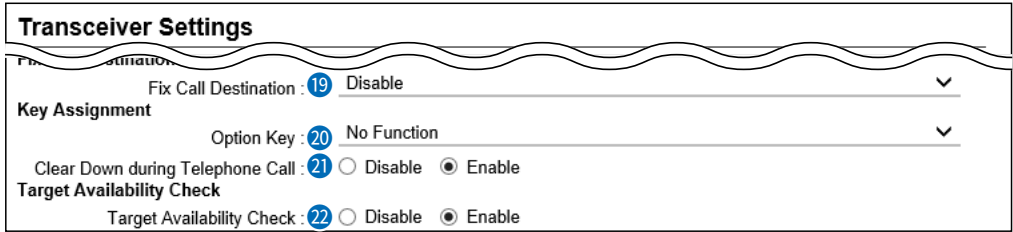

20 Option key .....

• One Touch

Pushing the [Option] key on the IP100H selects a specified Call type and destination ID or phone number.

Select the "Individual," "Group," "All," or "Telephone" Call type.

- ① When "Individual" or "Group" is selected, enter the 4 digit Individual ID or Group ID in the [Destination ID].
- ① When "Telephone" is selected, enter up to 31 numbers and symbols (#, \*) in the [Destination Phone Number].

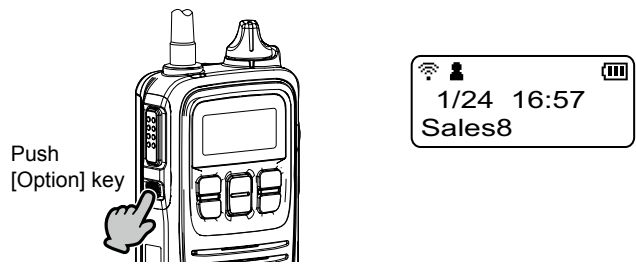
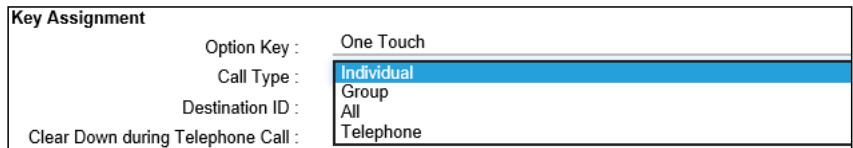

Transceiver Settings screen

Transceiver Controller > Transceiver Settings > Transceiver Settings

■ Transceiver Settings

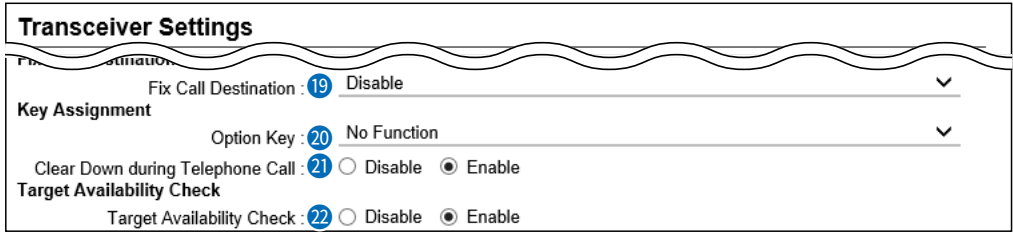

20 Option key .....

• **Clear Down**

Pushing the [Option] key on the IP100H terminates the phone call with an IP phone.

① You can assign another function if you select “Enable” on [Clear Down during Telephone Call] (21).

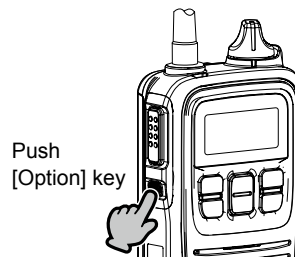
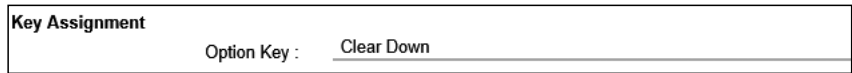

When the [Option] key is pushed before a phone call is received, or during telephone call, the phone call is terminated.

① The phone call is terminated from the IP100H, only when the IP100H is individually called from a telephone, or when the IP100H calls a telephone.

Transceiver Settings screen

Transceiver Controller > Transceiver Settings > Transceiver Settings

■ Transceiver Settings

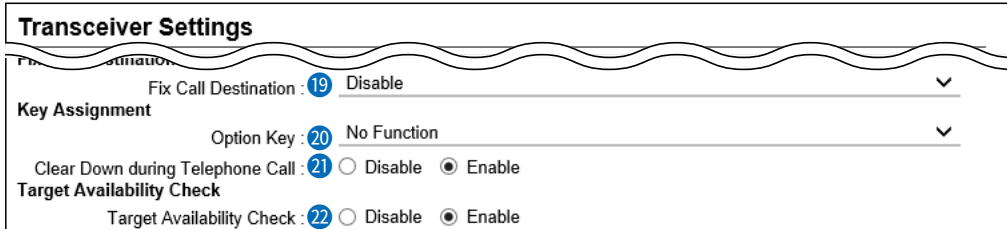

20 Option key .....

• Mute

- Hold down the [Option] key for 1 second on the IP100H when you want to mute the received audio. (The Notification beep cannot be muted.)
- Hold down the [Option] key for 1 second to turn the Mute function ON or OFF.
- ① You can turn OFF the Mute function by pushing [PTT]. However, selecting "Enable" in the [Clear Down during Telephone Call] (21), terminates the phone call.
- ① If you select "Enable" in [Mute Automatic Release], turn OFF the Mute function after a specified period of time has passed. (Default: Disable)
- If you select "Enable," set the period of time to release the Mute function to between 10 to 600 (seconds). (Default: 60 (seconds))

Key Assignment	
Option Key :	Mute
Mute Automatic Release :	<input type="radio"/> Disable <input checked="" type="radio"/> Enable
Mute Automatic Release Timer :	60

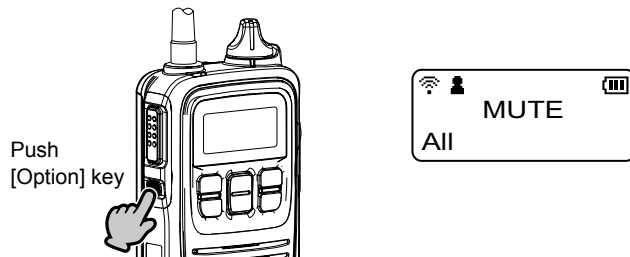

Transceiver Settings screen

Transceiver Controller > Transceiver Settings > Transceiver Settings

■ Transceiver Settings

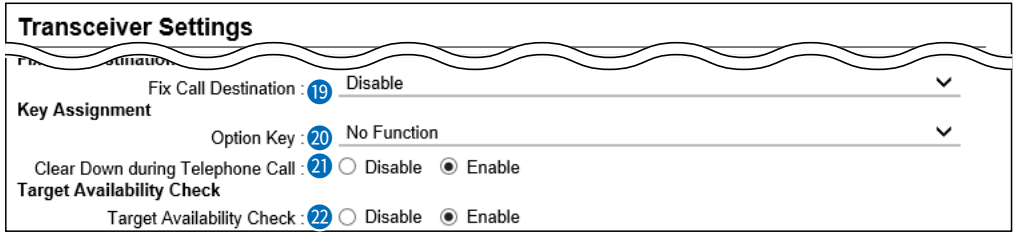

20 Option key .....

• **Emergency**

Hold down the [Option] key until “Emergency” is displayed to send an Emergency call.

When the Emergency call is sent, an alarm sounds. The Emergency call is canceled and the alarm stops when the transceiver receives a response, or the [Option] key of the transceiver is held down.

- ① You can set the period of time to send the Emergency call, and sound the alarm, in [Emer SW ON Timer] (35).
- ① When “Enable” is selected in [Emer SW OFF] (36), you can set the period of time to cancel the Emergency call and stop the alarm.

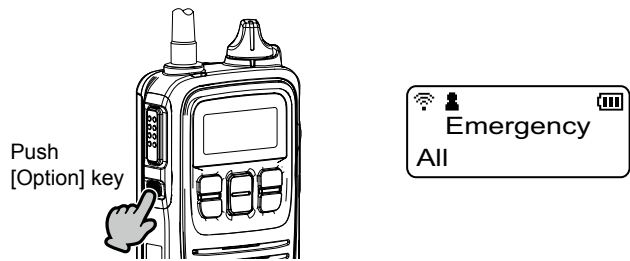

**NOTE:**

The RoIP Gateway should not be used when high reliability is necessary. The communication cannot be made, depending on the environment around the RoIP Gateway, such as the consumption of a battery, the signal environment, or the access point or network status. Use the [Emergency] and [Lone Worker] functions as a supplementary function.



Transceiver Settings screen

Transceiver Controller > Transceiver Settings > Transceiver Settings

■ Transceiver Settings

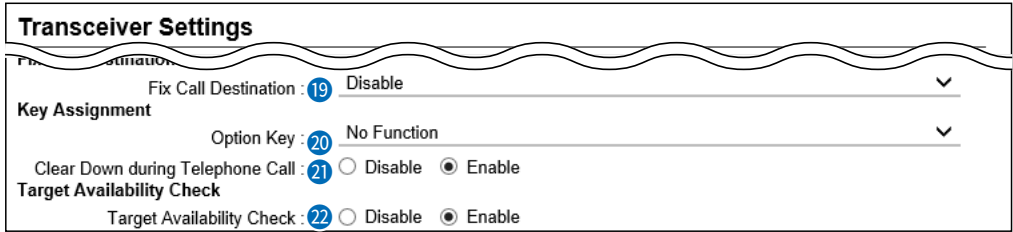

21 Clear Down during Telephone Call

Select “Enable,” if you want to terminate a phone call by pushing the IP100H’s [Option] key. (Default: Enable)  
 ① When “Clear Down” is selected on the [Option Key] (20), this item is not displayed.

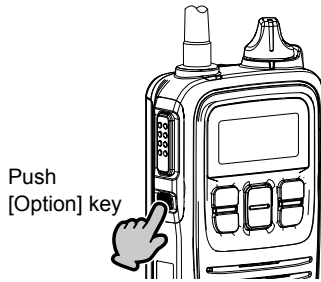

Before the target telephone is picked up, or during a phone call, pushing the [Option] key terminates the phone call.

① The IP100H can terminate the phone call, when a telephone calls the IP100H individually, or when the IP100H calls a telephone.

22 Target Availability Check ...

Select whether or not the IP100H displays a confirmation after it makes an Individual Call. (Default: Enable)  
 When “Enable” is selected, the IP100H displays the “Connected,” “Busy” or “No response” connection status.

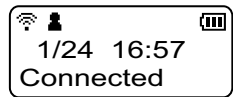

① When the target station is out of range, “No response” is displayed.  
 ① If the [Connection Notice Tone] is set to “Enable,” the Success Tone or Failure Tone sounds to notify its connection status.  
 (Transceiver Controller > Common Settings > Profile > Profile > Connection Notice Tone)

Transceiver Settings screen

Transceiver Controller > Transceiver Settings > Transceiver Settings

■ Transceiver Settings

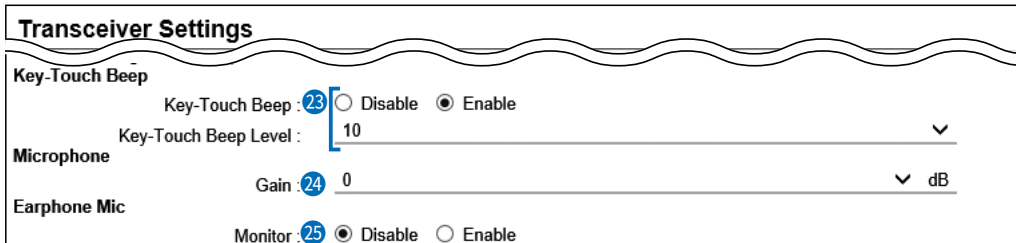

**23 Key-Touch Beep**..... Select whether or not the IP100H sounds the Key-Touch beep. (Default: Enable)  
 When “Disable” is selected, the IP100H does not sound the confirmation beep when a key is pushed.

- **Key-Touch Beep Level**  
 Set the volume level of the notification beeps when the IP100H’s key is pushed. (Default: 10)  
 The selectable range is between 0 and 32.
  - ① When “0” is selected in this setting, the IP100H does not sound any beep, even if the volume level is set.
  - ① When “Disable” is selected, this setting is grayed out and the volume level cannot be changed.

**24 Gain** ..... Adjust the microphone sensitivity. (Default: 0 (dB))  
 • Range: –12 (low) ~ 12 (high) dB, in 3 dB steps.  
 ① When the noise level around the IP100H is high, set to low sensitivity and speak in a slightly louder voice that makes listening easier. Or when the noise level around the IP100H is quiet, set to high sensitivity and speak in smaller voice that makes listening easier.

**25 Monitor** ..... Select whether or not the IP100H with an earphone microphone uses the Monitor function. (Default: Disable)  
 When this setting is set to “Enable,” you can hear your transmit audio from the earphone. Set the monitor level to between 0 and 32. (Default: 10)  
 ① When “0” is set, your voice is not heard from an earphone microphone, regardless of the audio setting in the IP100H.  
 ① To prevent howling, set this setting to “Disable” when using a speaker microphone, such as the HM-186LS.

Transceiver Settings screen

Transceiver Controller > Transceiver Settings > Transceiver Settings

■ Transceiver Settings

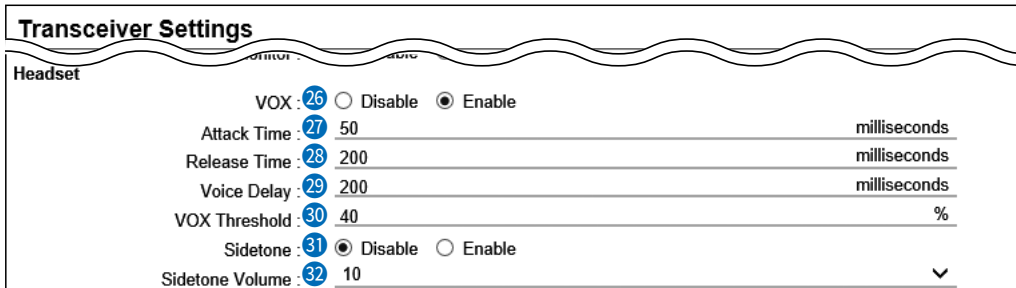

(This is an example of when the [VOX] (26) is set to “Enable.”)

26 VOX .....

Select whether or not the IP100H can use the VOX (voice operated transmission) function. (Default: Disable)  
The transceiver has a VOX function, which allows hands-free operation.

ⓘ Information

- The VOX function requires an optional headset and connection cable, such as the HS-94, HS-95, or HS-97 headset and OPC-2006LS cable, or the HS-102 headset and OPC-2359 cable.
- The VOX function starts transmission when you speak into the microphone, without needing to push [PTT]; then, automatically returns to reception when you stop speaking.
- Be sure to turn OFF the IP100H’s power, before connecting or disconnecting optional equipment to or from the [ / ] jack.
- When “Enable” is selected, the [Attack Time] (27) through [Sidetone Volume] (32) is displayed.

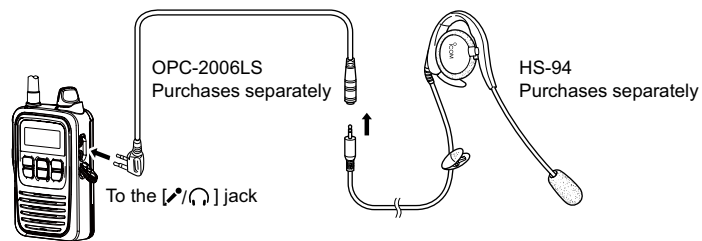

- The HS-85 has the VOX function, so if you connect the HS-85 to the IP100H through the OPC-2144, set the [VOX] (26) to “Disable.”

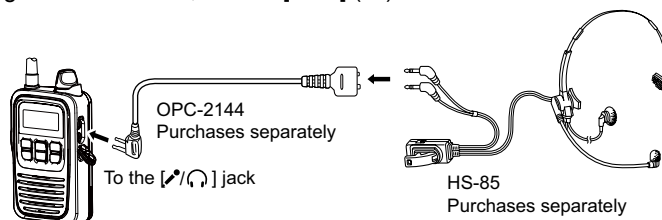

Transceiver Settings screen

Transceiver Controller > Transceiver Settings > Transceiver Settings

■ Transceiver Settings

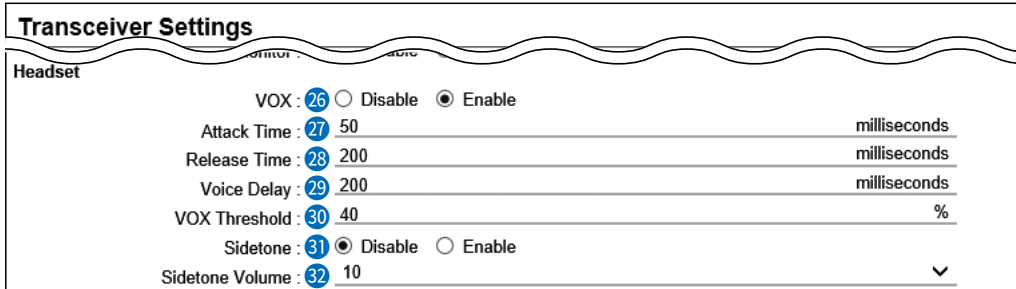

(This is an example of when the [VOX] (26) is set to “Enable.”)

- 27 Attack Time** ..... Adjust the Attack time (Default: 50)

• Range: 5 ~ 2000 (milliseconds) in 5 millisecond steps

When audio from a headset microphone is input for this specified time, the IP100H starts transmitting.

VOX: Enable
- 28 Release Time** ..... Adjust the Release time. (Default: 200)

• Range: 5 ~ 2000 (milliseconds) in 5 millisecond steps

The release time is amount of time the transmitter stays ON after you stop speaking.

VOX: Enable
- 29 Voice Delay** ..... Adjust the Voice Delay time to prevent clipping of the first few syllables after you begin speaking. (Default: 200)

• Range: 0 ~ 500 (milliseconds) in 5 millisecond steps

VOX: Enable
- 30 Voice Threshold** ..... Adjust the VOX Threshold level. (Default: 40)

• Range: 0 ~ 100 (%)

① The higher values make the VOX function more sensitive to your voice.

VOX: Enable
- 31 Sidetone** ..... Select whether or not to use the Sidetone function. (Default: Disable)

When “Enable” is selected, you can hear your voice from the headset.

VOX: Enable
- 32 Sidetone Volume** ..... Adjust the Sidetone level. (Default: 10)

• Range: 0 (minimum) ~ 32 (maximum)

VOX: Enable

Transceiver Settings screen

Transceiver Controller > Transceiver Settings > Transceiver Settings

■ Transceiver Settings

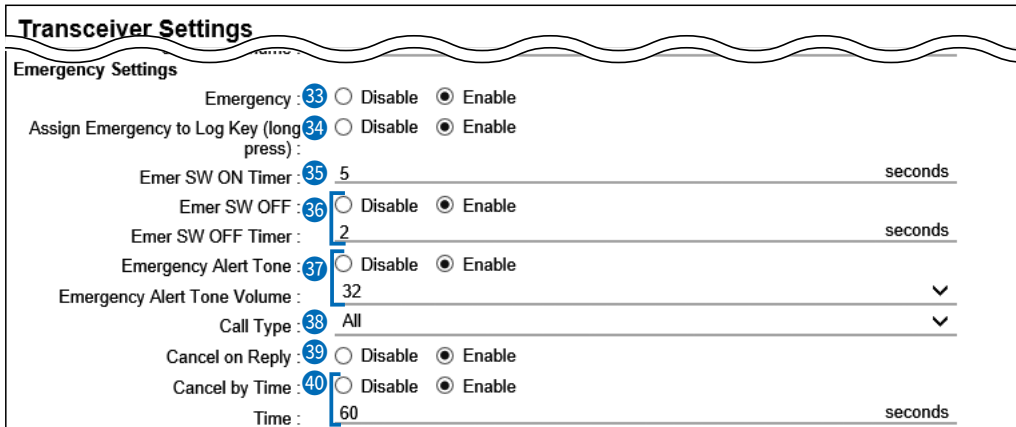

① (This is an example of when the Emergency (33), Emer SW OFF (36), and Cancel by Time (40) are set to “Enable.”)

- 33 Emergency** ..... Select whether or not to use the Emergency function. (Default: Disable)  
 Holding down the [Option Key] (20) or [Assign Emergency to Log Key (long press)] (34) until “Emergency” is displayed turns ON the Emergency function, and sends an Emergency call to the previously set User ID.  
 The Emergency call is canceled when an RX code is received, or holding down the [Option] key or [Log] key for a set period of time in the [Emer SW OFF Timer] (36).  
 • The period of time that the key must be held down to turn the Emergency function ON or OFF is set in the [Emer SW ON Timer] (35) or in the [Emer SW OFF Timer] (36).
- 34 Assign Emergency to Log Key (long press)** ..... Select whether or not to use the [☰] key to send an Emergency call. (Default: Enable)  
 Emergency: Enable
- 35 Emer SW ON Timer** ..... Enter the period of time for which the [Option] key or [Log] key must be held down to turn the Emergency function ON. (Default: 5 seconds)  
 Emergency: Enable
- 36 Emer SW OFF** ..... Select whether or not to cancel the Emergency call by pushing the [Option] key or [Log] key. (Default: Disable)  
 When “Enable” is selected, enter the period of time for which the [Option] or [Log] key must be held down to turn OFF the Emergency function, between 1 and 10 seconds. (Default: 2 seconds)  
 Emergency: Enable

Transceiver Settings screen

Transceiver Controller > Transceiver Settings > Transceiver Settings

■ Transceiver Settings

The screenshot shows the 'Transceiver Settings' screen with the following settings:

- Emergency Settings**
  - Emergency:  Disable  Enable
  - Assign Emergency to Log Key (long press):  Disable  Enable
  - Emer SW ON Timer: 5 seconds
  - Emer SW OFF:  Disable  Enable
  - Emer SW OFF Timer: 2 seconds
  - Emergency Alert Tone:  Disable  Enable
  - Emergency Alert Tone Volume: 32
  - Call Type: All
  - Cancel on Reply:  Disable  Enable
  - Cancel by Time:  Disable  Enable
  - Time: 60 seconds

37 Emergency Alert Tone .....

Emergency: Enable

Select whether or not to sound an alarm when an Emergency call is sent. When this item is set to “Disable,” “Emergency” is not displayed on the screen, and IP100H sends the Emergency call. (Default: Enable)

When “Enable” is selected, set the [Emergency Alert Tone Volume] (audio level) of the alarm to between 0 and 32. (Default: 32)

38 Call type .....

Emergency: Enable

Select the call type of Emergency call from Individual, Group, All, or Telephone. (Default: All)  
If you select “Individual” or “Group,” enter the 4 digit Destination ID. If you select “Telephone,” enter a Destination Phone Number of up to 31 characters (0–9, #, and \*).

39 Cancel on Reply .....

Emergency: Enable

Select whether or not to cancel the Emergency call when any RX code is received. (Default: Enable)

40 Cancel by Time .....

Select whether or not to cancel the Emergency call after the set period of time has passed. (Default: Disable)  
If you select “Enable,” enter a period of time to between 1 and 255 seconds. (Default: 60 (seconds))

Transceiver Settings screen

Transceiver Controller > Transceiver Settings > Transceiver Settings

■ Transceiver Settings

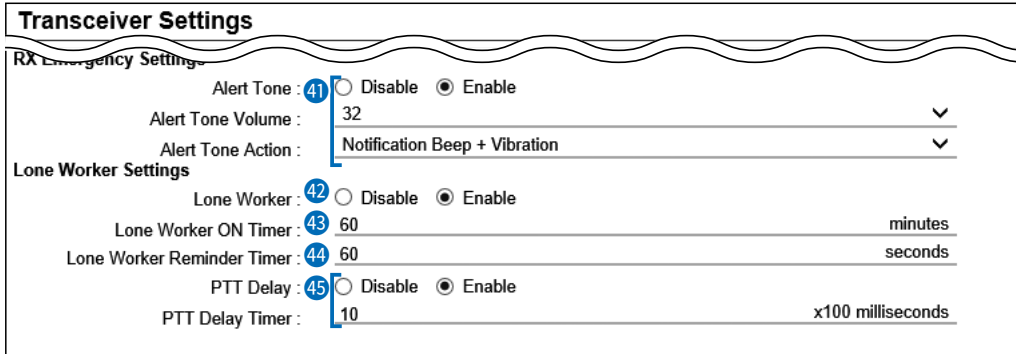

(This is an example of when the [Lone Worker] (42) is set to “Enable.”)

41 Alert Tone.....  
Emergency: Enable

Select whether or not to cancel an Emergency call after the set period of time has passed. (Default: Enable)  
If you select “Enable,” set the Volume (audio level) to between 0 and 32, and select the action. (Default: 32, Notification Beep+Vibration)  
① In the [Alert Tone Action], select “Notification Beep,” “Vibration,” or “Notification Beep + Vibration” to activate when an Emergency call is received.

42 Lone Worker .....  
Emergency: Enable

If the Lone Worker function is activated, the Emergency function is automatically turned ON after the set period of time has passed with no operation. (Default: Disable)

43 Lone Worker ON Timer.....  
Lone Worker: Enable

Enter the period of time for starting the Lone Worker function. (Default: 60 (minutes))  
• Range: 1 ~ 255 (minutes) in 1 second steps  
① When the IP100H is operated within the period of time in this item, the times for [Lone Worker ON Timer] (43) and [Lone Worker Reminder Timer] (44) are reset.

Transceiver Settings screen

Transceiver Controller > Transceiver Settings > Transceiver Settings

■ Transceiver Settings

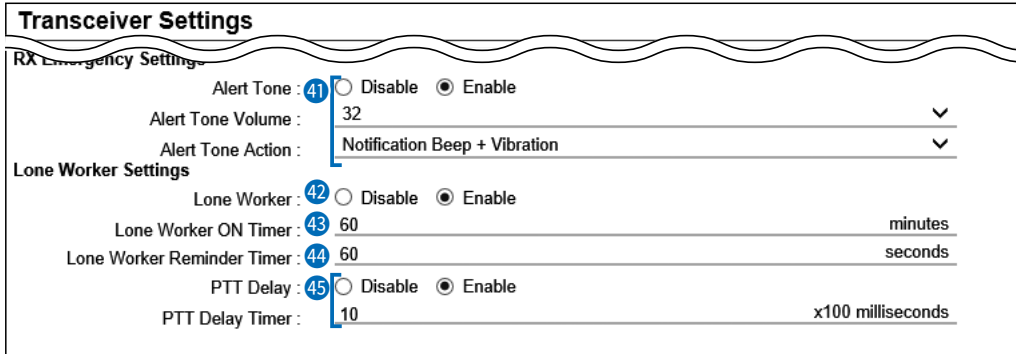

(This is an example of when the [Lone Worker] (42) is set to “Enable.”)

44 Lone Worker Reminder Timer  
 Lone Worker: Enable

Enter the period of time to start the Emergency call transmission after the period of time that is set in [Lone Worker ON Timer] (43) has passed. (Default: 60 (seconds))  
 When the transceiver is not operated after the period of time has passed, the Emergency call automatically starts.

- Range: 1 ~ 255 (seconds) in 1 second steps

① When the transceiver is operated by the [Emergency] function activation, [Lone Worker ON Timer] and [Lone Worker Reminder Timer] are reset.  
 ① When the [Lone Worker Reminder Timer] is activated, beeps sound every 2 seconds until the timer is reset.

45 PTT Delay.....  
 Lone Worker: Enable

Enter the period of time for the delay time to transmit by pushing [PTT] while [Lone Worker On Timer] and [Lone Worker Reminder Timer] are activated. (Default: Enable, 10)

- Range: 1 ~ 255 (×100 milliseconds)

① If this item is set to a longer period of time, you can reset [Lone Worker On Timer] and [Lone Worker Reminder Timer] by momentary pushing [PTT] without transmitting.  
 ① Hold down [PTT] for more than the set period of time in this item to transmit.

**NOTE:**

The RoIP Gateway should not be used when high reliability is necessary. The communication cannot be made, depending on the environment around the RoIP Gateway, such as the consumption of a battery, the signal environment, or the access point or network status. Use the [Emergency] and [Lone Worker] functions as a supplementary function.



Transceiver Settings screen

Transceiver Controller > Transceiver Settings > Transceiver Settings

■ Transceiver Settings

46 Buffer Type .....

Select the buffer type to control any interrupted sound. (Default: Dynamic)

• **Static**

The buffer time is set [Receive Buffer Size]. Set the buffer time to between 20 and 500 milliseconds to keep the audio from breaking up. A shorter value improves the delay, but it may frequently break the audio signal.

• **Dynamic**

The buffer time changes according to the audio fluctuation.

Transceiver Settings screen

Transceiver Controller > Transceiver Settings > Transceiver Settings

■ Transceiver Settings

**47 TOS type** ..... Select the TOS (Type-Of Service) format. (Default: TOS)

- **Not used:** The TOS function is disabled.
- **TOS:** Sends the 8 bit VoIP packets to the TOS field in the IP header using the TOS format. Sets to between 1 (lowest) and 3 bits (Priority level) or 4 and 7 (highest) bits (Type of Service), based on the RFC1349. The 1 bit remaining is not used, and is fixed as 0.
- **Diffserv:** Sends the 8 bit VoIP packets to the TOS field in the IP header using the Diffserv (Differentiated Service) format. Sets to between 1 and 6 bits (DSCP). The 2 bits remaining are not used, and are fixed as 0.

Transceiver Settings screen

Transceiver Controller > Transceiver Settings > Transceiver Settings

■ Transceiver Settings

**Transceiver Settings**

---

**V/RoIP Settings**

Buffering Type : 46  Static  Dynamic

TOS Type : 47 TOS ▼

Media (RTP) Priority Level : 48 7

Media (RTP) Service Type : 0

Media (RTP) (HEX) : E0

**Antenna**

Antenna Type : 49 Transceiver's Setting ▼

**IP Address**

IP Address Settings : 50 Transceiver's Setting ▼

48 Media (RTP) .....

Select the Priority level and Service type of the sent VoIP packets.  
 ⓘ The item is not displayed when [TOS Type] (47) is set to "Not used."

- **Media (RTP) Priority Level**  
 Set the TOS priority level to between 0 (lowest) and 7 (highest). (Default: 7)
- **Media (RTP) Service Type**  
 Set the TOS service type code to between 0 and 15. (Default: 0)
- **Media (RTP) DSCP**  
 Set the DSCP (Differentiated Services Code Point) code to between 0 and 63. (Default: 56)  
 - This item is displayed when the [TOS Type] (47) is set to "Diffserv."

**V/RoIP Settings**

Buffering Type :  Static  Dynamic

TOS Type : Diffserv

Media (RTP) DSCP : 56

Media (RTP) (HEX) : E0

Transceiver Settings screen

Transceiver Controller > Transceiver Settings > Transceiver Settings

■ Transceiver Settings

49 Antenna Type .....

Select the antenna that the IP100H will use. (Default: Transceiver's Setting)

• **Transceiver's Setting**

Uses the last antenna set by the CS-IP100H or the RoIP Gateway.

• **Internal Antenna**

Uses the internal antenna when you want to:

- Reduce the communication range.
- Limit the communication area and improve security.
- Reduce electrical interference among Wireless LAN transceivers.
- Control the communication speed in an environment where some access points are installed in a comparatively small area.

• **External Antenna**

Uses the external antenna. The external antenna extends the communication range.

50 IP Address Settings .....

Select the IP100H's IP settings. (Default: Transceiver's Setting)

• **Transceiver's Setting**

Uses the last IP setting set by the CS-IP100H or the RoIP Gateway.

• **DHCP Client**

Selects the DHCP Client when the IP address is automatically obtained by a DHCP server.

IP Address	
IP Address Settings :	DHCP Client
Primary DNS Server :	_____
Secondary DNS Server :	_____

① If necessary, enter the [Primary DNS Server] or [Secondary DNS Server] settings.

Transceiver Settings screen

Transceiver Controller > Transceiver Settings > Transceiver Settings

■ Transceiver Settings

**Transceiver Settings**

---

**V/RoIP Settings**

Buffering Type : 46  Static  Dynamic

TOS Type : 47 TOS ▼

Media (RTP) Priority Level : 48 7

Media (RTP) Service Type : 0

Media (RTP) (HEX) : E0

**Antenna**

Antenna Type : 49 Transceiver's Setting ▼

**IP Address**

IP Address Settings : 50 Transceiver's Setting ▼

50 IP Address Settings .....

• **Static IP**

Selects the Static IP address, if it is specified according to your network environment.

**IP Address**

IP Address Settings : Static IP

IP Address : \_\_\_\_\_

Subnet Mask : \_\_\_\_\_

Default Gateway : \_\_\_\_\_

Primary DNS Server : \_\_\_\_\_

Secondary DNS Server : \_\_\_\_\_

- ① Enter the default gateway address, if your network connects to a different network.
- ① If necessary, enter the [Primary DNS Server] or [Secondary DNS Server] settings.

## Transceiver Settings screen

Transceiver Controller > Transceiver Settings > Transceiver Settings

### ■ Transceiver Settings

#### 51 Provisioning Server .....

Enter an IP address or Host name of the Provisioning Server for the IP100H, of up to 63 characters.

① When the RoIP Gateway is used as its Provisioning Server, this entry is not necessary.

#### 52 Accept Reboot Command from Other than the Master Controller

Select whether or not the IP100Hs can be rebooted by the other than the specified Provisioning server (51). (Default: Disable)

① The RoIP Gateway and IP100C are compatible with this function. (As of May, 2019)

#### 53 SNTP Server .....

Enter the IP address of the device that is specified as the SNTP server for the IP100H.

① When the RoIP Gateway is used as its SNTP Server, this entry is not necessary.

#### 54 Automatic Firmware Updating at Power ON .....

Select whether or not the IP100H will use the Automatic Update function. (Default: Enable (with Automatic Reboot))

##### • Disable

Disables the automatic firmware updating when the IP100H is turned ON.

##### • Enable (without Automatic Reboot)

When this setting is set to “Enable (without Automatic Reboot),” the IP100H works as follows.

1. The IP100H confirms the latest firmware in the RoIP Gateway when it is turned ON.
2. The IP100H automatically downloads the firmware if it needs to be updated.
3. The IP100H will be updated when it is turned ON again.

##### • Enable (with Automatic Reboot)

When this setting is set to “Enable (with Automatic Reboot),” the IP100H works as follows.

1. The IP100H confirms the latest firmware in the RoIP Gateway when it is turned ON.
2. The IP100H automatically downloads the firmware if it needs to be updated.
3. The IP100H is updated automatically, and then it is rebooted.

① You can check the firmware version of the IP100H on the [TOP] menu.

Transceiver Settings screen

Transceiver Controller > Transceiver Settings > Transceiver Settings

■ Transceiver Settings

- 55 Firmware Server**.....

Enter an IP Address or Host name of the Firmware Server for the IP100H, of up to 63 characters.

① When the RoIP Gateway is used as its Firmware Server, this entry is not necessary.
- 56 SYSLOG Host IP Address**

Enter the SYSLOG host's address.

① The host device must have the SYSLOG server function.
- 57 SYSLOG Severity** .....

Select the log information to send to the SYSLOG host. The SYSLOG host is sent to another host that is set in the [SYSLOG Host IP Address] (56). (Default:  DEBUG  INFO  NOTICE)

① Enter a check mark to send the log entries.
- 58 Read/Write Password** .....

Enter a password of up to 16 characters. The password is used when reading from, or writing to the IP100H, or updating the firmware using the CS-IP100H\*.

\* CS-IP100H is the cloning software for the IP100H, and can be downloaded from the Icom website.
- 59 <Apply>** .....

Click to apply the entries.

① Some parts of the entries are displayed in [Transceiver Setting List], such as the Transceiver Model, Name, Unit ID, Use ID List, Area Call, Message, Status, and Option Key.
- 60 <Reset>** .....

Click to reset the settings.

① You cannot reset after clicking <Apply>.

Transceiver Settings screen

Transceiver Controller > Transceiver Settings > Transceiver Settings

### Copy Transceiver Settings

The individual settings in the [Transceiver Settings] screen can be copied to another IP100H.

① IP address settings are not copied.

- ① **Check Box** ..... Enter a check mark to [All] or the [Unit ID] that you want to copy the settings to.
- ② **<Apply>** ..... Click to apply the entries.  
 ① The entries in the [Transceiver Settings] of the Source Transceiver are copied to the transceiver settings that have a check mark in [Check Box] (①).
- ③ **<Reset>** ..... Click to reset the settings.  
 ① You cannot reset, after clicking <Apply>

Transceiver Controller > Transceiver Settings > Transceiver Settings

### Transceiver Setting List

Display the list of the registered IP100Hs.

① When verifying the contents, or editing the settings, select the individual number in the Unit ID.

Transceiver Setting List							
Transceiver Model	Name	Unit ID	Use ID List	Area Call	Message	Status	Option Key
IP100H	Sales1	0101	Enable	Enable	Enable	Enable	No Function
IP100H	Sales2	0102	Enable	Enable	Enable	Enable	No Function
IP100H	Sales3	0103	Enable	Enable	Enable	Enable	No Function



## Wireless LAN screen

Transceiver Controller > Common Settings > Wireless LAN

### Wireless LAN

Register wireless LAN settings that are commonly used by the IP100Hs. You can individually set the common settings to each registered group in [Profile] on the [Common Settings] screen. If any setting in this screen has been changed, you must reboot the IP100Hs.

- 1 No.** ..... Select a group number between 1 and 20 to assign to the IP100Hs. Up to 20 groups can be registered. (Default: 1)
- 2 Name** ..... Enter a Group name of up to 31 characters. (Default: Blank)
- 3 Scan Mode** ..... Select the frequency band that the IP100H uses. (Default:  11g,  11a ( W52,  W53,  W56))  
 Selecting “11g” includes “11b.”  
 ⓘ Access points that comply with the wireless LAN standards can be used with the IP100H.

Wireless LAN screen

Transceiver Controller > Common Settings > Wireless LAN

■ Wireless LAN

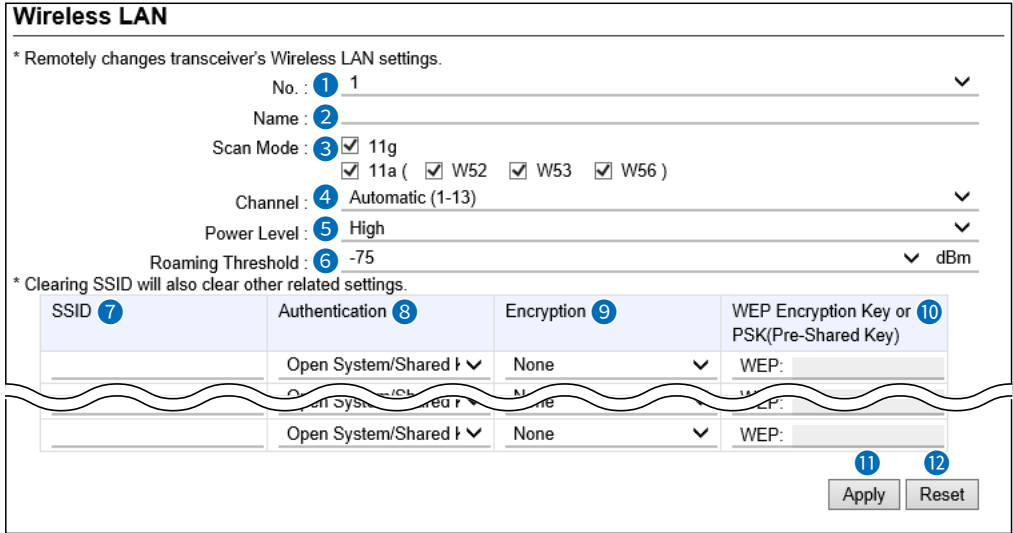

4 Channel .....

Select the channel that you want to scan when the IP100H uses 2.4 GHz (11g). (Default: Automatic (1-13))

① When you specify a channel, select "Static" in the [Channel], and specify a channel that you use in [Static Channel].



5 Power Level.....

Set the IP100H transmit power level to High, Middle or Low. (Default: High)

① When "High" is set, the transmission distance of the IP100H is maximum. Or when setting to a lower level, the distance will be reduced.

- ① Power Level is set to a lower level when you want to:
- Reduce the communication range.
  - Limit the communication area and improve security.
  - Reduce electrical interference among Wireless LAN transceivers.
  - Control the communication speed in an environment where some access points are installed in a comparatively small area.

## Wireless LAN screen

Transceiver Controller > Common Settings > Wireless LAN

### ■ Wireless LAN

#### 6 Roaming Threshold .....

Set the received signal strength level when the IP100H starts roaming. The settable level is between  $-1$  and  $-100$  dBm. (Default:  $-75$  (dBm))  
 ⓘ When setting to a high level (example:  $-50$  dBm), it becomes easy to start roaming. Or when setting to a low level (example:  $-90$  dBm), it becomes difficult to start roaming.

#### 7 SSID .....

Enter an SSID that is the same as that of the wireless access point. Enter up to 32 characters, using numbers, symbols and letters (both lower and upper case).  
 Be careful of the difference between lower and upper case letters.

#### ⓘ Information

- Up to 10 SSIDs can be registered.
- The SSID is used to separate the wireless network groups. You cannot connect to different SSID groups.
- If two or more wireless access points exist in the same area, each wireless network group is identified by the SSID (wireless network name).
- If you register two or more SSIDs, the IP100H connects to the SSID which has the strongest radio signal.
- For any other wireless device, this may be called ESSID.
- The setting data before version 2.04 automatically moves to the top of the SSID setting.

#### NOTE:

You cannot apply the Wireless LAN settings when:

- The setting for the same "SSID" (6) and "Encryption" (7) as that you entered already exists.
- The top of the SSID setting overlaps with other Wireless LAN (a different value is set in "No." (1)) settings.

Wireless LAN screen

Transceiver Controller > Common Settings > Wireless LAN

■ Wireless LAN

⑧ Authentication .....

Select the authentication method that is the same as that of the wireless access point. (Default: Open System/Shared Key)  
 ① Be sure to verify the Access point setting, because the terminals and access points cannot communicate using different authentication methods.

**About authentication methods**

- **Open System/Shared Key**  
 When accessing a wireless access point, “Open System” and “Shared Key” are automatically recognized. If the Encryption key matches the key in the Access point, they can communicate.
- **Open System**  
 When accessing a wireless access point, confirming the encryption is not necessary.
- **WPA-PSK/WPA2-PSK**  
 The “WPA-PSK” and “WPA2-PSK” authentications are automatically recognized.

**The combination of the Authentication and Encryption**

	Open System	Open System/ Shared Key	WPA-PSK WPA2-PSK
None	✓	✓	-
WEP RC4	✓	✓	-
TKIP/AES	-	-	✓

Wireless LAN screen

Transceiver Controller > Common Settings > Wireless LAN

■ Wireless LAN

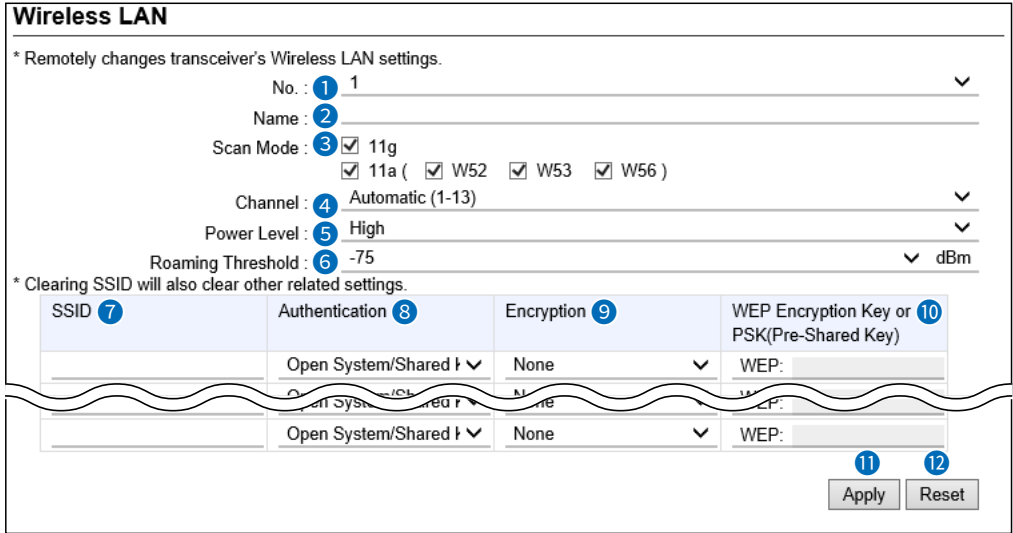

9 Encryption .....

Select the encryption type that is the same as that of the wireless access point. (Default: None)  
 ① Be sure to verify the access point setting, because the terminals and access points cannot communicate using different encryption.

**About the encryption types**

• **None**

No data is encrypted.

① This option can be selected when [Authentication] (8) is set to "Open System" or "Open System/Shared Key."

• **WEP RC4**

It is an encryption type that can communicate when the encryption keys match.

① You can set the encryption key length to between 64 (40) and 128 (104) bits.

① You can select this option when [Authentication] (8) is set to "Open System" or "Open System/Shared Key."

• **TKIP/AES**

Either the "TKIP" or "AES" encryptions are automatically recognized when connecting to a wireless access point.

① You can select this option when [Authentication] (8) is set to "WPA-PSK/WPA2-PSK."

## Wireless LAN screen

Transceiver Controller > Common Settings > Wireless LAN

### ■ Wireless LAN

#### ⑩ WEP Encryption Key or PSK (Pre-Shared Key) .....

##### • WEP Encryption Key

Enter the encryption key that is the same as that of the wireless access point.

Authentication	Encryption	WEP Encryption Key or PSK(Pre-Shared Key)
Open System/Shared Key	WEP RC4 64 (40)	WEP: 0000000000

- ① This option can be selected when [Authentication] (8) is set to “Open System” or “Open System/Shared Key.”
- ① Enter hexadecimal numbers with numbers (0 to 9) and letters (A to F). Or enter ASCII characters. The key length is same as the displayed digits, 10 or 26 using hexadecimal numbers, or half of the displayed digits, 5 or 13 characters using ASCII characters.

##### • PSK (Pre-Shared Key)

Enter the pre-shared key that is the same as that of the wireless access point.

Authentication	Encryption	WEP Encryption Key or PSK(Pre-Shared Key)
WPA-PSK/WPA2-PSK	TKIP/AES	PSK: 00000000

- ① This option can be selected when [Authentication] (8) is set to “WPA-PSK/WPA2-PSK.”
- ① Enter hexadecimal numbers with numbers (0 to 9) and letters (A to F). Or enter ASCII characters. The key length is 64 digits using hexadecimal number, or 8 to 63 characters using ASCII characters.

Wireless LAN screen

Transceiver Controller > Common Settings > Wireless LAN

■ Wireless LAN

**Wireless LAN**

\* Remotely changes transceiver's Wireless LAN settings.

No. : ① 1

Name : ②

Scan Mode : ③  11g  
 11a (  W52  W53  W56 )

Channel : ④ Automatic (1-13)

Power Level : ⑤ High

Roaming Threshold : ⑥ -75 dBm

\* Clearing SSID will also clear other related settings.

SSID ⑦	Authentication ⑧	Encryption ⑨	WEP Encryption Key or PSK(Pre-Shared Key) ⑩
	Open System/Shared t	None	WEP:
	Open System/Shared t	None	WEP:
	Open System/Shared t	None	WEP:

⑪ Apply    ⑫ Reset

- ⑪ <Apply> ..... Click to apply the entries.  
 ⓘ The entries are displayed in [List of Wireless LAN Entries].
- ⑫ <Reset> ..... Click to reset the settings.  
 ⓘ You cannot reset after clicking <Apply>.

Wireless LAN screen

Transceiver Controller > Common Settings > Wireless LAN

### List of Wireless LAN Entries

Display the list of the wireless LAN settings.

List of Wireless LAN Entries				
No.	Name	SSID	1	2
1	Sales	.....	Edit	Delete

Delete All 3

- 1 <Edit> ..... Click to edit the entries in [Wireless LAN].
- 2 <Delete> ..... Click to delete the selected entry.  
① After clicking <Delete>, the entry cannot be recalled.
- 3 <Delete All> ..... Click to delete all the entries.  
① After clicking <Delete All>, the entries cannot be recalled.



## ID List screen

Transceiver Controller > Common Settings > ID List

### ■ ID List Common Settings

Select an ID list that the IP100Hs will use.

- ① You can individually specify an ID list to the groups that the IP100Hs belong to in [Profile] on the [Common Settings] screen.
- ① If any entries on this screen have been changed, you must reboot the IP100H.

ID List Common Settings	
ID List Common Setting Number :	1 (0 Entries) <span style="float: right;">▼</span>
<small>* If you change this item, the screen automatically updates to the selected list.</small>	

#### ID List Common Setting Number

Select the group number between 1 and 50, and then enter IDs that the IP100Hs will use.

- ① When the group name or IDs are registered in the group, they are displayed as shown below.

ID List Common Setting Number :	1 (Sales / 5 Entries)
<small>* If you change this item, the screen automatically updates to the selected list.</small>	

Transceiver Controller > Common Settings > ID List

### ■ ID List Advanced Settings

Enter the group name that is selected in [ID List Common Settings].

ID List Advanced Settings	
Name : ①	<span style="margin-right: 10px;">② Apply</span> <span>③ Reset</span>

#### ① Name .....

Enter a group name of up to 31 characters.  
 The group is selected in [ID List Common Setting] on the [ID List] screen.  
 When the group is selected on the [ID List] and [Profile] screens, the group name is displayed.

#### ② <Apply> .....

Click to apply the entries.

#### ③ <Reset> .....

Click to reset the settings.  
 ① You cannot reset after clicking <Apply>.

ID List screen

Transceiver Controller > Common Settings > ID List

## ■ Save or Write the ID List Setting

You can save an ID list file on your PC, or load an ID list file to the RoIP Gateway.

① If any IP100H settings have been changed, you must reboot it.

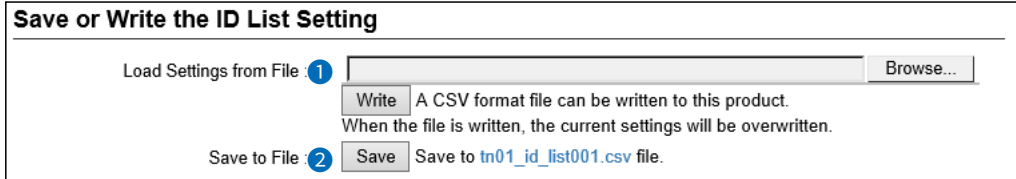

① This is an example of when Group 1 is selected in [ID List Common Setting].  
When a name is registered in a group, the name is also displayed.

### ① Load Settings from File ...

Load an ID list file, which is saved on [Save to File] (②), to the RoIP Gateway.

Click <Browse> to select the file to load.

Select the target file on screen, and click <Open>. The selected file is displayed in [Load Settings from File].

Click <Write> after selecting the target file. Then, the selected file is loaded to [ID List Entries].

① When the file is loaded, the previous data in [ID List Entries] is deleted.

① If you select the file that is saved on the [Settings Restore] screen in the [Management] menu, the setting is overwritten.

### ② Save to File .....

Save an ID list file, which is listed in [ID List Entries], to your PC.

Click <Save>, and then <Save> on the box to save an ID list file (a CSV file) to your PC.

① A file name varies, depending on the group number in [ID List Common Settings]. For example, the file name becomes "tn01\_id\_list001.csv" when Group 1 of Tenant 1 is selected.

## ID List screen

Transceiver Controller > Common Settings > ID List

### ■ Save or Write the ID List Setting

#### ○ About the rules of a CSV file for the ID list

Icom is not responsible for writing another ID list file except a saved ID list file or an ID list file that is edited, as shown below.

#### Format of a CSV file for the ID list file

	A	B	C	D	E	F
1	#	VE-PG4	ID List Setting	config file		
2	#	Firm Ver. █				
3	#	File Ver. █				
4	#Group	Sales				
5	#No.	Name	Call Type (indi=Individual/group=Group/tel=Telephone)	Destination ID (Individual/Group)	Destination ID (Telephone)	Talkgroup
6	1	Sales 1	indi	1		0
7	2	Sales 2	indi	2		0
8	3	Sales 3	indi	3		0
9						

Column	Title	Description
A	Index	Group name: Up to 31 characters, No.: 1 ~ 50 Do not duplicate the number
B	Name	Up to 32 characters
C	Call Type	indi: Individual, group: Group, tel: Telephone
D	Destination ID (Individual/Group)	Up to 4 characters
E	Destination ID (Telephone)	Up to 31 digits using numbers and symbols (#, *)
F	Talkgroup	0: Disable, 1: Enable

ID List screen

Transceiver Controller > Common Settings > ID List

**ID List**

Enter target IDs in the group that is selected in [ID List Common Settings].

① You can enter up to 50 target IDs in each group.

① This is an example of when “Enter individually” is selected in the “Add Type” (1).  
When a name is registered in a group, the name is also displayed.

**1 Add Type** .....

Select [Enter Individually] or [Select From List] in the [Add Type].  
When [Select From List] is selected, the Destination IDs that are registered on the [Transceiver Registration] screen or [Destination Settings] screen, are displayed.

① By selecting [All], you can select or cancel all entries in the list.

① When [Select From List] is selected, you can enter a name of up to 32 characters.

**ID List(Sales)**

Add Type :  Enter Individually  Select From List

<input type="checkbox"/> All	Name	Call Type	Destination ID/Phone Number
<input type="checkbox"/>	Sales1	Individual	0101
<input type="checkbox"/>	Sales2	Individual	0102
<input type="checkbox"/>	Sales3	Individual	0103
<input type="checkbox"/>	IP100FS	Individual	0050
<input type="checkbox"/>	Group0001	Group	0001

**2 No.** .....

Select a number to register the destination.  
Up to 50 destinations can be registered to a group.

**3 Name** .....

Enter a destination name of up to 32 characters.

ID List screen

Transceiver Controller > Common Settings > ID List

■ ID List

① This is an example of when “Enter individually” is selected in the “Add Type” (1).  
When a name is registered in a group, the name is also displayed.

- 4 **Call Type** ..... Select the Call type.  
Options: Individual, Group, Talkgroup, or Telephone
- 5 **Destination ID** ..... Enter a 4 digit target individual ID, group ID or talkgroup ID.  
When “Telephone” is selected as [Call Type] (4), enter a target phone number of up to 31 digits using numbers and symbols (#, \*).
- 6 **<Apply>** ..... Click to apply the entries.  
① The entries are displayed in [ID List Entries].
- 7 **<Reset>** ..... Click to reset the settings.  
① You cannot reset after clicking <Apply>.

ID List screen

Transceiver Controller > Common Settings > ID List

## ■ ID List Entries

Displays the list of entered Group Calls.

ID List Entries(Sales)				
No.	Name	Call Type	Destination ID/Phone Number	
1	Individual 1	Individual	0101	<div style="display: flex; justify-content: space-around;"> <span>① Edit</span> <span>② Delete</span> </div>
2	Individual 2	Individual	0102	<div style="display: flex; justify-content: space-around;"> <span>Edit</span> <span>Delete</span> </div>
	UT136-32	Telep...	32	<div style="display: flex; justify-content: space-around;"> <span>Edit</span> <span>Delete</span> </div>
				<div style="display: flex; justify-content: flex-end;"> <span>③ Delete All</span> </div>

① This is an example of when Group 1 is selected in [ID List Common Settings].  
When a name is registered in a group, the name is also displayed.

- ① **<Edit>** ..... Click to edit the entries in [ID List].
- ② **<Delete>** ..... Click to delete the selected entry.  
① After clicking <Delete>, the entry cannot be recalled.
- ③ **<Delete All>** ..... Click to delete all the entries.  
① After clicking <Delete All>, the entries cannot be recalled.

## Messages screen

Transceiver Controller > Common Settings > Messages

### Message Group

Select to register a message that the IP100Hs will use.

① You can individually specify the message group that the IP100Hs belong to in “Message List” in [Profile] on the Profile screen.

(Transceiver Controller > Common Settings > Profile > Profile > Message List)

① If any entries on this screen have been changed, you must reboot the IP100H.

Message Group	
Message Group Number :	1 (0 Messages) <span style="float: right;">▼</span>
* If you change this item, the screen automatically updates to the selected list.	

**Message Group Number** .....

Select a group number between 1 and 50, and then enter the messages that the IP100Hs will use.

① When the group name or messages are registered in the group, they are displayed as shown below.

Message Group	
Message Group Number :	1 (Sales / 10 Messages)
* If you change this item, the screen automatically updates to the selected list.	

Transceiver Controller > Common Settings > Messages

### Message Group Detail

Enter the group name that is selected in [Message Group].

Message Group Detail	
Name :	<input type="text"/> <span style="float: right;"> <span style="border: 1px solid gray; padding: 2px 5px;">Apply</span> <span style="border: 1px solid gray; padding: 2px 5px;">Reset</span> </span>

① **Name** .....

Enter a group name of up to 31 characters.

The group is selected in [Message Group] on the [Message] screen.

① When the group is selected on the [Messages] screen and [Profile] screen, the group name is displayed.

② **<Apply>** .....

Click to apply the entries.

③ **<Reset>** .....

Click to reset the settings.

① You cannot reset after clicking <Apply>.

Messages screen

Transceiver Controller > Common Settings > Messages

### ■ Save or Write the Message Setting

You can save a message file on your PC, or load a message file to the RoIP Gateway.

① If any IP100H settings have been changed, you must reboot it.

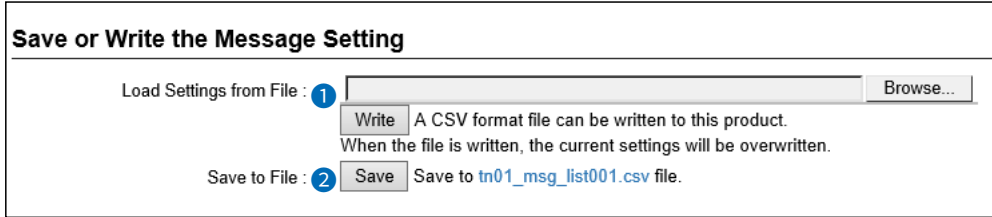

This is an example of when Group 1 is selected in [Message Group].  
When a name is registered in a group, the name is also displayed.

**① Load Settings from File ...**

Load a message file, which is saved on “Save to File” (②), to the RoIP Gateway.

Click <Browse> to select the file to load.

Select the target file on screen, and click <Open>. The selected file is displayed in “Load Settings from File”. Click <Write> after selecting the target file. Then, the selected file is loaded to [Messages].

① The previous data in [Messages] is overwritten the loaded data.

① If you select the file that is saved on the Settings Restore screen in the [Management] menu, the setting is overwritten.

**② Save to File .....**

Save a message file, which is listed in the [Message], to your PC. Click <Save>, and then <Save> on the box to save a message file (a CSV file) to your PC.

① The file name varies, depending on the group number in [Message Group]. For example, the file name becomes “tn01\_msg\_list001.csv” when Group 1 of Tenant 1 is selected.



## Messages screen

Transceiver Controller > Common Settings > Messages

### ■ Save or Write the Message Setting

#### ○ About the rules of a CSV file for the message file

Icom is not responsible for writing another message file except a saved message file or a message file that is edited as shown below.

#### Format of a CSV file for the message file

	A	B	C	D
1	#	VE-PG4	Message Settings	Message file
2	#	Firm Ver. █		
3	#	File Ver. █		
4	#Group Name	Sales		
5	#Index	Message		
6		1 Gather immediately.		
7		2 A message was sent.		
8		3 Check the message.		
9		4 Is it no problem?		
10		5 Give me a reply.		
11		6 Give me a reply immediately.		
12		7 Please disperse there.		
13		8 Back to the office ASAP.		
14		9 The parcel arrived.		
15		10 The work finished.		

Column	Title	Description
A	Index	Group name: Up to 31 characters, No.: 1 ~ 10 Do not duplicate the number
B	Message	Up to 32 characters

Messages screen

Transceiver Controller > Common Settings > Messages

### ■ Message List

Enter messages in the group that is selected in [Message Group].

You can transmit fixed message of up to 32 characters.

① You can enter up to 10 messages in each message group.

No.	Fixed Message
1	<u>G</u> ather immediately.
2	<u>A</u> message was sent.
3	<u>C</u> heck the message.
4	<u>I</u> s it no problem?
5	<u>G</u> ive me a reply.
6	<u>G</u> ive me a reply immediately.
7	<u>P</u> lease disperse there.
8	<u>B</u> ack to the office ASAP.
9	<u>T</u> he parcel arrived.
10	<u>T</u> he work finished.

When a name is registered in a group, the name is also displayed.

① <Apply> ..... Click to apply the entries.

② <Reset> ..... Click to reset the settings.  
① You cannot reset after clicking <Apply>.

## Status screen

Transceiver Controller > Common Settings > Status

### ■ Status Settings

Select to register a status that the IP100Hs use.

- ① You can program statuses of up to 32 characters. You can enter up to 10 statuses.
- ① If any entries on this screen have been changed, you must reboot the IP100H.

**Status Settings**

① <input checked="" type="checkbox"/> All	Status No.	Status Name
<input checked="" type="checkbox"/>	1	Meeting
<input checked="" type="checkbox"/>	2	Away from the desk
<input checked="" type="checkbox"/>	3	At lunch
<input checked="" type="checkbox"/>	4	Under a round
<input checked="" type="checkbox"/>	5	At the desk
<input checked="" type="checkbox"/>	6	Working
<input checked="" type="checkbox"/>	7	Waiting
<input checked="" type="checkbox"/>	8	Under preparation
<input checked="" type="checkbox"/>	9	In progress
<input checked="" type="checkbox"/>	10	Under a break

② Apply
③ Reset

**① Check Box** .....

Click a Check Box to display a status name on the IP100H.  
 ① When the box is not checked, the status name is not displayed on the IP100H, even if you entered it.  
 When the status name is not entered, the status number is displayed on the IP100H only if the box is checked.  
 ① You can check or uncheck them all at once by clicking [All].

**② <Apply>** .....

Click to apply the entries.

**③ <Reset>** .....

Click to reset the settings.  
 ① You cannot reset after clicking <Apply>.

## Profile screen

Transceiver Controller > Common Settings > Profile

### ■ Profile List

Display the entries that are entered in [Common Settings].

No.	Name	Wireless LAN	ID List Number	Common Message Group	2	3
1	Sales group	Transceiver's Setting	1 (Sales)	1 (Sales)	Edit	Delete
2						▼
<input type="button" value="Add"/> 1						
<input type="button" value="Delete All"/> 4						

- 1 <Add> ..... Click to add an new profile.
- 2 <Edit> ..... Click to edit the entries in [Profile].
- 3 <Delete> ..... Click to delete the selected entry.  
 ⓘ After clicking <Delete>, the entry cannot be recalled.
- 4 <Delete All> ..... Click to delete all the entries.  
 ⓘ After clicking <Delete All>, the entries cannot be recalled.

Profile screen

Transceiver Controller > Common Settings > Profile

## Profile

Individually assign an ID list, message list or receive notification tone to the group that the IP100H belongs to.

① After the setting is completed, you must reboot the IP100H.

Profile	
No. :	① 1 (Sales group) <span style="float:right">▼</span> <small>* If you change this item, the screen automatically updates to the selected profile.</small>
Name :	② Sales group
Wireless LAN	Wireless LAN : ③ Transceiver's Setting <span style="float:right">▼</span>
Common Settings	ID List : ④ 1 (Sales) <span style="float:right">▼</span>
	Message List : ⑤ 1 (Sales) <span style="float:right">▼</span>

- ① **No.** ..... Select a profile between 1 and 50, to assign to the group that IP100H belongs to.
  
- ② **Name** ..... Enter a profile name of up to 31 characters.  
The profile name is displayed in [Profile List] on the [Profile] screen.
  
- ③ **Wireless LAN** ..... Select the wireless LAN setting that is commonly used by the IP100Hs in the group. (Default: Transceiver's Setting)
  - **Transceiver's Setting**  
Uses the last wireless LAN setting that was set by the CS-IP100H or the RoIP Gateway.
  - **1 (Name) to 20 (Name)**  
Select a number that was entered on the [Wireless LAN] screen.
  
- ④ **ID List** ..... Select an ID list that is commonly used by the IP100Hs in the group. (Default: 1)
  - ① Select an ID number that is registered on the [ID list] screen.
  
- ⑤ **Message List** ..... Select a Message list that is commonly used by the IP100Hs in the group. (Default: 1)
  - ① Select a message number that is registered in [Messages].

## Profile screen

Transceiver Controller > Common Settings > Profile

### Profile

Profile	
Page List : (res)	
<b>Registration</b>	
Controller IP Address Notify :	6
Registration Interval :	7 60 seconds
Registration Retry Interval (If failed) :	8 10 seconds
Number of Registration Retries (If failed) :	9 2
Expire Time :	10 180 seconds
<b>Calling Notice Tone</b>	
Individual Call :	11 Tone 1
Group Call :	Tone 1
All Call :	Tone 1
Telephone :	Tone 1

#### 6 Controller IP Address Notify

Enter the IP address or host name of the controller that is selected as the server of IP100H.

Enter an IP address or host name of up to 63 characters.

① If you use the RoIP Gateway as a server, you must not set this item.

#### 7 Registration Interval .....

Enter the transmit interval for the registration information that the IP100Hs will use. (Default: 60)

• Range: 30 ~ 300 (seconds) in 1 second steps

① Generally use the default setting.

① When the interval period is short, and an IP100H goes out of the communication area, the IP100H registration on the RoIP Gateway can be updated earlier. Therefore, if the IP100H receives an Individual call, the RoIP Gateway can quickly reply “No response” as a Target availability check.

#### 8 Registration Retry Interval (If failed) .....

Enter a retry interval when the IP100H fails to register to the RoIP Gateway. (Default: 10)

• Range: 1 ~ 30 (seconds)

#### 9 Number of Registration Retries (If failed) .....

Enter a number of registration retries if the IP100H fails to register to the RoIP Gateway. (Default: 2)

• Range: 1 ~ 10

#### 10 Expire Time .....

The RoIP Gateway check the IP100Hs connection status in this interval. (Default: 180)

• Range: [Registration Interval] (7) setting +1 ~ 900 (seconds)

① Generally use the default setting.

① You cannot set this setting to shorter than the [Registration Interval] (7) setting.

#### 11 Calling Notice Tone .....

Select a notice tone for calling. (Default: Tone 1)

• Options: Not Use, or Tone 1 ~ Tone 8

① This tone can be individually assigned to each call type, “Individual Call,” “Group Call,” “All Call,” and “Telephone.”

Profile screen

Transceiver Controller > Common Settings > Profile

Profile

- 12 Success** ..... Select a notice tone for a successful connection. (Default: Enable)

  - ① When an Individual call, Message call, Status call or telephone call connection is successful, the Notice Tone sounds.
  - ① When [Target Availability Check] on the [Transceiver Settings] screen is set to "Disable," the Notice Tone will not sound.
  
- 13 Failure** ..... Select a notice tone for connection failure. (Default: Enable)

  - ① When an Individual call, Message call, Status call or telephone call connection fails, the Notice Tone sounds.
  - ① When [Target Availability Check] on the [Transceiver Settings] screen is set to "Disable," the Notice Tone will not sound.
  
- 14 Notification Tone** ..... Select a notice tone when a call is received. (Default: Not Use)

  - Options: Not Use, or Tone 1 ~ Tone 8
  - ① This tone can be individually assigned to each call type, "Individual Call," "Group Call," "All Call," "Telephone," and "Message."

Profile screen

Transceiver Controller > Common Settings > Profile

Profile

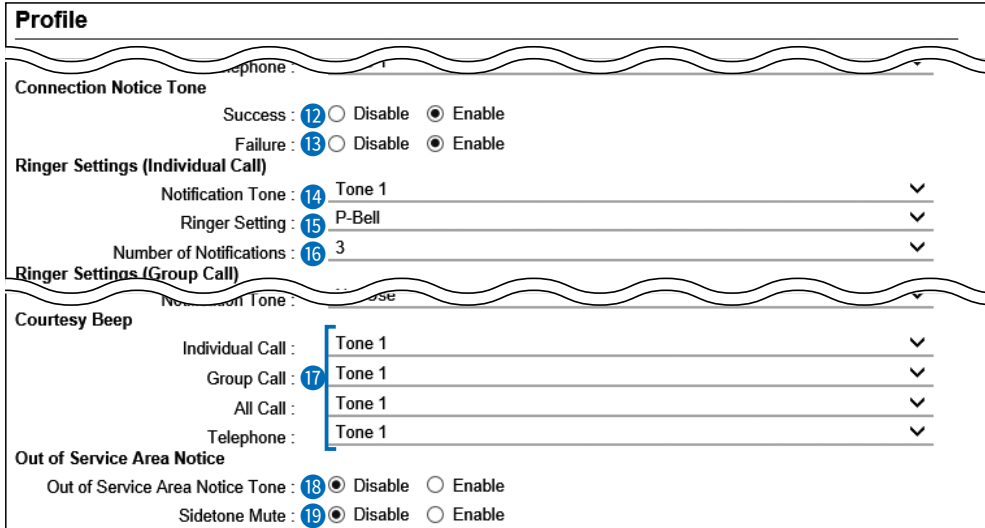

15 Ringer Setting.....

Select a notice type between “Pocket Beep” and “P-Bell.” (Default: P-Bell)

- ① This item can be selected when [Notification Tone] (14) is set to “Tone 1” to “Tone 8.”
- ① You cannot select this item for a Message call.

• **Pocket Beep**

When a specified call is received, the IP100H sounds the Notification Tone, and the notification icon blinks.

• **P-Bell**

When a specified call is received, the IP100H sounds the Notification Tone. The received audio is muted until you reply to the call.

- ① After pushing [PTT] on the IP100H, the mute will be released.

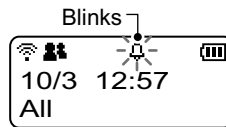

When the Pocket beep is active

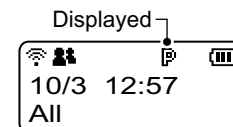

When the P-bell is ON

16 Number of Notifications ...

Select a notification number of “Continuous.” (Default: 3)

- Options: 1, 3, 10, or 20

- ① You can select this item when [Notification Tone] (14) is set to “Tone 1” to “Tone 8.”
- ① You cannot select this item for a Message call.



Profile screen

Transceiver Controller > Common Settings > Profile

Profile

**17 Courtesy Beep** ..... Select a Notice Tone when a received call is finished. (Default: Tone 1)  
 ⓘ This tone can be individually assigned to each call type, “Individual Call,” “Group Call,” “All Call,” and “Telephone.”  
 ⓘ You can select “Not Use” or “Tone 1” to “Tone 8.”  
 ⓘ After each received call is completed, the IP100H will sound the specified tone.

**18 Out of Service Area Notice Tone** ..... Select whether or not the IP100H sounds the Out of service area Notice Tone. (Default: Disable)  
 When “Enable” is selected, the IP100H sounds the Notice Tone when it goes out the service area or returns to the service area.

**19 Sidetone Mute**..... Select whether or not the IP100H uses the Side Tone Mute function. (Default: Disable)  
 When “Enable” is selected, the IP100H mutes the sidetone or monitor audio when it goes out the service area. At that time, you cannot hear your voice from a head set or earphone speaker.  
 ⓘ When “Monitor” or “Sidetone” is set to “Disable” in the Transceiver Settings menu, this function is not activated.

Profile screen

Transceiver Controller > Common Settings > Profile

Profile

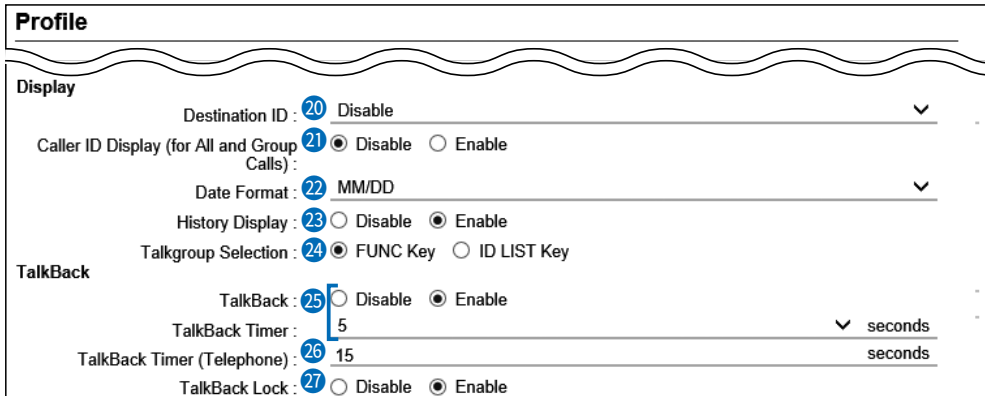

20 Destination ID .....

Select a destination ID that will be displayed after returning to the standby mode. (Default: Disable)

- **Disable:** Displays the destination ID or call type that is specified in [Destination ID] on the [Transceiver Settings] screen.
- **Transmit:** Displays the IDs that the IP100H recently called.
- **Transmit and Receive:** Displays either IDs that the IP100H recently called or was called by.
- **All Operations:** Displays either IDs that the IP100H recently called, was called by or displays the ID list/History.

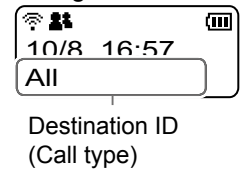

21 Caller ID Display (for All and Group Calls) ...

Select whether or not the IP100H displays the Caller ID in the All call or Group call. (Default: Disable)

- **Disable:** When the IP100H or IP100FS receives an All call or Group call, only the Call type is displayed.
- **Enable:** When the IP100H or IP100FS receives an All call or Group call, both Call type and Caller ID are displayed.

• When receiving an All Call

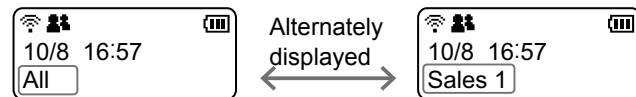

• When receiving an All Call Message

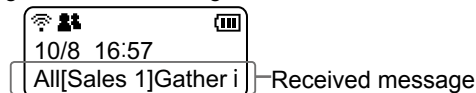

22 Date Format.....

Select a date format to display on the IP100H's standby screen. (Default: MM/DD)

You can select "MM/DD," "DD/MM," "MM-DD," "DD-MM," "MM.DD," or "DD. MM." (MM: Month, DD: Day)

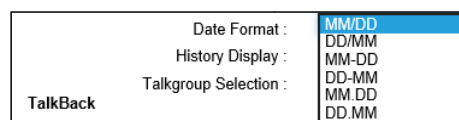

## Profile screen

Transceiver Controller > Common Settings > Profile

### Profile

The screenshot shows the 'Profile' configuration screen. It is divided into two main sections: 'Display' and 'TalkBack'.  
**Display Section:**  
 - Destination ID: 20, set to 'Disable'.  
 - Caller ID Display (for All and Group Calls): 21, with radio buttons for 'Disable' (selected) and 'Enable'.  
 - Date Format: 22, set to 'MM/DD'.  
 - History Display: 23, with radio buttons for 'Disable' and 'Enable' (selected).  
 - Talkgroup Selection: 24, with radio buttons for 'FUNC Key' (selected) and 'ID LIST Key'.  
**TalkBack Section:**  
 - TalkBack: 25, with radio buttons for 'Disable' and 'Enable' (selected).  
 - TalkBack Timer: 25, set to '5' seconds.  
 - TalkBack Timer (Telephone): 26, set to '15' seconds.  
 - TalkBack Lock: 27, with radio buttons for 'Disable' and 'Enable' (selected).

**23 History Display** ..... Set the call history display. (Default: Enable)  
 • **Disable:** Call histories are not displayed on the IP100H, even if you push the [☎] key.  
 • **Enable:** Call histories are displayed on the IP100H when you push the [☎] key.

**24 Talkgroup Selection** ..... Set the key to select the Talkgroup. (Default: FUNC Key)  
 • **FUNC Key:** Select the Talkgroup by pushing the [FUNC] key.  
 • **ID LIST Key:** Select the Talkgroup by pushing the [☎] key.

**25 TalkBack Timer** ..... Enter a time between 1 and 30 seconds that the IP100H will return to the standby mode after a received signal disappears. (Default: 5 (seconds))  
 ① When "Disable" is selected, the IP100H returns to the standby mode (standby screen) as soon as the status indicator goes out.

**26 TalkBack Timer (Telephone)** ..... Enter a time between 0 and 600 seconds that the IP100H will return to the standby mode after a received signal from a telephone disappears. (Default: 15 (seconds))  
 ① When "0" is selected, the TalkBack timer (Telephone) is disabled. In that case, the connection does not terminate until the telephone hangs up, or the IP100H terminates the call by pushing the [Option] key.

**27 TalkBack Lock** ..... Select whether or not the TalkBack Lock function is "Disable" or "Enable." (Default: Enable)  
 • **Enable:** When another call is received in the TalkBack timer time after a call is finished and the IP100H returns to the standby mode, accepts to receive it if higher priority level call is received, or refuses if the same or lower priority level call is received than the finished call. After the TalkBack timer has passed, a new call can be received.  
 • **Disable:** Accepts to receive a new call after your current call is finished.

## Profile screen

Transceiver Controller > Common Settings > Profile

### ■ Profile

- 28 TOT** ..... Select whether or not the IP100H uses the Time-out timer.  
(Default: Disable)

  - ① When “Enable” is selected, the [TOT Timer] (29), [Penalty Timer] (30), [TOT Beep] (31), [TOT on Telephone Call] (32) are displayed.
  - ① This function is useful when the IP100H’s PTT switch has accidentally been held down.
  
- 29 TOT Timer** ..... Set the Time-out timer. The timer limits the IP100H’s continuous transmission.  
(Default: 180)

  - Range: 11 and 600 (seconds)
  - ① When the period of time has passed, transmitting automatically stops.
  
- 30 Penalty Time** ..... Set the TOT Penalty time. After the [TOT timer] (29) period ends, the TOT Penalty timer starts and inhibits the user from transmitting during the penalty period.  
(Default: 30)

  - Range: 1 ~ 600 (seconds)
  
- 31 TOT Beep** ..... Select whether or not the IP100H uses the TOT beep function.  
(Default: Enable)

  - ① When “Enable” is selected, a beep sounds 10 seconds before the period of time that is set in the [TOT Timer] (29) ends.

Profile screen

Transceiver Controller > Common Settings > Profile

■ Profile

- 32 TOT on Telephone Call.....**      Select whether or not the IP100H uses the Time-out timer on Telephone Call. (Default: Enable)  
 ⓘ When “Disable” is set, transmitting does not stop, even if the period of time that is set in the [TOT Timer] (29) has passed during a telephone call.
- 33 Use PBX Connection .....**      When a phone number from the IP100H is not registered in the [Destination Settings], select “Transceiver Controller Telephone Connection.” (Default: None)
- 34 <Apply> .....**      Click to apply the entries.
- 35 <Reset> .....**      Click to reset the settings.  
 ⓘ You cannot reset after clicking <Apply>.

Profile screen

Transceiver Controller > Common Settings > Profile

### Profile Batch Setting

**Profile Batch Setting**

Range ① \_\_\_\_\_ - \_\_\_\_\_

\* Select Profile No. range.

Refer to ② Default \_\_\_\_\_

- ① **Range** ..... Sets a range of collective Profiles.  
Click <Add> to register consecutive Profiles collectively.  
① If a Profile is already registered, "Overwrite the entry" is displayed.
  
- ② **Refer to**..... Selects the default settings or the programmed settings to refer to.  
(Default: Default)

---

Digital Transceiver (D-TRX) screen .....	7-3
■ Digital Transceiver Connection .....	7-3
■ Digital Transceiver System .....	7-4
■ Digital Transceiver Connection <b>(System: NXDN-Trunking)</b> .....	7-5
■ Communication Settings <b>(System: NXDN-Trunking)</b> .....	7-7
■ Bridge Communication <b>(System: NXDN-Trunking)</b> .....	7-8
■ Digital Transceiver Connection <b>(System: NXDN-Conventional)</b> .....	7-9
■ Communication Settings <b>(System: NXDN-Conventional)</b> .....	7-11
■ Digital Transceiver Connection <b>(System: dPMR Mode 2)</b> .....	7-12
■ Communication Settings <b>(System: dPMR Mode 2)</b> .....	7-15
■ DTMF Dialing .....	7-16
EXT I/O (EXT) screen .....	7-17
■ EXT I/O Port Mode .....	7-17
■ EXT I/O .....	7-18
■ Transceiver Model .....	7-19
■ Transceiver Connection <b>(Transceiver Model: General Setting)</b> .....	7-20
■ Bridge Communication .....	7-27
■ Transceiver Control.....	7-28
■ DTMF Dialing .....	7-30
■ PTT Control Setting .....	7-31
■ Receive Detection Setting .....	7-32
■ EXT I/O Device Connection .....	7-33
■ Bridge Communication .....	7-34
■ EXT I/O Control .....	7-35
■ EXT Input Settings .....	7-36
■ EXT Output Settings .....	7-43
Emergency Notification screen .....	7-51
■ Bridge Communication .....	7-51
Microphone (MIC) screen .....	7-52
■ Bridge Communication .....	7-52
■ Microphone Control.....	7-53
■ Microphone Input Control .....	7-54
■ Voice Output Control .....	7-55

RoIP Gateway screen .....	7-56
■ RoIP Gateway .....	7-56
■ RoIP Gateway Connection .....	7-57
■ RoIP Gateway Communication .....	7-59
■ RoIP Gateway Control .....	7-60
■ Bridge Communication .....	7-61



## Digital Transceiver (D-TRX) screen

Connection Port Settings > Digital Transceiver (D-TRX)

### ■ Digital Transceiver Connection

Select a digital transceiver to connect to the RoIP Gateway.

<b>Digital Transceiver</b>
Port Selection : <u>Digital Transceiver1 (D-TRX1)</u> ▼

**Port Selection** ..... Select a Digital Transceiver port to edit the settings.  
(Default: Digital Transceiver 1 (D-TRX1))

Digital Transceiver (D-TRX) screen

Connection Port Settings > Digital Transceiver (D-TRX)

## ■ Digital Transceiver System

Select a digital transceiver system that you want to connect the RoIP Gateway to.

**Digital Transceiver System**

---

System : NXDN Trunking ▼

\*Each setting is initialized after changing.

**System** ..... Select a digital transceiver system, and then click <Apply> to apply.  
(Default: NXDN Trunking)

① The settings on this screen will be initialized after clicking <Apply>.

## Digital Transceiver (D-TRX) screen

Connection Port Settings > Digital Transceiver (D-TRX)

### Digital Transceiver Connection System: NXDN-Trunking

Edit the settings of the Digital transceiver to connect to the RoIP Gateway. You can connect a maximum of 4 digital transceivers to the network.

**Digital Transceiver Connection**

---

Connected Repeater's Address: ① \_\_\_\_\_

Connected Repeater's Port Number: ② 41220

Source Port Number: ③ 43000

Connection Key Code: ④ ucr5000

Area Bit: ⑤  OFF  ON

Integrator Code: ⑥ 1

System Code: ⑦ 1

**Unit**

Prefix ID: ⑧ 1

Unit ID: ⑨ 1

**Talkgroup**

Prefix ID: ⑩ 1

Talkgroup ID: ⑪ 1

**Encryption**

Encryption: ⑫  Disable  Enable

Encryption Key: 1

**Status**

Connection Status: ⑬ Disconnected Connect Refresh

① The above screen shows an example for connecting the IC-FR5000 (with UC-FR5000 installed) to the Digital Transceiver 1 (D-TRX1).

② The above screen shows when the Encryption is set to "Enable."

- ① **Connected Repeater's Address**    Enter the UC-FR5000's IP address.
  
- ② **Connected Repeater's Port Number** .....    Enter the Connection Receive Port number that is set in the UC-FR5000. Do not duplicate the other port number.  
(Default: Digital Transceiver 1 (D-TRX1): 41220  
Default: Digital Transceiver 2 (D-TRX2): 41221  
Default: Digital Transceiver 3 (D-TRX3): 41222  
Default: Digital Transceiver 4 (D-TRX4): 41223)  
• Range: 1 ~ 65535
  
- ③ **Source Port Number** .....    Enter the Local Port number that is set in the UC-FR5000. Do not duplicate the other port number.  
(Default: Default: Digital Transceiver 1 (D-TRX1): 43000  
Default: Digital Transceiver 2 (D-TRX2): 43001  
Default: Digital Transceiver 3 (D-TRX3): 43002  
Default: Digital Transceiver 4 (D-TRX4): 43003)  
• Range: 1 ~ 65535
  
- ④ **Connection Key Code** .....    Enter the Key Code that is set in the UC-FR5000.    (Default: ucr5000)
  
- ⑤ **Area Bit** .....    Turn the Area Bit function ON or OFF, according to the UC-FR5000 setting.    (Default: OFF)
  
- ⑥ **Integrator Code** .....    Displays the Integrator Code that is set in the UC-FR5000.

## Digital Transceiver (D-TRX) screen

Connection Port Settings > Digital Transceiver (D-TRX)

### Digital Transceiver Connection (System: NXDN-Trunking)

① The above screen shows an example for connecting the IC-FR5000 (with UC-FR5000 installed) to the Digital Transceiver 1 (D-TRX1).

① The above screen shows when the Encryption is set to “Enable.”

- ⑦ **System Code** ..... Displays the System Code that is set in the UC-FR5000.
- ⑧ **Prefix ID** ..... Enter the Prefix ID (for NXDN Trunking) that is set in the UC-FR5000. (Default: 1)
  - Range: 1 ~ 30
- ⑨ **Unit ID** ..... Enter the Unit ID that are set in the UC-FR5000. (Default: 1)
  - Range: 1 ~ 2000
- ⑩ **Prefix ID** ..... Enter the Prefix ID (for NXDN Trunking) that is set in the UC-FR5000. (Default: 1)
  - Range: 1 ~ 30
- ⑪ **Talkgroup ID** ..... Enter a Talkgroup ID. (Default: 1)
  - Range: 1 ~ 2000
- ⑫ **Encryption** ..... Select whether or not to enable the Encryption function. (Default: Disable) When you enable the function, enter an encryption key between 1 and 32767. (Default: 1)
- ⑬ **Connection Status** ..... Click to connect or disconnect the transceiver, or to refresh the connection status.
  - ① The buttons are grayed out when Connected Repeater’s Address is blank.
  - ① The settings cannot be changed while connection is established. Click <Disconnect> before changing the settings on this screen.

## Digital Transceiver (D-TRX) screen

Connection Port Settings > Digital Transceiver (D-TRX)

### ■ Communication Settings System: NXDN-Trunking

Edit the settings required for calling transceivers from the digital transceiver connected to the RoIP Gateway.

**Communication Settings**

---

TalkBack :  Disable  Enable

TalkBack Time :  seconds

---

RX All Call :  Disable  Enable

Default Callee ID

Call Type :

---

Destination Prefix ID :

Destination ID :

- 1 TalkBack** ..... Select whether or not to enable to talkback from a client transceiver, when a digital transceiver that is connected to the RoIP Gateway has called to the client transceiver. (Default: Enable)  
 When the function is enabled, select the TalkBack time. (Default: 5)  
 • Range: 1 ~ 10 (seconds)
- 2 RX All Call** ..... Select whether or not to permit all Talkgroups to receive a call. (Default: Disable)
- 3 Call Type** ..... Select a call type to call from the transceiver, that is connected to the RoIP Gateway, to its client transceiver(s). (Default: Group)  
 • Options: Individual, Group, or All
- 4 Destination Prefix ID** ..... Enter a destination prefix ID of a client transceiver. (Default: 1)  
 • Range: 1 ~ 30
- 5 Destination ID** ..... Displayed only when the Call Type (3) is set to "Individual" or "Group."  
 Enter an Individual or Group ID of the client transceiver. (Default: 1)  
 • Range: 1 ~ 2000.

Digital Transceiver (D-TRX) screen

Connection Port Settings > Digital Transceiver (D-TRX)

■ **Bridge Communication** (System: NXDN-Trunking)

Set Talkback Time for calling digital transceivers from the digital transceiver connected to the RoIP Gateway.

Bridge Communication	
TalkBack Time :	<input type="text" value="5"/> <span>seconds</span>

**TalkBack Time** ..... Select the TalkBack time. (Default: 5)  
• Range: 1 ~ 10 (seconds)

Digital Transceiver (D-TRX) screen

Connection Port Settings > Digital Transceiver (D-TRX)

**Digital Transceiver Connection** (System: NXDN-Conventional)

Edit the settings of the digital transceiver to connect to the RoIP Gateway. You can connect a maximum of 4 digital transceivers to the network.

① The above screen shows an example for connecting the IC-FR5000 (with UC-FR5000 installed) to the Digital transceiver 1 (D-TRX1).

① The above screen shows when the Digital Frame Packet (5) and Scrambler (11) are set to “enabled,” and Specify TX CC (10) is checked.

**1 Connected Repeater’s Address** Enter the UC-FR5000’s IP address.

**2 TCP Port Number (Connection Port)** ..... Enter the Connection Receive Port number that is set in the UC-FR5000. Do not duplicate the other port number.

- (Default: Digital Transceiver 1 (D-TRX1): 41200
- Digital Transceiver 2 (D-TRX2): 41201
- Digital Transceiver 3 (D-TRX3): 41202
- Digital Transceiver 4 (D-TRX4): 41203)

• Range: 1024 ~ 65535

**3 UDP Port Number (Data Port)** ..... Enter the Data Receive Port number that is set in the UC-FR5000. Do not duplicate the other port number.

- (Default: Digital Transceiver 1 (D-TRX1): 41220
- Digital Transceiver 2 (D-TRX2): 41221
- Digital Transceiver 3 (D-TRX3): 41222
- Digital Transceiver 4 (D-TRX4): 41223)

• Range: 1024 ~ 65535

**4 Connection Key Code** ..... Enter the Key Code that is set in the UC-FR5000. (Default: ucfr5000)

**5 Digital Frame Packet** ..... Select whether or not to enable the Packet Encryption function, according to the UC-FR5000 setting. (Default: Disable)  
When you enable the function, enter an 8 digit Common key. (Default: 00000000)

## Digital Transceiver (D-TRX) screen

### Connection Port Settings > Digital Transceiver (D-TRX)

#### ■ Digital Transceiver Connection (System: NXDN-Conventional)

**Digital Transceiver Connection**

---

Connected Repeater's Address : ① \_\_\_\_\_

TCP Port Number (Connection Port) : ② .41200

UDP Port Number (Data Port) : ③ .41220

Connection Key Code : ④ .ucfr5000

**Packet Encryption**

Digital Frame Packet : ⑤  Disable  Enable

Common Key : \_\_\_\_\_

**Unit**

Unit ID : ⑥ 1

**Talkgroup**

Talkgroup ID : ⑦ 1

**RAN**

RX RAN : ⑧ 1

Specify TX RAN : ⑨  Specify

**Encryption**

Encryption : ⑩  Disable  Enable

Encryption Key : \_\_\_\_\_

**Status**

Connection Status : ⑪ Disconnected

① The above screen shows an example for connecting the IC-FR5000 (with UC-FR5000 installed) to the Digital transceiver 1 (D-TRX1).

② The above screen shows when the Digital Frame Packet (⑤) and Scrambler (⑩) are set to “enabled,” and Specify TX CC (⑩) is checked.

- |                           |   |              |
|---------------------------|---|--------------|
| ⑥ Unit ID .....           | Enter a unit ID.<br>• Range: 1 ~ 65519  | (Default: 1) |
| ⑦ Talkgroup ID .....      | Enter a Talkgroup ID.<br>• Range: 1 ~ 65519   | (Default: 1) |
| ⑧ RX RAN .....            | Enter an RX RAN code.<br>• Range: 0 ~ 63  | (Default: 1) |
| ⑨ Specify TX RAN .....    | Check to separately enter the TX RAN. (Default: Unchecked)<br>When checked, enter a TX RAN code between 0 and 63. (Default: 1)  | (Default: 1) |
| ⑩ Encryption .....        | Select whether or not to enable the Encryption function.<br>(Default: Disable)<br>When you enable the function, enter an Encryption key between 1 and 32767. (Default: 1)   | (Default: 1) |
| ⑪ Connection Status ..... | Click to connect or disconnect the transceiver, or to refresh the connection status.<br>① The buttons are grayed out when Connected Repeater's Address is blank.<br>② The settings cannot be changed while connection is established. Click <Disconnect> before changing the settings on this screen. |              |



## Digital Transceiver (D-TRX) screen

Connection Port Settings > Digital Transceiver (D-TRX)

### ■ Communication Settings System: NXDN-Conventional

Edit the settings required for calling transceivers from the digital transceiver connected to the RoIP Gateway.

**Communication Settings**

---

TalkBack : 1  Disable  Enable

TalkBack Time : 5 ▼ seconds

Digital SQL : 2  Disable  Enable

RX All Call : 3  Disable  Enable

Default Callee ID

Call Type : 4 ▼  
Group

Destination ID : 5 1

- 1 TalkBack** ..... Select whether or not to enable the TalkBack function. (Default: Enable)  
 When the TalkBack function is ON, Select the TalkBack Time.  
 • Range: 1 ~ 10 seconds (Default: 5)
- 2 Digital SQL** ..... Select whether or not to enable the Digital Squelch function.  
(Default: Disable)
- 3 RX All Call** ..... Select whether or not to permit all Talkgroups to receive a call.  
(Default: Disable)
- 4 Call Type** ..... Select a call type. (Default: Group)  
 • Options: Individual, Group, or All
- 5 Destination ID** ..... Enter a destination ID. (Default: 1)  
 • Range: 1 ~ 65519.

## Digital Transceiver (D-TRX) screen

Connection Port Settings > Digital Transceiver (D-TRX)

### ■ Digital Transceiver Connection System: dPMR Mode 2

Configure the digital transceiver to connect to the RoIP Gateway. You can connect maximum of 4 digital transceivers through the network.

**Digital Transceiver Connection**

Connected Repeater's Address : ① \_\_\_\_\_

TCP Port Number (Connection Port) : ② 41200

UDP Port Number (Data Port) : ③ 41220

Connection Key Code : ④ ucfr5000

**Packet Encryption**

Digital Frame Packet : ⑤  Disable  Enable

Common Key : 00000000

**Unit**

Unit ID : ⑥ 201

**RX ID Range**

Talkgroup ID (Start) : ⑦ 100000

**Talkgroup**

Talkgroup ID : ⑧ 100000

**CC**

RX CC : ⑨ 0

Specify TX CC : ⑩  Specify

TX CC : 0

**Scrambler**

Scrambler : ⑪  Disable  Enable

Key : 1

**Status**

Connection Status : ⑫ Disconnected Connect Refresh

① The above screen shows an example for connecting the IC-FR5000 (with UC-FR5000 installed) to Digital Transceiver 1 (D-TRX1).

① The above screen shows when the Digital Frame Packet (⑤) and Scrambler (⑪) are set to "Enable," and Specify TX CC (⑩) is checked.

**① Connected Repeater's Address** Enter the UC-FR5000's IP address.

**② TCP Port Number (Connection Port)** ..... Enter the Connection Receive Port number that is set in the UC-FR5000. Do not duplicate the other port number.  
 (Default: Digital Transceiver 1 (D-TRX1): 41200  
 Digital Transceiver 2 (D-TRX2): 41201  
 Digital Transceiver 3 (D-TRX3): 41202  
 Digital Transceiver 4 (D-TRX4): 41203)

- Range: 1 ~ 65535

**③ UDP Port Number (Data Port)** ..... Enter the Data Receive Port number that is set in the UC-FR5000. Do not duplicate the other port number.  
 (Default: Digital Transceiver 1 (D-TRX1): 41220  
 Digital Transceiver 2 (D-TRX2): 41221  
 Digital Transceiver 3 (D-TRX3): 41222  
 Digital Transceiver 4 (D-TRX4): 41223)

- Range: 1 ~ 65535

**④ Connection Key Code** ..... Enter the Key Code that is set in the UC-FR5000. (Default: ucfr5000)

## Digital Transceiver (D-TRX) screen

Connection Port Settings > Digital Transceiver (D-TRX)

### Digital Transceiver Connection (System: dPMR Mode 2)

① The above screen shows an example for connecting the IC-FR5000 (with UC-FR5000 installed) to Digital Transceiver 1 (D-TRX1).

① The above screen shows when the Digital Frame Packet (5) and Scrambler (11) are set to “Enable,” and Specify TX CC (10) is checked.

- 5 Digital Frame Packet** ..... Select whether or not to enable the Packet Encryption function, according to the UC-FR5000 setting. (Default: Disable)  
When you enable the function, enter an 8 digit Common key. (Default: 00000000)
- 6 Unit ID** ..... Enter a unit ID. (Default: Digital Transceiver (D-TRX1): 201  
Digital Transceiver (D-TRX2): 202  
Digital Transceiver (D-TRX3): 203  
Digital Transceiver (D-TRX4): 204)

  - Range: 1 ~ 9999999
- 7 Talkgroup ID (Start)** ..... Enter a Talkgroup start ID. (Default: 100000)

  - Range: 1 ~ 9999999
- 8 Talkgroup ID** ..... Enter a Talkgroup ID. (Default: 100000)

  - Range: 1 ~ 9999999
- 9 RX CC** ..... Enter a CC for receiving. (Default: 0)

  - Range: 0 ~ 63
- 10 Specify TX CC** ..... Check to separately enter the TX CC. (Default: Unchecked)  
When checked, enter a TX CC code between 0 and 63. (Default: 0)

  - ① Do not duplicate the RX CC.

## Digital Transceiver (D-TRX) screen

### Connection Port Settings > Digital Transceiver (D-TRX)

#### ■ Digital Transceiver Connection (System: dPMR Mode 2)

**Digital Transceiver Connection**

Connected Repeater's Address: ① \_\_\_\_\_

TCP Port Number (Connection Port): ② 41200 \_\_\_\_\_

UDP Port Number (Data Port): ③ 41220 \_\_\_\_\_

Connection Key Code: ④ ucfr5000 \_\_\_\_\_

**Packet Encryption**

Digital Frame Packet: ⑤  Disable  Enable

Common Key: 00000000 \_\_\_\_\_

**Unit**

Unit ID: ⑥ 201 \_\_\_\_\_

**RX ID Range**

Talkgroup ID (Start): ⑦ 100000 \_\_\_\_\_

**Talkgroup**

Talkgroup ID: ⑧ 100000 \_\_\_\_\_

**CC**

RX CC: ⑨ 0 \_\_\_\_\_

Specify TX CC: ⑩  Specify

TX CC: 0 \_\_\_\_\_

**Scrambler**

Scrambler: ⑪  Disable  Enable

Key: 1 \_\_\_\_\_

**Status**

Connection Status: ⑫ Disconnected

① The above screen shows an example for connecting the IC-FR5000 (with UC-FR5000 installed) to the Digital transceiver 1 (D-TRX1).

① The above screen shows when the Digital Frame Packet (⑤) and Scrambler (⑪) are set to "enabled," and Specify TX CC (⑩) is checked.

**⑪ Scrambler** ..... Check to enable the Scrambler function . (Default: Disable)  
When checked, enter a scrambler key between 1 and 32767. (Default: 1)

**⑫ Connection Status** ..... Click to connect or disconnect the transceiver, or to refresh the connection status.

① The buttons are grayed out when Connected Repeater's Address is blank.

① The settings cannot be changed while connection is established. Click <Disconnect> before changing the settings on this screen.

## Digital Transceiver (D-TRX) screen

Connection Port Settings > Digital Transceiver (D-TRX)

### ■ Communication Settings System: dPMR Mode 2

Edit the settings required for calling transceivers from the digital transceiver connected to the RoIP Gateway.

**Communication Settings**

---

TalkBack : ①  Disable  Enable

TalkBack Time : 5 ▼ seconds

Digital SQL : ②  Disable  Enable

RX All Call : ③  Disable  Enable

Default Callee ID

Call Type : ④ Group ▼

Destination ID : ⑤ 100000

- ① **TalkBack** ..... Select whether or not to enable the TalkBack function. (Default: Disable)  
 When the TalkBack function is ON, Select the TalkBack time. (Default: 5)

  - Range: 1 ~ 10 seconds
  
- ② **Digital SQL** ..... Select whether or not to enable the Digital Squelch function. (Default: Disable)
  
- ③ **RX All Call** ..... Select whether or not to permit all Talkgroups to receive a call. (Default: Disable)
  
- ④ **Call Type** ..... Select a call type. (Default: Group)

  - Options: Individual, Group, or All
  
- ⑤ **Destination ID** ..... Enter a destination ID. (Default: 100000)

  - Range: 1 ~ 9999999

## Digital Transceiver (D-TRX) screen

Connection Port Settings > Digital Transceiver (D-TRX)

### DTMF Dialing

Edit the details on DTMF Dialing.

**DTMF Dialing**

---

DTMF Dialing : ①  Disable  Enable

Timer

Permissible Tone Gap : ② 5 ▼ seconds

OFF-hook Detect Timer : ③ 400 ▼ milliseconds  
\*Applied only if the OFF-hook settings in [Special Number] are set to values with one digit.

ON-hook Detect Timer : ④ 400 ▼ milliseconds  
\*Applied only if the ON-hook setting in [Special Number] is set to a value with one digit.

① The screen above shows when “DTMF Dialing” (①) is set to “Enable.”

- ① **DTMF Dialing** ..... Select “Enable” to use DTMF signaling.  
If enabled, set the details in the Timer. (Default: Disable)
  
- ② **Permissible Tone Gap** ... Select the period of time to detect that the last digit has been input.  
(Default: 5)
  - Range: 1~10 (seconds)
  
- ③ **OFF-hook Detect Timer** ... Select the period of time to detect the OFF-hook control signal.  
(Default: 400)
  - Range: 0~2000 (milliseconds) in 100 millisecond steps
  
- ④ **ON-hook Detect Timer** ..... Select the period of time to detect the ON-hook control signal.  
(Default: 400)
  - Range: 0~2000 (milliseconds) in 100 millisecond steps

① ③ and ④ are the timers for the Transceiver Special Number. (PBX > Special Number > Transceiver Special Number)

## EXT I/O (EXT) screen

Connection Port Settings > EXT I/O (EXT)

### ■ EXT I/O Port Mode

Select the type of device, and then select its input/output mode of te EXT1 ~ EXT4 ports.

**NOTE:** If you change an EXT I/O Port Mode, the settings on this screen will be initialized.

EXT I/O Port Mode	
EXT I/O1 (EXT1)	Connected Unit : Transceiver
EXT I/O2 (EXT2)	Connected Unit : Transceiver
EXT I/O3 (EXT3)	Connected Unit : ① EXT I/O Unit
	EXT I/O Port Mode : ② Separate
EXT I/O4 (EXT4)	Connected Unit : EXT I/O Unit
	EXT I/O Port Mode : Separate
<input type="button" value="Apply"/> <input type="button" value="Reset"/>	

- ① **Connected Unit** ..... Select the type of device to connect to the EXT ports.  
 (Default for EXT I/O 1 (EXT1): Transceiver  
 Default for EXT I/O 2 (EXT2): Transceiver  
 Default for EXT I/O 3 (EXT3): EXT I/O Unit  
 Default for EXT I/O 4 (EXT4): EXT I/O Unit)
- ② **EXT I/O Port Mode** ..... When “EXT I/O Unit” is selected, select the EXT input/output mode.  
 (Default: Separate)
- **Separate:** Separately controls the external audio input/output.
  - **Combined:** Simultaneously controls the external audio input/output to and from an external device. Select this option to connect an external device to A1/A2 (Audio output) and A3/A4 (Audio input) terminals.

EXT I/O (EXT) screen

Connection Port Settings > EXT I/O (EXT)

■ EXT I/O

Select an External I/O port on the RoIP Gateway to edit the settings.

<b>EXT I/O</b>
EXT I/O Port: <u>EXT I/O1 (EXT1)</u> ▼

**EXT I/O Port** ..... Select an External I/O Port to edit the settings.  
(Default: EXT I/O (EXT1))



EXT I/O (EXT) screen

Connection Port Settings > EXT I/O (EXT)

### ■ Transceiver Model

This item is displayed when “Transceiver” is selected as a connected unit.  
(Connection Port Settings > EXT I/O (EXT) > EXT I/O Port Mode > EXT I/O 1 ~ 4 > Connected Unit)  
(Connection Port Settings > EXT I/O (EXT) > EXT I/O > EXT I/O Port)

Transceiver Model	
Transceiver Model :	IC-F5060/F6060 <span style="float: right;">▼</span>
<small>*Remove the transceiver from the main unit before changing this setting. All the settings on this page will be initialized if you change this setting.</small>	

- Transceiver Model** ..... Select a transceiver to connect the port selected in “EXT I/O Port.”  
(Default: IC-F5060/F6060)
- ① Select “General Setting,” if the transceiver requires detailed settings.
  - ① Follow the local laws and regulations when using transceivers other than the options.
  - ① Remove the transceiver from the RoIP Gateway to change the Transceiver Model. All settings will be reset to the defaults.

## EXT I/O (EXT) screen

Connection Port Settings > EXT I/O (EXT)

### ■ Transceiver Connection Transceiver Model: General Setting

- This item is displayed when “Transceiver” is selected as a connected unit.  
 (Connection Port Settings > EXT I/O (EXT) > EXT I/O Port Mode)  
 (Connection Port Settings > EXT I/O (EXT) > EXT I/O > EXT I/O Port)

**Transceiver Connection**

---

TX Volume Offset to the Transceiver : ① -15 ▼ dB

RX Volume Offset from the Transceiver : ② -24 ▼ dB

PTT Type : ③  Separate PTT  Combined with Microphone Line

PTT Logic : ④  Active High  Active Low

SQL Type : ⑤  Separate SQL  Combined with Speaker Line

SQL Logic : ⑥  High  Low

Power ON/OFF Detection : ⑦  Disable  Enable

Power ON/OFF Detection Signal : ⑧ Use PTT Type ▼

Power ON/OFF Detection Signal Logic : ⑨  High  Low

Detection Invalidity Timer (OFF ⇒ ON) : ⑩ 0 milliseconds  
\*Setting value is set in five milliseconds steps.

Uses Pin A3 Bidirectional : ⑪  Disable  Enable

Serial Communication : ⑫  Disable  Enable

⑧ ~ ⑩ are displayed only when Power ON/OFF Detection (⑦) is set to “Enable.”

- ① TX Volume Offset to the Transceiver** .....

Adjust the RoIP Gateway’s transmitting audio level that is sent to the connected transceiver. (Default: -15)

  - Range: -43 ~ +20 (dB)
  - ① A higher level makes the microphone more sensitive to a small voice, and is suitable for a quiet environment.
  - A lower level makes the microphone less sensitive to the voice, and is suitable for a noisy environment with a louder voice.
  
- ② RX Volume Offset from the Transceiver** .....

Adjust the RoIP Gateway’s audio level from the transceiver. (Default: -24)

  - Range: -74 ~ +21 (dB)
  
- ③ PTT Type** .....

Select the PTT circuit type. (Default: Separate PTT)

  - **Separate PTT:** The microphone line and PTT input line are separated.
  - **Combined with Microphone Line:** The PTT input line is superimposed on the MIC input (A1 terminal).
  
- ④ PTT Logic** .....

Select the PTT logic. (Default: Active Low)

  - **Active High:** PTT line becomes “High” when [PTT] is pushed. (Active High)
  - **Active Low:** PTT line becomes “Low” when [PTT] is pushed. (Active Low)

## EXT I/O (EXT) screen

### Connection Port Settings > EXT I/O (EXT)

#### ■ Transceiver Connection (Transceiver Model: General Setting)

These items are displayed when “Transceiver” is selected as a connected unit.

(Connection Port Settings > EXT I/O (EXT) > EXT I/O Port Mode > EXT I/O 1 ~ 4 > Connected Unit)

(Connection Port Settings > EXT I/O (EXT) > EXT I/O > EXT I/O Port)

**Transceiver Connection**

TX Volume Offset to the Transceiver : ① -15 ▼ dB

RX Volume Offset from the Transceiver : ② -24 ▼ dB

PTT Type : ③  Separate PTT  Combined with Microphone Line

PTT Logic : ④  Active High  Active Low

SQL Type : ⑤  Separate SQL  Combined with Speaker Line

SQL Logic : ⑥  High  Low

Power ON/OFF Detection : ⑦  Disable  Enable

Power ON/OFF Detection Signal : ⑧ Use PTT Type ▼

Power ON/OFF Detection Signal Logic : ⑨  High  Low

Detection Invalidation Timer (OFF ⇒ ON) : ⑩ 0 milliseconds  
\*Setting value is set in five milliseconds steps.

Uses Pin A3 Bidirectional : ⑪  Disable  Enable

Serial Communication : ⑫  Disable  Enable

① ⑧ ~ ⑩ are displayed only when Power ON/OFF Detection (⑦) is set to “Enable.”

- ⑤ SQL Type** ..... Select the squelch signal type. (Default: Separate SQL)

  - **Separate SQL:** The squelch signal is separately input.
  - **Combined with Speaker Line:** The squelch signal is superimposed on the speaker input line (A3 terminal).
  
- ⑥ SQL Logic** ..... Select the squelch detection type. (Default: High)

  - **High:** The squelch line becomes “High” while receiving a signal. (Active High)
  - **Low:** The squelch line becomes “Low” while receiving a signal. (Active Low)
  
- ⑦ Power ON/OFF Detection** Select “Enable” to detect the transceiver’s power status (ON/OFF). (Default: Disable)
  
- ⑧ Power ON/OFF Detection Signal** ..... Select the PTT type to detect the transceiver’s power status (ON/OFF). (Default: Use PTT Type)

  - **Separate PTT:** The microphone line and PTT input line are separated.
  - **Combined with Microphone Line:** The PTT input line is superimposed on the MIC input (A1 terminal).
  - **Use PTT Type:** The PTT type selected in PTT type (③) is used.
  
- ⑨ Power ON/OFF Detection Signal Logic** ..... Select the logic to detect the transceiver’s power status (ON/OFF). (Default: High)

  - **High:** Becomes High when the transceiver’s power is ON. (Active high)
  - **Low:** Becomes Low when the transceiver’s power is ON. (Active low)

## EXT I/O (EXT) screen

### Connection Port Settings > EXT I/O (EXT)

#### ■ Transceiver Connection (Transceiver Model: General Setting)

These items are displayed when “Transceiver” is selected as a connected unit.

(Connection Port Settings > EXT I/O (EXT) > EXT I/O Port Mode > EXT I/O 1 ~ 4 > Connected Unit)

(Connection Port Settings > EXT I/O (EXT) > EXT I/O > EXT I/O Port)

**Transceiver Connection**

---

TX Volume Offset to the Transceiver : ① -15 ▼ dB

RX Volume Offset from the Transceiver : ② -24 ▼ dB

PTT Type : ③  Separate PTT  Combined with Microphone Line

PTT Logic : ④  Active High  Active Low

SQL Type : ⑤  Separate SQL  Combined with Speaker Line

SQL Logic : ⑥  High  Low

Power ON/OFF Detection : ⑦  Disable  Enable

Power ON/OFF Detection Signal : ⑧ Use PTT Type ▼

Power ON/OFF Detection Signal Logic : ⑨  High  Low

Detection Invalidity Timer (OFF ⇒ ON) : ⑩ 0 milliseconds  
\*Setting value is set in five milliseconds steps.

Use Pin A3 Bidirectional : ⑪  Disable  Enable

Serial Communication : ⑫  Disable  Enable

① ⑧ ~ ⑩ are displayed only when Power ON/OFF Detection (⑦) is set to “Enable.”

#### ⑩ Detection Invalidity Timer

(OFF → ON) .....

Set the power ON/OFF detection delay time between 0 and 10000 milliseconds. (Default: 0)

When power ON is detected, the RoIP Gateway mutes the audio input from the transceiver. The detection delay is the amount of time that the RoIP Gateway detects the power status before the RoIP Gateway recognizes the power status.

① If “0” is set, the audio input from the transceiver is not muted, even if the power ON status is detected.

#### ⑪ Use Pin A3 Bidirectional ...

Select “Enable” to use one common line (A3 terminal) as the MIC input and AF output. If your transceiver commonly uses 1 line as the MIC input and AF output, select “Enable.” (Default: Disable)

#### ⑫ Serial Communication .....

Select “Enable” to use serial communication. (Default: Disable)

\*Items ⑬ ~ ⑳ are displayed when “Enable” is selected.

## EXT I/O (EXT) screen

### Connection Port Settings > EXT I/O (EXT)

#### ■ Transceiver Connection (Transceiver Model: General Setting)

These items are displayed when “Transceiver” is selected as a connected unit.

(Connection Port Settings > EXT I/O (EXT) > EXT I/O Port Mode > EXT I/O 1 ~ 4 > Connected Unit)

(Connection Port Settings > EXT I/O (EXT) > EXT I/O > EXT I/O Port)

Serial Communication :	12	<input type="radio"/> Disable	<input checked="" type="radio"/> Enable
Client Mode :	13	<input checked="" type="radio"/> Disable	<input type="radio"/> Enable
TCP Port Number :	14	50000	
Communication Control :	15	<input checked="" type="radio"/> Full-Duplex	<input type="radio"/> Half-Duplex
Signal Level :	16	±5V (RS-232C) ▼	
Data Mode :	17	<input type="radio"/> Auto	<input checked="" type="radio"/> Manual
Baud Rate :	27	9600 ▼	
Data Bits :	28	8 ▼	
Parity :	29	None ▼	
Stop Bits :	30	1 ▼	
Flow Control :	31	None ▼	
Session Timer :	33	30	
Transceiver Control :	18	<input type="radio"/> Disable	<input checked="" type="radio"/> Enable
Transceiver Mode :	19	NXDN Conventional ▼	
<b>Default Callee ID</b>			
Call Type :	20	Group ▼	
Destination Prefix ID :	21		
Destination ID :	22	1	
Source Prefix ID :	23		
Source ID :	24	1	

① 13 ~ 17 are displayed only when Serial Communication (12) is set to “Enable”

① 27 ~ 33 and 18 are displayed only when Data Mode (17) is set to “Manual.”

① 19 ~ 24 are displayed only when Transceiver control (18) is set to “Enable.”

**13 Client Mode** ..... Select “Enable” to set the RoIP Gateway as the client in serial communications. (Default: Disable)

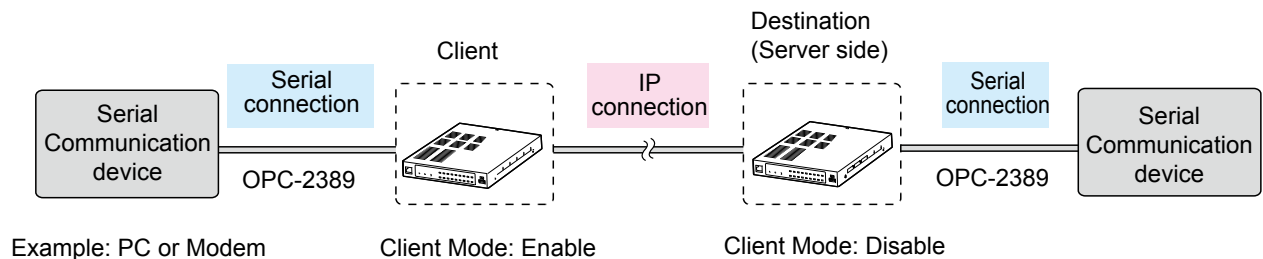

## EXT I/O (EXT) screen

### Connection Port Settings > EXT I/O (EXT)

#### ■ Transceiver Connection (Transceiver Model: General Setting)

These items are displayed when “Transceiver” is selected as a connected unit.

(Connection Port Settings > EXT I/O (EXT) > EXT I/O Port Mode > EXT I/O 1 ~ 4 > Connected Unit)

(Connection Port Settings > EXT I/O (EXT) > EXT I/O > EXT I/O Port)

Serial Communication :	12	<input type="radio"/> Disable	<input checked="" type="radio"/> Enable
Client Mode :	13	<input checked="" type="radio"/> Disable	<input type="radio"/> Enable
TCP Port Number :	14	50000	
Communication Control :	15	<input checked="" type="radio"/> Full-Duplex	<input type="radio"/> Half-Duplex
Signal Level :	16	±5V (RS-232C) ▼	
Data Mode :	17	<input type="radio"/> Auto	<input checked="" type="radio"/> Manual
Baud Rate :	27	9600 ▼	
Data Bits :	28	8 ▼	
Parity :	29	None ▼	
Stop Bits :	30	1 ▼	
Flow Control :	31	None ▼	
Session Timer :	33	30	
Transceiver Control :	18	<input type="radio"/> Disable	<input checked="" type="radio"/> Enable
Transceiver Mode :	19	NXDN Conventional ▼	
<b>Default Callee ID</b>			
Call Type :	20	Group ▼	
Destination Prefix ID :	21		
Destination ID :	22	1	
Source Prefix ID :	23		
Source ID :	24	1	

① 13 ~ 17 are displayed only when Serial Communication (12) is set to “Enable”

① 27 ~ 33 and 18 are displayed only when Data Mode (17) is set to “Manual.”

① 19 ~ 24 are displayed only when Transceiver control (18) is set to “Enable.”

① The screen below shows when :

- Serial Communication (12) is set to “Enable.”
- Client Mode (13) is set to “Enable.”

Serial Communication :	12	<input type="radio"/> Disable	<input checked="" type="radio"/> Enable
Client Mode :	13	<input type="radio"/> Disable	<input checked="" type="radio"/> Enable
Server Address :	25		
Server Port Number :	26	50000	
Communication Control :	15	<input checked="" type="radio"/> Full-Duplex	<input type="radio"/> Half-Duplex
Signal Level :	16	±5V (RS-232C) ▼	
Baud Rate :	27	9600 ▼	
Data Bits :	28	8 ▼	
Parity :	29	None ▼	
Stop Bits :	30	1 ▼	
Flow Control :	31	None ▼	
Connection Status :	32	Disconnected <input type="button" value="Connect"/> <input type="button" value="Refresh"/>	

## EXT I/O (EXT) screen

### Connection Port Settings > EXT I/O (EXT)

#### ■ Transceiver Connection (Transceiver Model: General Setting)

These items are displayed when “Transceiver” is selected as a connected unit.  
 (Connection Port Settings > EXT I/O (EXT) > EXT I/O Port Mode > EXT I/O 1 ~ 4 > Connected Unit)  
 (Connection Port Settings > EXT I/O (EXT) > EXT I/O > EXT I/O Port)

- 14 TCP Port Number** ..... Enter a port number between 1024 and 65535.  
 (Default: EXT1=50000, EXT2=50001, EXT3=50002, EXT4=50003)
- 15 Communication Control** ... Select the communication type, Full-Duplex or Half Duplex.  
 (Default: Full-Duplex)
- 16 Signal Level** ..... Select the serial communication line logic voltage level.  
 (Default: ±5V(RS-232C))  
 • Options: ±5V(RS-232C), 0V/3V (Logic), or 0V/5V (Logic)
- 17 Data Mode** ..... Select the communication method for serial communication between a device and the RoIP Gateway. (Default: Auto)  
 • **Auto:** Automatically starts serial communication from a Virtual Serial Port installed on your PC.  
 • **Manual:** Manually set serial communication method for a device.  
 \*Items 27 ~ 31, and 33 are displayed when “Manual” is selected.
- 18 Transceiver Control** ..... Select “Enable” to control the transceiver using serial communication.  
 (Default: Disable)  
 \*Items 19 ~ 24 are displayed when “Enable” is selected.
- 19 Transceiver Mode** ..... Select an operating mode. (Default: NXDN Conventional)  
 • Options: NXDN Conventional, NXDN Trunking, dPMR, or SAT.
- 20 Call Type** ..... Select a call type. (Default: Group)  
 • Options: Individual, Group, or All
- 21 Destination Prefix ID** ..... Enter a destination prefix ID. The ID may differ, depending on the system. (Default: Blank)  
 • Range: 0 ~ 30
- 22 Destination ID** ..... Enter the default ID for the EXT port between 00001 and 9999999.  
 (Default: 1)  
 ⓘ Enter an ID between 00001 and 99999 when the Destination Prefix ID (21) is entered.
- 23 Source Prefix ID** ..... Enter a station’s source prefix ID. The ID may differ, depending on the system. (Default: Blank)  
 • Range: 0 ~ 30
- 24 Source ID** ..... Enter a station’s source ID between 00001 and 9999999. The ID is sent to the destination. (Default: 1)  
 ⓘ Enter an ID between 00001 and 99999 when the Source Prefix ID (23) is entered.

## EXT I/O (EXT) screen

### Connection Port Settings > EXT I/O (EXT)

#### ■ Transceiver Connection Transceiver Model: General Setting

These items are displayed when “Transceiver” is selected as a connected unit.

(Connection Port Settings > EXT I/O (EXT) > EXT I/O Port Mode > EXT I/O 1 ~ 4 > Connected Unit)

(Connection Port Settings > EXT I/O (EXT) > EXT I/O > EXT I/O Port)

- |                                    |   |
|------------------------------------|---|
| <b>25 Server Address</b> .....     | Enter a destination RoIP Gateway's IP address.  |
| <b>26 Server Port Number</b> ..... | Enter a destination RoIP Gateway's port number between 1024 and 65535.<br>(Default: EXT1=50000, EXT2=50001, EXT3=50002, EXT4=50003)   |
| <b>27 Baud Rate</b> .....          | Select the serial communication baud rate between a device and the RoIP Gateway. (Default: 9600)  |
| <b>28 Data Bits</b> .....          | Select the number of bits for serial communication. (Default: 8)  |
| <b>29 Parity</b> .....             | Select the parity bit. (Default: none)  |
| <b>30 Stop Bits</b> .....          | Select the stop bit length. (Default: 1)  |
| <b>31 Flow Control</b> .....       | Select the Flow control option. (Default: None)   |
| <b>32 Connection Status</b> .....  | Click to connect or disconnect the transceiver, or to refresh the connection status.<br>① The buttons are grayed out when Connected Repeater's Address is blank.<br>① The settings cannot be changed while connection is established. Click <Disconnect> before changing the settings on this screen. |
| <b>33 Session Timer</b> .....      | Set the time to cut the TCP session when there is no communication from the host. (Default: 30)   |



## EXT I/O (EXT) screen

Connection Port Settings > EXT I/O (EXT)

### ■ Bridge Communication

These items are displayed when “Transceiver” is selected as a connected unit.  
 (Connection Port Settings > EXT I/O (EXT) > EXT I/O Port Mode > EXT I/O 1 ~ 4 > Connected Unit)  
 (Connection Port Settings > EXT I/O (EXT) > EXT I/O > EXT I/O Port)

Edit the Bridge Communication settings for transceivers connected to the EXT1 ~ EXT4 ports.  
 These items are Displayed only when “Connection Unit” is set to “Transceiver.”

**Bridge Communication**

Encryption : ①  Disable  Enable

Encryption Key : ① \_\_\_\_\_

TalkBack : ②  Disable  Enable

TalkBack Time : ⑤ \_\_\_\_\_ seconds

Default Callee ID

Call Type : ③ \_\_\_\_\_

Destination Prefix ID : ④ \_\_\_\_\_

Destination ID : ⑤ 1

Source ID : ⑥ .301

- ① The above screen shows when Encryption (①) is set to “Enable.”
- ① ②~⑤ are not displayed when the Transceiver Model is set to “IC-SAT100.”

- ① Encryption** ..... Select whether or not to enable the Encryption function. (Default: Disable)

When you enable the function, enter an encryption key between 1 and 32767. (Default: 1)
- ② TalkBack** ..... Select whether or not to enable the TalkBack function. (Default: Enable)

When the function is enabled, Select the TalkBack time. (Default: 5)

  - Range: 1 ~ 10 (seconds)
- ③ Call Type** ..... Select a call type. (Default: Group)

  - Options: Individual, Group, or All
- ④ Destination Prefix ID** ..... Enter a destination prefix ID. The ID may differ, depending on the system. (Default: Blank)

  - Range: 0 ~ 30
- ⑤ Destination ID** ..... Enter the default ID for the EXT port between 00001 and 9999999. (Default: 1)

  - ① Enter an ID between 00001 and 99999 when the Destination Prefix ID (④) is entered.
- ⑥ Source ID** ..... Enter a station’s source ID between 1 and 9999999. The ID is sent to the destinations. (Default: EXT1=301, EXT2=302, EXT3=303, EXT4=304)

## EXT I/O (EXT) screen

Connection Port Settings > EXT I/O (EXT)

### ■ Transceiver Control

These items are displayed when “Transceiver” is selected as a connected unit.  
 (Connection Port Settings > EXT I/O (EXT) > EXT I/O Port Mode > EXT I/O 1 ~ 4 > Connected Unit)  
 (Connection Port Settings > EXT I/O (EXT) > EXT I/O > EXT I/O Port)

Edit the control settings for transceivers connected to the EXT1 ~ EXT4 ports.  
 These items are displayed only when “Connection Unit” is set to “Transceiver.”

**Transceiver Control**

---

Prioritized Receive : ①  Disable  Enable

PTT Control : ② RTP ▼

Receive Detection : ③ VOX ▼

Insert RX Audio to TX Audio : ④  Disable  Enable

TX Volume : ⑤ 0 ▼ dB

RX Volume : ⑥ 0 ▼ dB

Additional Attack Time for Beep : ⑦ 400 milliseconds

Sound Elimination : \*Setting value is set in five milliseconds steps.

Echo Canceller : ⑧  Disable  Enable

Noise Canceller : ⑨  Disable  Enable

① ②, ⑧ and ⑨ are displayed only when the Transceiver Model is set to “General Setting.”  
 ① Only ⑤ and ⑥ are displayed when the Transceiver Model is set to “IC-SAT100.”

- ① Prioritized Receive** ..... Select “Enable” to keep receiving and inhibit the transmission, while the transceiver is receiving. The default value differs, depending on the Transceiver Mode.
- ② PTT Control** ..... Select the audio transmission method. (Default: RTP)

  - **VOX:** According to the input audio signal level.
  - **RTP:** The RoIP Gateway sends the PTT control signal to the transceiver during receiving an applicable RTP packet.
  - **PTT Always-ON:** The RoIP Gateway always sends the PTT control signal to the transceiver to transmit.
  - **No PTT Control:** The RoIP Gateway does not send the PTT control signal to the transceiver.
- ③ Receive Detection** ..... Select the received audio detection method. The default value differs, depending on the Transceiver Mode.

  - **VOX:** According to the input audio signal level.
  - **SQL:** According to the squelch status (Open/Close)  
When setting to “SQL,” set also Pull-up Control ON or OFF.
  - **Always Receive:** Always in the receive mode.
  - **PC CMD:** According to the PC command. (Displayed only when the Transceiver Model is set to “General Settings.”)
- ④ Insert RX Audio to TX Audio** ..... Select “Enable” to mix the audio from the repeater with the audio from the telephone. (Default: Disable)  
 ① When “Enable” is selected, select “Disable” in Prioritized Receive (①).
- ⑤ TX Volume** ..... Adjust the RoIP Gateway’s transmitting audio level that is sent to the connected transceiver. (Default: 0)

  - Range: -12 ~ +6 (dB)

## EXT I/O (EXT) screen

### Connection Port Settings > EXT I/O (EXT)

#### ■ Transceiver Control

These items are displayed when “Transceiver” is selected as a connected unit.  
 (Connection Port Settings > EXT I/O (EXT) > EXT I/O Port Mode > EXT I/O 1 ~ 4 > Connected Unit)  
 (Connection Port Settings > EXT I/O (EXT) > EXT I/O > EXT I/O Port)

Edit the control settings for transceivers connected to the EXT1 ~ EXT4 ports.  
 These items are displayed only when “Connection Unit” is set to “Transceiver.”

**Transceiver Control**

---

Prioritized Receive : ①  Disable  Enable

PTT Control : ② RTP ▼

Receive Detection : ③ VOX ▼

Insert RX Audio to TX Audio : ④  Disable  Enable

TX Volume : ⑤ 0 ▼ dB

RX Volume : ⑥ 0 ▼ dB

Additional Attack Time for Beep Sound Elimination : ⑦ 400 milliseconds

\*Setting value is set in five milliseconds steps.

Echo Canceller : ⑧  Disable  Enable

Noise Canceller : ⑨  Disable  Enable

① ②, ⑧ and ⑨ are displayed only when the Transceiver Model is set to “General Setting.”

- ⑥ **RX Volume** ..... Adjust the RoIP Gateway’s audio output level of the audio signal that is received from the connected transceiver (Default: 0)  
 • Range: -12 ~ +6 (dB)
- ⑦ **Additional Attack Time for Beep Sound Elimination** ... Enter the period of time to mute the audio (including beep signals) from the connected transceiver. (Default: 400)  
 • Range: 0 ~ 1000 (seconds) in 5 millisecond steps
- ⑧ **Echo Canceller** ..... Select whether or not to enable the Echo Canceller function. The function reduces echo caused during duplex communication. (Default: Disable)
- ⑨ **Noise Canceller** ..... Select whether or not to enable the Noise Canceller function. (Default: Disable)

## EXT I/O (EXT) screen

Connection Port Settings > EXT I/O (EXT)

### ■ DTMF Dialing

These items are displayed when “Transceiver” is selected as a connected unit (except for the Transceiver Model is set to “IC-SAT100.”)

(Connection Port Settings > EXT I/O (EXT) > EXT I/O Port Mode > EXT I/O 1 ~ 4 > Connected Unit)

(Connection Port Settings > EXT I/O (EXT) > EXT I/O > EXT I/O Port)

Edit the DTMF Dialing settings.

#### DTMF Dialing

DTMF Dialing: ①  Disable  Enable

Timer

Permissible Tone Gap: ② 5 ▼ seconds

OFF-hook Detect Timer: ③ 400 ▼ milliseconds  
\*Applied only if the OFF-hook settings in [Special Number] are set to values with one digit.

ON-hook Detect Timer: ④ 400 ▼ milliseconds  
\*Applied only if the ON-hook setting in [Special Number] is set to a value with one digit.

① ② ~ ④ are displayed only when the DTMF Dialing (①) is set to “Enable.”

① **DTMF Dialing** ..... Select whether or not to use the DTMF Dialing function. (Default: Disable)

② **Permissible Tone Gap** ... Select the period of time to detect that the last digit has been input.  
 (Default: 5)  
 • Range: 1 ~ 10 (seconds)

③ **OFF-hook Detect Timer** ... Select the period of time to detect the OFF-hook control signal.  
 (Default: 400)  
 • Range: 0 ~ 2000 (milliseconds) in 100 millisecond steps

④ **ON-hook Detect Timer** ..... Select the period of time to detect the ON-hook control signal.  
 (Default: 400)  
 • Range: 0 ~ 2000 (milliseconds) in 100 millisecond steps

① ③ and ④ are the timers for the Transceiver Special Number. (PBX > Special Number > Transceiver Special Number)

## EXT I/O (EXT) screen

Connection Port Settings > EXT I/O (EXT)

### ■ PTT Control Setting

These items are displayed when “Transceiver” is selected as a connected unit (except for the Transceiver Model is set to “IC-SAT100.”)

(Connection Port Settings > EXT I/O (EXT) > EXT I/O Port Mode > EXT I/O 1 ~ 4 > Connected Unit)

(Connection Port Settings > EXT I/O (EXT) > EXT I/O > EXT I/O Port)

Edit the PTT control settings.

PTT Control Setting	
*Setting values of Attack Time, Release Time and Voice Delay are set in five milliseconds steps.	
Attack Time : ①	50 milliseconds
Release Time : ②	500 milliseconds
Voice Delay : ③	200 milliseconds
VOX Threshold : ④	40 %

① ① and ④ are displayed only when Connection Unit is set to “Transceiver,” Transceiver Model is set to “General Setting,” and PTT Control is set to “VOX.”

① ② and ③ are displayed only when Connection Unit is set to “Transceiver.”

- ① Attack Time** ..... Set the TX Attack time to between 5 and 500 milliseconds. It is the delay time before the VOX switch turns ON after an audio signal is received through the network. (Default: 50)
- ② Release Time** ..... Set the RX Delay time. It is the delay time for the VOX switch to turn OFF after no audio signal is received through the network. (Default: 500)

① When the PTT Control in [Transceiver Control] is set to “RTP,” the default value is “200.”

  - Range: 5 ~ 2000 (milliseconds)
- ③ Voice Delay** ..... Enter the amount of time to store the audio, in 5 millisecond steps. (Default: 200)

① When the PTT Control in [Transceiver Control] is set to “RTP,” the default value is “300.”

  - Range: 0 ~ 1500 (milliseconds)
- ④ VOX Threshold** ..... Enter the voice threshold level. (Default: 40)

  - Range: 0 ~ 100 (%)

## EXT I/O (EXT) screen

Connection Port Settings > EXT I/O (EXT)

### Receive Detection Setting

These items are displayed when “Transceiver” is selected as a connected unit.  
 (Connection Port Settings > EXT I/O (EXT) > EXT I/O Port Mode > EXT I/O 1 ~ 4 > Connected Unit)  
 (Connection Port Settings > EXT I/O (EXT) > EXT I/O > EXT I/O Port)

Edit the DTMF Dialing settings.

**Receive Detection Setting**

\*Setting values of Attack Time, Release Time and Voice Delay are set in five milliseconds steps.

Attack Time :	① 50	milliseconds
Release Time :	② 200	milliseconds
Voice Delay :	③ 50	milliseconds
VOX Threshold :	④ 40	%
Ignore Time :	⑤ 300	milliseconds

- ① ① and ④ are displayed only when “Connection Unit” is set to “Transceiver,” and the “Receive Detection” is set to “VOX.”
- ① ② is displayed only when “Connection Unit” is set to “Transceiver,” and the “Receive Detection” is set to “VOX” or “SQL.”
- ① ③ is displayed only when “Connection Unit” is set to “Transceiver.”
- ① ⑤ is displayed only when “Connection Unit” is set to “Transceiver,” and the “Receive Detection” is set to “SQL.”

- ① Attack Time** ..... Set the TX Attack time. It is the delay time before the VOX switch turns ON after an audio signal is received through the network. (Default: 50)  
 • Range: 5 ~ 2000 (milliseconds) in 5 millisecond steps
- ② Release Time** ..... Set the RX Delay time. It is the delay time for the VOX switch to turn OFF after no audio signal is received through the network. (Default: 200)  
 • Range: 5 ~ 2000 (milliseconds) in 5 millisecond steps
- ③ Voice Delay** ..... Enter the period of time to store the audio. (Default: 5)  
 ① When the Receive Detection is set to “VOX,” the default value is “50.”  
 • Range: 0 ~ 1500 (milliseconds) in 5 millisecond steps
- ④ VOX Threshold** ..... Enter the voice threshold level. (Default: 40)  
 • Range: 0 ~ 100 (%)
- ⑤ Ignore Time** ..... Enter the period of time to ignore the detected SQL signal. (Default: 300)  
 • Range: 0 ~ 2000 (milliseconds) in 5 millisecond steps

## EXT I/O (EXT) screen

Connection Port Settings > EXT I/O (EXT)

### ■ EXT I/O Device Connection

This item is displayed only when “Connected Unit” is set to “EXT I/O Unit, and ”EXT I/O Port Mode” is set to “Combined.”(Connection Port Settings > EXT I/O (EXT) )

EXT I/O Device Connection	
Connected EXT I/O Unit :	General Setting 
<small>*Remove the transceiver from the main unit before changing this setting. All the settings on this page will be initialized if you change this setting.</small>	

**Connected EXT I/O Unit** ..... Select the connected external input/output unit.

## EXT I/O (EXT) screen

Connection Port Settings > EXT I/O (EXT)

### ■ Bridge Communication

Edit the Bridge Communication settings for external input/output devices connected to the EXT1 ~ EXT4 ports. These items are displayed only when “Connected Unit” is set to “EXT I/O Unit, and ”EXT I/O Port Mode” is set to “Combined.”(Connection Port Settings > EXT I/O (EXT) )

**Bridge Communication**

---

Encryption : ①  Disable  Enable  
 Encryption Key : ①

TalkBack : ②  Disable  Enable  
 TalkBack Time : ②  seconds

Default Callee ID

Call Type : ③

Destination Prefix ID : ④

Destination ID : ⑤

Source ID : ⑥

- ① Encryption** ..... Select whether or not to enable the Encryption function. (Default: Disable)  
 When you enable the function, enter an encryption key between 1 and 32767. (Default: 1)
- ② TalkBack** ..... Select whether or not to enable the TalkBack function. (Default: Enable)  
 When the function is enabled, Select the TalkBack time. (Default: 5)  
 • Range: 1 ~ 10 (seconds)
- ③ Call Type** ..... Select a call type. (Default: Group)  
 • Options: Individual, Group, or All
- ④ Destination Prefix ID** ..... Enter a destination prefix ID. The ID may differ, depending on the system. (Default: Blank)  
 • Range: 0 ~ 30
- ⑤ Destination ID** ..... Enter the default ID for the EXT port between 1 and 9999999. (Default: 1)  
 ⓘ Enter an ID between 00001 and 99999 when the Destination Prefix ID (④) is entered.
- ⑥ Source ID** ..... Enter a station’s source ID between 1 and 9999999. The ID is sent to the destinations. (Default: EXT1=301, EXT2=302, EXT3=303, EXT4=304)



EXT I/O (EXT) screen

Connection Port Settings > EXT I/O (EXT)

### ■ EXT I/O Control

Edit the input/output settings of the RoIP Gateway's EXT1 ~ EXT4 ports. These items are displayed only when "Connected Unit" is set to "EXT I/O Unit, and "EXT I/O Port Mode" is set to "Combined."(Connection Port Settings > EXT I/O (EXT) )

<b>EXT I/O Control</b>
Echo Canceller : ① <input checked="" type="radio"/> Disable <input type="radio"/> Enable
Noise Canceller : ② <input checked="" type="radio"/> Disable <input type="radio"/> Enable

- ① Echo Canceller** ..... Select whether or not to enable the Echo Canceller function. The function reduces echo caused by receiving more than 2 calls at the same time. (Default: Disable)
- ② Noise Canceller** ..... Select whether or not to enable the Noise Canceller function. (Default: Disable)

## EXT I/O (EXT) screen

Connection Port Settings > EXT I/O (EXT)

### ■ EXT Input Settings

Edit the input settings of the RoIP Gateway's EXT1 ~ EXT4 ports.

#### EXT Input Settings

**Bridge Communication**

Encryption : ①  Disable  Enable

Encryption Key : ② 1

**Default Callee ID**

Call Type : ③ Group

Destination Prefix ID : ④

Destination ID : ⑤ 1

Source ID : ⑥ 353

**Input Port Settings**

Input Connection Port : ⑦ IP Network

Input Control : ⑧ Control Signal

Power for the Microphone : ⑨  Disable  Enable

Reference Level : ⑩ -10dBs

Input Gain (Analog) : ⑪ 0 dB

Input Gain (Digital) : ⑫ 0 dB

**Input Control Signal Settings**

Control Signal Type : ⑬ Momentary

ON Timer : ⑭ 1 seconds

OFF Timer : ⑮ 1 seconds

Control Logic : ⑯ Short Circuit (LOW)

Control Input Pull-up Setting : ⑰  Disable  Enable

**Input Control Setting**

Voice Delay : ⑱ 5 milliseconds

\*Setting value is set in five milliseconds steps.

① ① ~ ⑤ are displayed only when "Connected Unit" is set to "EXT I/O Unit, and "EXT I/O Port Mode" is set to "Separate." (Connection Port Settings > EXT I/O (EXT) )

- ① **Encryption** ..... Select whether or not to enable the Encryption function. (Default: Disable)  
When you enable the function, enter an encryption key between 1 and 32767. (Default: 1)
- ② **Call Type** ..... Select a call type. (Default: Group)
- ③ **Destination Prefix ID** ..... Enter a destination prefix ID. The ID may differ, depending on the system. (Default: Blank)  
• Range: 0 ~30
- ④ **Destination ID** ..... Enter the default ID for the EXT port between 1 and 9999999. (Default: 1)  
① Enter an ID between 00001 and 99999 when the Destination Prefix ID (③) is entered.
- ⑤ **Source ID** ..... Enter a station's source ID between 1 and 9999999. The ID is sent to the destinations. (Default: EXT1=301, EXT2=302, EXT3=303, EXT4=304)  
① When EXT I/O Port Mode is set to "Separate," the default values are EXT1=351, EXT2=352, EXT3=353, and EXT4=354.

## EXT I/O (EXT) screen

### Connection Port Settings > EXT I/O (EXT)

#### ■ EXT Input Settings

<b>Input Port Settings</b>	
Input Connection Port :	⑥ IP Network <span style="float:right">▼</span>
Input Control :	⑦ Control Signal <span style="float:right">▼</span>
Power for the Microphone :	⑧ <input checked="" type="radio"/> Disable <input type="radio"/> Enable
Reference Level :	⑨ -10dBs <span style="float:right">▼</span>
Input Gain (Analog) :	⑩ 0 <span style="float:right">▼ dB</span>
Input Gain (Digital) :	⑪ 0 <span style="float:right">▼ dB</span>
<b>Input Control Signal Settings</b>	
Control Signal Type :	⑫ Momentary <span style="float:right">▼</span>
ON Timer :	⑬ 1 <span style="float:right">▼ seconds</span>
OFF Timer :	⑭ 1 <span style="float:right">▼ seconds</span>
Control Logic :	⑮ Short Circuit (LOW) <span style="float:right">▼</span>
Control Input Pull-up Setting :	⑯ <input type="radio"/> Disable <input checked="" type="radio"/> Enable
<b>Input Control Setting</b>	
Voice Delay :	⑰ 5 <span style="float:right">milliseconds</span>
*Setting value is set in five milliseconds steps.	

#### ⑥ Input Connection Port .....

Select the port which outputs the received audio signal.

(Default: IP Network)

- **EXT Output:** Sends the audio signal to the devices that are connected to EXT1 ~ EXT4 ports.
- **IP Network:** Sends the audio signal to the devices that are connected to the RoIP Gateway through the IP network.
- **Emergency:** Sends the audio signal to the device that is specified as the emergency call destination in the “Emergency Notification.”  
(Expert Settings > Emergency Notification)
  - ① Emergency communication has priority over normal communication.
  - ① The RoIP Gateway enters the Emergency mode when the option selected in the Input Control (⑧) of the EXT1 ~ EXT4 ports are satisfied.
  - ① In the Emergency mode, all ongoing communication routes, other than that for the Emergency Notice, are disconnected.
  - ① To transmit the call as the Emergency Notice:
    - Confirm the “Bridge Communication Source” is set to “Emergency Notification.”  
(Bridge Connection Settings > Bridge Connection > Bridge Connection > Bridge Connection Source)
    - Confirm the “Bridge Communication Destination” is set to “Custom Bridge Connection.”  
(Bridge Connection Settings > Bridge Connection > Bridge Connection > Bridge Communication Destination)
    - Confirm the “Emergency Notification Equipment” is set to “Enable.”  
(Expert Settings > Emergency Notification > Emergency Notification > Emergency Notification Equipment)

## EXT I/O (EXT) screen

### Connection Port Settings > EXT I/O (EXT)

#### ■ EXT Input Settings

<b>Input Port Settings</b>	
Input Connection Port :	6 IP Network <span style="float:right">▼</span>
Input Control :	7 Control Signal <span style="float:right">▼</span>
Power for the Microphone :	8 <input checked="" type="radio"/> Disable <input type="radio"/> Enable
Reference Level :	9 -10dBs <span style="float:right">▼</span>
Input Gain (Analog) :	10 0 <span style="float:right">▼ dB</span>
Input Gain (Digital) :	11 0 <span style="float:right">▼ dB</span>
<b>Input Control Signal Settings</b>	
Control Signal Type :	12 Momentary <span style="float:right">▼</span>
ON Timer :	13 1 <span style="float:right">▼ seconds</span>
OFF Timer :	14 1 <span style="float:right">▼ seconds</span>
Control Logic :	15 Short Circuit (LOW) <span style="float:right">▼</span>
Control Input Pull-up Setting :	16 <input type="radio"/> Disable <input checked="" type="radio"/> Enable
<b>Input Control Setting</b>	
Voice Delay :	17 5 <span style="float:right">milliseconds</span>

\*Setting value is set in five milliseconds steps.

- 7 Input Control** ..... Select the control type to send the audio signal. (Default: Control Signal)

  - **Always-ON:** Always sends the audio signal to the destination selected in the Input Connection Port (7).
  - ① When “Emergency” is selected in Input Connection Port (7), this option cannot be selected.
  - **VOX:** When an audio signal is input, sends the audio signal to the destination selected in the Input Connection Port (7).
  - **Control Signal:** When the control signal is input, sends the audio signal to the destination selected in the Input Connection Port (7).
  
- 8 Power for the Microphone** ..... Select “Enable” to supply the voltage to the microphone connected to A3/A4 terminal (Audio input) microphone. (Default: Disable)
  
- 9 Reference Level** ..... Select the input line A3/A4 terminal (Audio input) sensitivity. (Default: -10dBs)

  - Options: -10 dBs or -40dBs

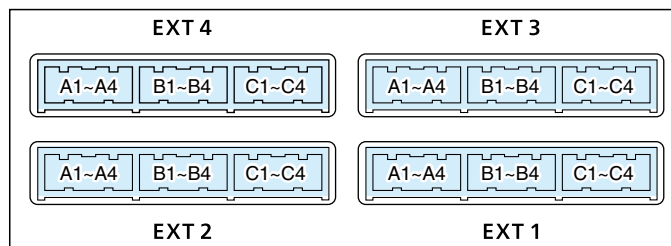

Refer to the INSTALLATION GUIDE Section 6 for the port details.

## EXT I/O (EXT) screen

### Connection Port Settings > EXT I/O (EXT)

#### ■ EXT Input Settings

<b>Input Port Settings</b>	
Input Connection Port :	⑥ IP Network <span style="float:right">▼</span>
Input Control :	⑦ Control Signal <span style="float:right">▼</span>
Power for the Microphone :	⑧ <input checked="" type="radio"/> Disable <input type="radio"/> Enable
Reference Level :	⑨ -10dBs <span style="float:right">▼</span>
Input Gain (Analog) :	⑩ 0 <span style="float:right">▼ dB</span>
Input Gain (Digital) :	⑪ 0 <span style="float:right">▼ dB</span>
<b>Input Control Signal Settings</b>	
Control Signal Type :	⑫ Momentary <span style="float:right">▼</span>
ON Timer :	⑬ 1 <span style="float:right">▼ seconds</span>
OFF Timer :	⑭ 1 <span style="float:right">▼ seconds</span>
Control Logic :	⑮ Short Circuit (LOW) <span style="float:right">▼</span>
Control Input Pull-up Setting :	⑯ <input type="radio"/> Disable <input checked="" type="radio"/> Enable
<b>Input Control Setting</b>	
Voice Delay :	⑰ 5 <span style="float:right">milliseconds</span>
<small>*Setting value is set in five milliseconds steps.</small>	

- ⑩ **Input Gain (Analog)** ..... Set the analog signal input gain (A3/A4 terminal (Audio input)). (Default: 0)  
 • Range: -74 ~ +21 (dB)
- ⑪ **Input Gain (Digital)** ..... Set the digital signal input gain (A3/A4 terminal (Audio input)). (Default: 0)  
 • Range: -12 ~ +6 (dB)

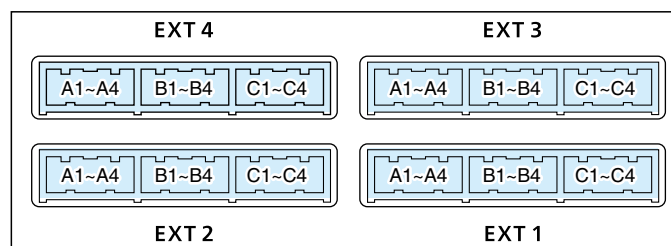

Refer to the INSTALLATION GUIDE Section 6 for the port details.

## EXT I/O (EXT) screen

### Connection Port Settings > EXT I/O (EXT)

#### ■ EXT Input Settings

<b>Input Port Settings</b>	
Input Connection Port :	6 IP Network
Input Control :	7 Control Signal
Power for the Microphone :	8 <input checked="" type="radio"/> Disable <input type="radio"/> Enable
Reference Level :	9 -10dBs
Input Gain (Analog) :	10 0
Input Gain (Digital) :	11 0
<b>Input Control Signal Settings</b>	
Control Signal Type :	12 Momentary
ON Timer :	13 1
OFF Timer :	14 1
Control Logic :	15 Short Circuit (LOW)
Control Input Pull-up Setting :	16 <input type="radio"/> Disable <input checked="" type="radio"/> Enable
<b>Input Control Setting</b>	
Voice Delay :	17 5

\*Setting value is set in five milliseconds steps.

**12 Control Signal Type** ..... Select the control signal input type. (Default: Momentary)

- **Momentary:** While the control signal is input from the B3/B4 terminal (General control I/O), activates the port.
- **One-shot:** When the control signal is input from the B3/B4 terminal (General control I/O), continuously activates the port. And deactivates with no input. The input signal has been detected for the period of time, that is set in the ON Timer (13). The RoIP Gateway recognizes the signal input and retains the type for the period of time, that is set in the OFF Timer (14).

**13 ON Timer** ..... Select the delay time until the input is detected. (Default: 1)

- Range: 0.1 ~ 3 (seconds)

**14 OFF Timer** ..... Select the delay time until the port (B3/B4 terminal (General control input)) is deactivated. (Default: 1)

- Range: 0.1 ~ 3 (seconds)

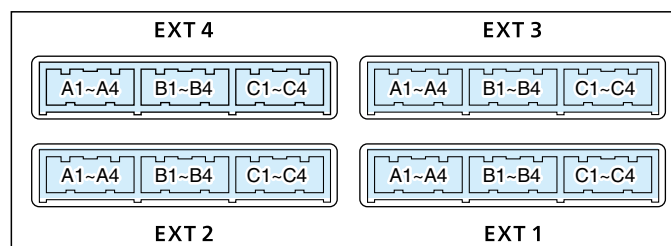

Refer to the INSTALLATION GUIDE Section 6 for the port details.

## EXT I/O (EXT) screen

### Connection Port Settings > EXT I/O (EXT)

#### ■ EXT Input Settings

<b>Input Port Settings</b>	
Input Connection Port :	6 IP Network
Input Control :	7 Control Signal
Power for the Microphone :	8 <input checked="" type="radio"/> Disable <input type="radio"/> Enable
Reference Level :	9 -10dBs
Input Gain (Analog) :	10 0
Input Gain (Digital) :	11 0
<b>Input Control Signal Settings</b>	
Control Signal Type :	12 Momentary
ON Timer :	13 1
OFF Timer :	14 1
Control Logic :	15 Short Circuit (LOW)
Control Input Pull-up Setting :	16 <input type="radio"/> Disable <input checked="" type="radio"/> Enable
<b>Input Control Setting</b>	
Voice Delay :	17 5

\*Setting value is set in five milliseconds steps.

- 15 Control Logic** ..... Select the port input state of the B3/B4 terminals (General control input). (Default: Short Circuit (LOW))  
 The control signal input is detected as follows:  
 When the “Control Input Pull-up Setting” (16) is enabled:
- **Short Circuit (LOW):** Detects when the B3/B4 terminals are Shortened
  - **Open Circuit (HIGH):** Detects when the B3/B4 terminals are Open
- When the “Control Input Pull-up Setting” (16) is disabled:
- **Short Circuit (LOW):** Detects when no volatge is applied between the B3 and B4 terminals.
  - **Open Circuit (HIGH):** Detects when any volatge is applied between the B3 and B4 terminals.
- 16 Control Input Pull-up Setting** Select whether or not to internally pull up the B3/B4 terminal (General control input). (Default: Enable)

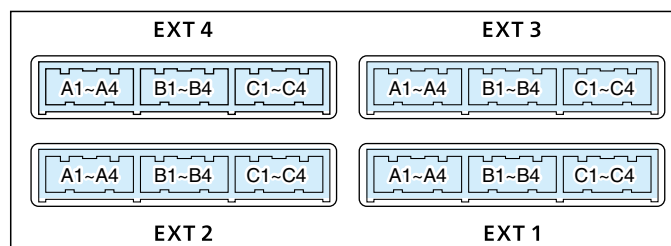

Refer to the INSTALLATION GUIDE Section 6 for the port details.

## EXT I/O (EXT) screen

### Connection Port Settings > EXT I/O (EXT)

#### ■ EXT Input Settings

**Input Port Settings**

Input Connection Port : ⑥ IP Network ▼

Input Control : ⑦ VOX ▼

Power for the Microphone : ⑧  Disable  Enable

Reference Level : ⑨ -10dBs ▼

Input Gain (Analog) : ⑩ 0 ▼ dB

Input Gain (Digital) : ⑪ 0 ▼ dB

**Input Control Setting**

\*Setting values of Attack Time, Release Time and Voice Delay are set in five milliseconds steps.

Attack Time : ⑱ 50 milliseconds

Release Time : ⑲ 200 milliseconds

Voice Delay : ⑰ 50 milliseconds

VOX Threshold : ⑳ 40 %

⑱, ⑲, and ⑳ are displayed when Input Control (⑦) is set to “VOX.”

- ⑰ Voice Delay** ..... Set the audio signal buffer time.  
(Default: when Input Control is “VOX”=50, others=5)  
  - Range: 0 ~ 500 (milliseconds) in 5 millisecond steps
  
- ⑱ Attack Time** ..... Set the TX Attack time. It is the delay time before the VOX switch turns ON after an audio signal is received through the network. (Default: 50)  
Input Control: VOX  
  - Range: 5 ~ 2000 (milliseconds)
  
- ⑲ Release Time** ..... Set the RX Delay time. It is the delay time for the VOX switch to turn OFF after no audio signal is received through the network. (Default: 200)  
Input Control: VOX  
  - Range: 5 ~ 2000 (milliseconds)
  
- ⑳ VOX Threshold** ..... Enter the voice threshold level. (Default: 40)  
Input Control: VOX  
  - Range: 0 ~ 100 (%)

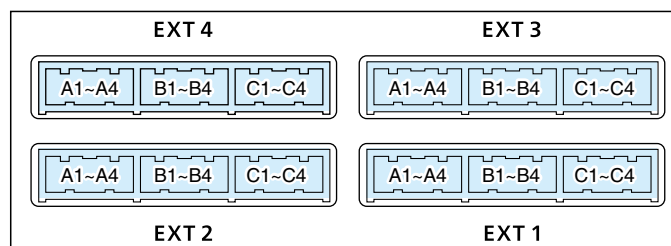

Refer to the INSTALLATION GUIDE Section 6 for the port details.



EXT I/O (EXT) screen

Connection Port Settings > EXT I/O (EXT)

## ■ EXT Output Settings

Edit the output settings of the RoIP Gateway's EXT1 ~ EXT4 ports.

EXT Output Settings	
Bridge Communication	
Encryption: ①	<input type="radio"/> Disable <input checked="" type="radio"/> Enable
Encryption Key:	① _____
Source ID: ②	_____0303

① ① and ② are displayed only when "Connected Unit" is set to "EXT I/O Unit, and "EXT I/O Port Mode" is set to "Separate." (Connection Port Settings > EXT I/O (EXT))

- ① **Encryption** ..... Select whether or not to enable the Encryption function.  
(Default: Disable)  
When you enable the function, enter an encryption key between 1 and 32767. (Default: 1)
- ② **Source ID** ..... Enter a station's source ID between 0001 and 9999.  
(Default: EXT1=301, EXT2=302, EXT=303, EXT4=304)

## EXT I/O (EXT) screen

### Connection Port Settings > EXT I/O (EXT)

#### ■ EXT Output Settings

##### Switching Control: Control Output Circuit

**EXT Output Settings**

---

Control Circuit

Switching Control : ①  Control Output Circuit  Relay Circuit

Control Output Logic : ②  Active High  Active Low

8V Electric Supply (B2) : ③  Disable  Enable

##### Switching Control: Relay Circuit

Control Circuit

Switching Control : ①  Control Output Circuit  Relay Circuit

Control Output Logic : ② Valid Event Detection  
Short

- ③ Switching Control** ..... Select the control circuit type. (Default: Control Output Circuit)

① If "Relay Circuit" is selected, the "Communication Control" is automatically set to "Full-Duplex."  
(Communication Port Settings > EXT I/O (EXT) > Transceiver Connection > Communication Control)
- ④ Control Output Logic** ..... Select the activate state. (Default: Active Low)

Switching Control:  
Control Output Circuit

When the Switching Control (③) is set to "Relay Circuit," select the port state. Relay output terminal (B1/B2 terminal) is short or open circuit. When the audio signal is output, the control signal is also output. (Default: Short)
- ⑤ 8V Electric Supply (B2)** ... Select whether or not to supply the 8 V to the microphone that is connected to the external output terminal. (Default: Disable)

Switching Control:  
Relay Circuit

① Specification: Less than 30 mA  
① If "Enable" is selected, the "Communication Control" is automatically set to "Full Duplex."  
(Communication Port Settings > EXT I/O (EXT) > Transceiver Connection > Communication Control)

## EXT I/O (EXT) screen

### Connection Port Settings > EXT I/O (EXT)

#### ■ EXT Output Settings

##### Client Mode: Disable

**Serial Communication**

Serial Communication : ⑥  Disable  Enable

Client Mode : ⑦  Disable  Enable

TCP Port Number : ⑧ 50003

Communication Control : ⑨  Full-Duplex  Half-Duplex

Signal Level : ⑩ ±5V (RS-232C) ▼

Data Mode : ⑪  Auto  Manual

Baud Rate : ⑫ 9600 ▼

Data Bits : ⑬ 8 ▼

Parity : ⑭ None ▼

Stop Bits : ⑮ 1 ▼

Flow Control : ⑯ None ▼

Session Timer : ⑰ 30

- ① The screen shows Serial Communication (⑥) is set to “Enable,” and Client Mode (⑦) is set to “Disable.”
- ① ⑫ ~⑰ are displayed only when the Data Mode (⑪) is set to “Manual.”

##### Client Mode: Enable

Serial Communication : ⑥  Disable  Enable

Client Mode : ⑦  Disable  Enable

Server Address : ⑱ \_\_\_\_\_

Server Port Number : ⑲ 50002

Communication Control : ⑨  Full-Duplex  Half-Duplex

Signal Level : ⑩ ±5V (RS-232C) ▼

Baud Rate : ⑫ 9600 ▼

Data Bits : ⑬ 8 ▼

Parity : ⑭ None ▼

Stop Bits : ⑮ 1 ▼

Flow Control : ⑯ None ▼

Connection Status : ⑳ Disconnected

- ① The screen shows Serial Communication (⑥) and Client Mode (⑦) is set to “Enable.”

- ⑥ **Serial Communication** ..... Select “Enable” to use serial communications. (Default: Disable)  
\*Items ⑦ ~ ⑪ are displayed when “Enable” is selected.
- ⑦ **Client Mode** ..... Select “Enable” to set the RoIP Gateway as the client in serial communications. (Default: Disable)  
① When Enabling this the Client Mode, enter the Server Address (⑱) and the Server Port number (⑲).
- ⑧ **TCP Port Number** ..... Enter a port number between 1024 and 65535. (Default: EXT1=50000, EXT2=50001, EXT3=50002, EXT4=50003)
- ⑨ **Communication Control** ... Select the communication type. (Default: Full-Duplex)  
① Automatically set to “Full-Duplex” when Switching Control (③) is set to “Relay Circuit.”

## EXT I/O (EXT) screen

### Connection Port Settings > EXT I/O (EXT)

#### ■ EXT Output Settings

**Client Mode: Disable**

**Serial Communication**

Serial Communication : ⑥  Disable  Enable

Client Mode : ⑦  Disable  Enable

TCP Port Number : ⑧ 50003

Communication Control : ⑨  Full-Duplex  Half-Duplex

Signal Level : ⑩ ±5V (RS-232C) ▼

Data Mode : ⑪  Auto  Manual

Baud Rate : ⑫ 9600 ▼

Data Bits : ⑬ 8 ▼

Parity : ⑭ None ▼

Stop Bits : ⑮ 1 ▼

Flow Control : ⑯ None ▼

Session Timer : ⑰ 30

- ① The screen shows Serial Communication (⑥) is set to “Enable,” and Client Mode (⑦) is set to “Disable.”
- ① ⑫ ~⑰ are displayed only when the Data Mode (⑪) is set to “Manual.”

- ⑩ **Signal Level** ..... Select the serial communication line logic voltage level. (Default: ±5V(RS-232C))
- ⑪ **Data Mode** ..... Select the communication method for serial communications between a device and the RoIP Gateway. (Default: Auto)
  - **Auto:** Automatically starts serial communications from a Virtual Serial Port installed on your PC.
  - **Manual:** Manually set serial communication method for a device.
 ① Items ⑫ ~ ⑰ are displayed when “Manual” is selected.
- ⑫ **Baud Rate** ..... Select the serial communication baud rate between a device and the RoIP Gateway. (Default: 9600)
- ⑬ **Data Bits** ..... Select the number of bits for serial communications. (Default: 8)
- ⑭ **Parity** ..... Select the parity bit. (Default: none)
- ⑮ **Stop Bits** ..... Select the stop bit length. (Default: 1)
- ⑯ **Flow Control** ..... Select the Flow control option. (Default: None)
- ⑰ **Session Timer** ..... Set the time to cut the TCP session when there is no communication from the host. (Default: 30)

## EXT I/O (EXT) screen

### Connection Port Settings > EXT I/O (EXT)

#### ■ EXT Output Settings

**Client Mode: Enable**

Serial Communication :	<b>6</b>	<input type="radio"/> Disable	<input checked="" type="radio"/> Enable
Client Mode :	<b>7</b>	<input type="radio"/> Disable	<input checked="" type="radio"/> Enable
Server Address :	<b>18</b>	<input type="text"/>	
Server Port Number :	<b>19</b>	<input type="text" value="50002"/>	
Communication Control :	<b>9</b>	<input checked="" type="radio"/> Full-Duplex	<input type="radio"/> Half-Duplex
Signal Level :	<b>10</b>	<input type="text" value="±5V (RS-232C)"/>	▼
Baud Rate :	<b>12</b>	<input type="text" value="9600"/>	▼
Data Bits :	<b>13</b>	<input type="text" value="8"/>	▼
Parity :	<b>14</b>	<input type="text" value="None"/>	▼
Stop Bits :	<b>15</b>	<input type="text" value="1"/>	▼
Flow Control :	<b>16</b>	<input type="text" value="None"/>	▼
Connection Status :	<b>20</b>	<input type="text" value="Disconnected"/>	<input type="button" value="Connect"/> <input type="button" value="Refresh"/>

① The screen shows Serial Communication (**6**) and Client Mode (**7**) is set to “Enable.”

- 18 Server Address** ..... Enter the destination RoIP Gateway’s IP address.
- 19 Server Port Number** ..... Enter the destination RoIP Gateway’s port number between 1024 and 65535.  
(Default: EXT1=50000, EXT2=50001, EXT3=50002, EXT4=50003)
- 20 Connection Status** ..... Click to connect or disconnect a transceiver, or to refresh the connection status.  
 ① The buttons are grayed out when Connected Repeater’s Address is blank.  
 ① The settings cannot be changed while connection is established. Click <Disconnect> before changing the settings on this screen.

## EXT I/O (EXT) screen

### Connection Port Settings > EXT I/O (EXT)

#### ■ EXT Output Settings

**Audio Output Settings**

Reference Level : 21 -20dBs ▼

Output Gain (Analog) : 22 0 ▼ dB

Output Gain (Digital) : 23 0 ▼ dB

Announce Tone Delay : 24 0.5 seconds ▼

Fade-out : 25 1.5 seconds ▼

Fade-in : 26 1.5 seconds ▼

**Control Output Setting**

\*Setting values of Release Time and Voice Delay are set in five milliseconds steps.

Relay Control : 27 By RTP ▼

Release Time : 28 100 milliseconds

Voice Delay : 29 5 milliseconds

**Announce Tone**

\*Not available with direct output from EXT Input or always-on connections.

Start Tone : 30 Single Tone 1 ▼

End Tone : 31 Not used ▼

Announce Tone Volume : 32 0 ▼ dB

Apply
Reset

- 21 Reference Level** ..... Select the output level of A1/A2 terminal (Audio output). (Default: -20dBs)

  - Options: Speaker, 0dBs, or -20dBs
  
- 22 Output Gain (Analog)** ..... Set the analog signal input gain (A1/A2 terminal (Audio output)). (Default: 0)

  - Range: -43 ~ +20 (dB)
  
- 23 Output Gain (Digital)** ..... Set the digital signal input gain (A1/A2 terminal (Audio output)).(Default: 0)

  - Range: -12 ~ +6 (dB)
  
- 24 Announce Tone Delay** ..... Select the delay time before the received audio is output.  
This delay time is set according to your sound device's specifications.  
The default value differs, depending on the EXT I/O Port Mode setting. (Default: Separate: 0.5 seconds  
Combined: 1.5 seconds)

  - Range: 0.5 ~ 3 (seconds)
  - ① Select "Disable" to output the audio right after the signal is received.
  
- 25 Fade-out** ..... Set the period of time that the audio signal is muted. (Default: 1.5)

  - Range: Disable, or 0.5 ~ 3 (seconds)

The Auto Fader function is usable on the following settings.

  - When the "Connected Unit" is set to "EXT I/O Unit, and "EXT I/O Port Mode" is set to "Separate."  
(Connection Port Settings > EXT I/O (EXT) > EXT I/O Port Mode)
  - ① The "Input connection port" is set to "EXT Output."  
(External input and output ports are directly connected.)  
(Connection Port Settings > EXT I/O (EXT) > EXT Input Settings > Input Connection Port)
  - The "Priority Level" is set to "Priority" or "High Priority."  
(PBX Advanced Settings > Prioritization > EXT Output Port Prioritization > From Other Ports)

## EXT I/O (EXT) screen

### Connection Port Settings > EXT I/O (EXT)

#### ■ EXT Output Settings

**Audio Output Settings**

Reference Level : 21 -20dBs ▼

Output Gain (Analog) : 22 0 ▼ dB

Output Gain (Digital) : 23 0 ▼ dB

Announce Tone Delay : 24 0.5 seconds ▼

Fade-out : 25 1.5 seconds ▼

Fade-in : 26 1.5 seconds ▼

**Control Output Setting**

\*Setting values of Release Time and Voice Delay are set in five milliseconds steps.

Relay Control : 27 By RTP ▼

Release Time : 28 100 milliseconds

Voice Delay : 29 5 milliseconds

**Announce Tone**

\*Not available with direct output from EXT Input or always-on connections.

Start Tone : 30 Single Tone 1 ▼

End Tone : 31 Not used ▼

Announce Tone Volume : 32 0 ▼ dB

Apply
Reset

**26 Fade-in** ..... Set the period of time that the audio signal mute is canceled. (Default: 1.5 seconds)

- Range: Disable, or 0.5 ~ 3 (seconds)

The Auto Fader function is usable on the following settings.

- When the “Connected Unit” is set to “EXT I/O Unit, and ”EXT I/O Port Mode” is set to “Separate.” (Connection Port Settings > EXT I/O (EXT) > EXT I/O Port Mode)
  - ① The “Input connection port” is set to “EXT Output.” (External input and output ports are directly connected.) (Connection Port Settings > EXT I/O (EXT) > EXT Input Settings > Input Connection Port)
- The “From Other Ports” is set to “Priority” or “High Priority.” (PBX Advanced Settings > Prioritization > EXT Output Port Prioritization > From Other Ports)

**27 Relay Control** ..... Displayed when Switching Control (3) is set to “Relay Circuit.” Set the type of relay control. (Default: By RTP)  
Options: By Port Connection or By RTP

**28 Release Time** ..... Set the RX delay time. It is the delay time for the VOX switch to turn OFF after no audio signal is received through the network. (Default: For the Control Output Circuit: 200 For the Relay Circuit: 100)

- Range: For the control output circuit: 5 ~ 2000 (milliseconds)  
For the relay circuit: 5 ~15000 (milliseconds)

**29 Voice Delay** ..... Enter the period of time to store the audio. (Default: 5)

- Range: 0 ~ 1500 (milliseconds) in 5 millisecond steps.

## EXT I/O (EXT) screen

### Connection Port Settings > EXT I/O (EXT)

#### ■ EXT Output Settings

**Audio Output Settings**

Reference Level : 21 -20dBs ▼

Output Gain (Analog) : 22 0 ▼ dB

Output Gain (Digital) : 23 0 ▼ dB

Announce Tone Delay : 24 0.5 seconds ▼

Fade-out : 25 1.5 seconds ▼

Fade-in : 26 1.5 seconds ▼

**Control Output Setting**

\*Setting values of Release Time and Voice Delay are set in five milliseconds steps.

Relay Control : 27 By RTP ▼

Release Time : 28 100 milliseconds

Voice Delay : 29 5 milliseconds

**Announce Tone**

\*Not available with direct output from EXT Input or always-on connections.

Start Tone : 30 Single Tone 1 ▼

End Tone : 31 Not used ▼

Announce Tone Volume : 32 0 ▼ dB

Apply Reset

33 34

- 30 Start Tone** ..... Select the tone which sounds before the announcement starts. (Default: Single Tone1)

  - Options: Not used, 4 Tone Notice (Up), Single Tone 1, or Single Tone 2
  
- 31 End Tone** ..... Select the tone which sounds after the announcement. (Default: Not used)

  - Options: Not used, 4 Tone Notice (Down), Single Tone 1, or Single Tone 2
  
- 32 Announce Tone Volume** ... Select the volume level for the announce tones. (Default: 0)

  - Range: -12 ~ +6 (dB)
  
- 33 <Apply>** ..... Click to apply the settings.
  
- 34 <Reset>** ..... Click to reset the settings.

  - ① You cannot reset after clicking <Apply>.



## Emergency Notification screen

Connection Port Settings > Emergency Notification

### ■ Bridge Communication

Edit the Emergency Notification settings for the transceivers connected by Bridge Mode.

① ③ ~⑥ Displayed only when the Default Callee ID (②) is set to “Enable.”

- ① Encryption** ..... Select whether or not to enable the Encryption function.  
(Default: Disable)  
When you enable the function, enter an encryption key between 1 and 32767.  
(Default: 1)
- ② Default Callee ID** ..... Select “Enable” to add the destination ID to the transmitted signal.  
(Default: Disable)
- ③ Call Type** ..... Select a call type. (Default: Group)  
• Options: Individual, Group, or All
- ④ Destination Prefix ID** ..... Enter a destination prefix ID. The ID may differ, depending on the system. (Default: Blank)  
• Range: 0 ~30
- ⑤ Destination ID** ..... Enter an Individual or Group ID of the destination transceiver between 1 and 9999999. (Default: 1)  
① Enter an ID between 00001 and 99999 when the Destination Prefix ID (④) is entered.
- ⑥ Source ID** ..... Enter a station’s source ID between 1 and 9999999. The ID is sent to the destinations. (Default: 1)
- ⑦ <Apply>** ..... Click to apply the settings.
- ⑧ <Reset>** ..... Click to reset the settings.  
① You cannot reset after clicking <Apply>.

## Microphone (MIC) screen

Connection Port Settings > Microphone (MIC)

### ■ Bridge Communication

Edit the settings of the microphone connected to the RoIP Gateway.

**Bridge Communication**

---

Encryption : ①  Disable  Enable

Encryption Key : ① \_\_\_\_\_

TalkBack : ②  Disable  Enable

TalkBack Time : ② 5 ▼ seconds

Default Callee ID

Call Type : ③ Group ▼

Destination Prefix ID : ④ \_\_\_\_\_

Destination ID : ⑤ 1

Source ID : ⑥ 311

- ① Encryption** ..... Select whether or not to enable the Encryption function. (Default: Disable)

When you enable the function, enter an encryption key between 1 and 32767. (Default: 1)
- ② TalkBack** ..... Select whether or not to enable the TalkBack function.(Default: Enable)

When the function is enabled, Select the TalkBack time. (Default: 5)

  - Range: 1 ~10 (seconds)
- ③ Call Type** ..... Select a call type. (Default: Group)

  - Options: Individual, Group, or All
- ④ Destination Prefix ID** ..... Enter a destination prefix ID. The ID may differ, depending on the system. (Default: Blank)

  - Range: 0 ~30
- ⑤ Destination ID** ..... Enter an Individual or Group ID of the destination transceiver between 1 and 9999999. (Default: 1)

① Enter an ID between 00001 and 99999 when the Destination Prefix ID (④) is entered.
- ⑥ Source ID** ..... Enter a station's source ID between 1 and 9999999. The ID is sent to the destinations. (Default: 311)



Microphone (MIC) screen

Connection Port Settings > Microphone (MIC)

## ■ Microphone Input Control

Edit the input setting of the microphone connected to the RoIP Gateway.

Microphone Input Control	
Microphone Voice	
Input Gain :	<input type="text" value="0"/> ▼ dB

**Input Gain** ..... Select the input gain for the microphone. (Default: 0)  
• Range: -12 ~ +6 (dB)

## Microphone (MIC) screen

Connection Port Settings > Microphone (MIC)

### ■ Voice Output Control

Edit the voice output control settings of the microphone connected to the RoIP Gateway.

**Voice Output Control**

---

Voice Volume

Output Gain : ① +40 ▼ dB

Notice Tone Volume : ② +30 ③ ▼ ④ dB

- |                                   |  |                |
|-----------------------------------|--|----------------|
| ① <b>Output Gain</b> .....        | Select the output gain for the microphone.<br>• Range: 0 ~ +63 (dB)        | (Default: +40) |
| ② <b>Notice Tone Volume</b> ..... | Adjust the Notice Tone volume.<br>• Range: 0 ~ +63 (dB)                    | (Default: +30) |
| ③ <b>&lt;Apply&gt;</b> .....      | Click to apply the settings.   |                |
| ④ <b>&lt;Reset&gt;</b> .....      | Click to reset the settings.<br>① You cannot reset after clicking <Apply>. |                |

## RoIP Gateway screen

Connection Port Settings > RoIP Gateway

### ■ RoIP Gateway

Set the Destination for the RoIP gateway connection.

RoIP Gateway	
RoIP Gateway Port :	RoIP Gateway1 <input type="button" value="v"/>

**RoIP Gateway Port** ..... Select a RoIP gateway port to edit the settings.  
(Default: RoIP Gateway1)

## RoIP Gateway screen

Connection Port Settings > RoIP Gateway

### ■ RoIP Gateway Connection

The settings for a destinations that are connected to the RoIP Gateway through the RoIP gateway connection.

**RoIP Gateway Connection**

---

Transmission Mode : ① Multicast ▼

Destination Address : ② 239.255.255.1

Destination Port Number : ③ 22510

Source Port Number : ④ 22510

Voice Protocol : ⑤ AMBE+2

⑥ \*Voice Protocol can be set on the Bridge Connection.

Multicast TTL : ⑦ 1

Connection Status : ⑧ Inactive Activate Refresh

① ⑥ is displayed only when the Transmission Mode (①) is set to "Multicast."

- ① **Transmission Mode** ..... Select the transmission mode used on the network, for devices connected to the RoIP Gateway.
  
- ② **Destination Address** ..... Enter the IP address or domain of the RoIP Gateway that going to be connected.  
When the Transmission Mode (①) is set to "Multicast," automatically set to "239.255.255.1."
  
- ③ **Destination Port Number** ..... Enter the same port number that entered to the Source Port Number (④) of the RoIP Gateway that going to be connected.  
  

(Default for RoIP Gateway1: 24400)  
 (Default for RoIP Gateway2: 24402)  
 (Default for RoIP Gateway3: 24404)  
 (Default for RoIP Gateway4: 24406)  
 (Default for RoIP Gateway5: 24408)  
 (Default for RoIP Gateway6: 24410)  
 (Default for RoIP Gateway7: 24412)  
 (Default for RoIP Gateway8: 24414)

  - ① Enter the port number between 2 and 65534, in even number.
  - ① Do not conflict with the other port settings.
  - ① In the Multicast mode, all the default setting are fixed to "25210."

## RoIP Gateway screen

### Connection Port Settings > RoIP Gateway

#### ■ RoIP Gateway Connection

**RoIP Gateway Connection**

Transmission Mode : ① Multicast ▼

Destination Address : ② 239.255.255.1

Destination Port Number : ③ 22510

Source Port Number : ④ 22510

Voice Protocol : ⑤ AMBE+2

\*Voice Protocol can be set on the Bridge Connection.

Multicast TTL : ⑥ 1

Connection Status : ⑦ Inactive Activate Refresh

⑥ is displayed only when the Transmission Mode (①) is set to "Multicast."

- ④ Source Port Number**      .....

Enter a port number to receive an audio signal.

  - ① Used as a source port number for an audio signal.
  - ① Enter a port number between 1024 and 65534, in even number.
  - ① Do not conflict with the other port settings.

(Default for RoIP Gateway1: 24400)  
 (Default for RoIP Gateway2: 24402)  
 (Default for RoIP Gateway3: 24404)  
 (Default for RoIP Gateway4: 24406)  
 (Default for RoIP Gateway5: 24408)  
 (Default for RoIP Gateway6: 24410)  
 (Default for RoIP Gateway7: 24412)  
 (Default for RoIP Gateway8: 24414)

  - ① Enter the port number between 2 and 65534, in even number.
  - ① Do not conflict with the other port settings.
  - ① In the Multicast mode, all the default setting are "25210."
- ⑤ Voice Protocol**      .....

Displays the Voice Protocol Selected in the "Voice Protocol (For Custom Bridge Connection)" (Bridge Connection Settings > Bridge Connection > AMBE+2 Vocoder Assignment > Voice Protocol (For Custom Bridge Connection))
- ⑥ Multicast TTL**      .....

Enter the Time to Live value (TTL). TTL is used to control the Multicast packet delivery scope. Every time the packets pass through the router, this value subtracted. When the value is "0," the packets are discarded. (Default: 1)

  - Range: 1 ~ 255
- ⑦ Connection Status**      .....

Click to connect or disconnect the RoIP Gateway, or to refresh the connection status.

  - ① The buttons are grayed out when Connected Repeater's Address is blank.
  - ① The settings cannot be changed while connection is established. Click <Deactivate> before changing the settings on this screen.



RoIP Gateway screen

Connection Port Settings > RoIP Gateway

## RoIP Gateway Communication

Edit settings for the connected RoIP Gateway to communicate.

- 1 Encryption** ..... Select whether or not to enable the Encryption function. (Default: Disable)  
 When you enable the function, enter an encryption key between 1 and 32767. (Default: 1)
- 2 TalkBack** ..... Select whether or not to enable the TalkBack function with devices connected to the RoIP Gateway. (Default: Enable)  
 When the function is enabled, Select the TalkBack time. (Default: 5)  
 • Range: 1 ~10 (seconds)
- 3 Call Type** ..... Select a call type. (Default: Group)  
 • Options: Individual, Group, or All
- 4 Destination Prefix ID** ..... Enter a destination prefix ID. The ID may differ, depending on the system. (Default: Blank)  
 • Range: 0 ~30
- 5 Destination ID** ..... Enter the default ID for the EXT port between 1 and 9999999. (Default: 1)  
 ⓘ Enter an ID between 00001 and 99999 when the Destination Prefix ID (4) is entered.
- 6 Source ID** ..... Enter a station's source ID between 1 and 9999999. The ID is sent to the destinations.  
 (Default for RoIP Gateway1: 801)  
 (Default for RoIP Gateway2: 802)  
 (Default for RoIP Gateway3: 803)  
 (Default for RoIP Gateway4: 804)  
 (Default for RoIP Gateway5: 805)  
 (Default for RoIP Gateway6: 806)  
 (Default for RoIP Gateway7: 807)  
 (Default for RoIP Gateway8: 808)

RoIP Gateway screen

Connection Port Settings > RoIP Gateway

## ■ RoIP Gateway Control

Edit settings for the connected RoIP Gateway to communicate.

RoIP Gateway Control	
Release Time :	<input type="text" value="200"/> milliseconds
*Setting value is set in five milliseconds steps.	

**Release Time** .....

Enter the period of time to detect the audio output stoppage to the RoIP Gateway. (Default: 200)

- Range: 5 ~ 2000 (milliseconds) in 5 second steps

## RoIP Gateway screen

Connection Port Settings > RoIP Gateway

### ■ Bridge Communication

The settings for the Bridge Communication when a Bridge Connection Destination is set to “Custom Bridge Connection.”  
(Bridge Connection Settings > Bridge Connection > Bridge Connection > Bridge Connection Destination)

- 1 Encryption** ..... Select whether or not to enable the Encryption function, depending on the connected transceiver's setting. (Default: Disable)  
When you enable the function, enter an encryption key between 1 and 32767. (Default: 1)
- 2 TalkBack** ..... Select whether or not to enable the TalkBack function with devices connected to the RoIP Gateway. (Default: Enable)  
When the function is enabled, Select the TalkBack time. (Default: 5)

  - Range: 1 ~ 10 (seconds)
- 3 Call Type** ..... Select a call type. (Default: Group)

  - Options: Individual, Group, or All
- 4 Destination Prefix ID** ..... Enter a destination prefix ID. The ID may differ, depending on the system.

  - Range: 0 ~30
- 5 Destination ID** ..... Enter an Individual or Group ID for the destination transceiver between 1 and 9999999. (Default: 1)

① Enter an ID between 00001 and 99999 when the Destination Prefix ID (4) is entered.
- 6 Source ID** ..... Enter the station's source ID between 1 and 9999999. Used for calling transceivers connected to the serial port. (Default: 1)
- 7 <Apply>** ..... Click to apply the settings.
- 8 <Reset>** ..... Click to reset the settings.

① You cannot reset after clicking <Apply>.

---

SelCall Number Converting screen .....	8-2
■ Save or Write the SelCall Number Converting Setting .....	8-2
■ About the SelCall Number Converting.....	8-3
■ SelCall Number Converting .....	8-4
■ List of SelCall Number Converting Entries .....	8-5
Destination Settings screen .....	8-6
■ Destination Settings (All) .....	8-6
■ Destination Settings (Group).....	8-9
■ Destination Settings (Talkgroup) .....	8-13
■ Destination Settings (Individual) .....	8-19
■ Destination Settings (Telephone) .....	8-21
■ List of Destination Setting Entries (All Call) .....	8-22
■ List of Destination Setting Entries (Group Call) .....	8-22
■ List of Destination Setting Entries (Talkgroup Call) .....	8-23
■ List of Destination Setting Entries (Multiplex Talkgroup Call) .....	8-24
■ List of Destination Setting Entries (Individual Call) .....	8-25
■ List of Destination Setting Entries (Telephone) .....	8-26
■ Destination Batch Setting .....	8-27

## SeiCall Number Converting screen

Destination Settings > SeiCall Number Converting

### ■ Save or Write the SeiCall Number Converting Setting

You can load or save the converting settings.

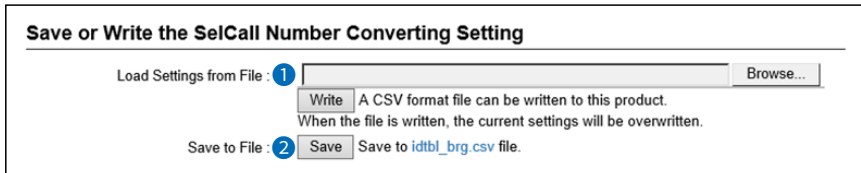

#### 1 Load Settings from File ...

You can load the saved [SeiCall Number Converting file] (Extension: csv) file, and write it to the RoIP Gateway. Click <Browse>, and select the SeiCall Number Converting file (Example: idtbl\_brg.csv) to load. Verify that the selected file is displayed, and then click <Write>.

- ① The content of the file is loaded to [List of SeiCall Number Converting Entries].
- ① When the setting file (Extension: sav) is used to restore the settings, the settings of the RoIP Gateway will be overwritten.

#### 2 Save to File .....

Click to save the [List of SeiCall Number Converting Entries] contents in the PC, as the "SeiCall Number Converting file (Extension: csv)."

SeiCall Number Converting screen

Destination Settings > SeiCall Number Converting

### About the SeiCall Number Converting

When a SeiCall number is shared beyond the site, you can't call transceivers across the site due to "SeiCall number duplication." The SeiCall Number Convert function solves this problem by automatically converting the SeiCall number.

Here is an example to show how the function works.

The transceiver (ID number: 1) in Area A is calling the transceiver (ID number: 2) in Area B using a provisionally assigned SeiCall number (9002).

The provisionally assigned SeiCall number is converted into the actual one (9002 to 2), according to the number conversion table. Therefore, they can talk to each other across the sites.

At the same time, the ID number of the transceiver in Area A is also converted, based on the list of SeiCall Number Converting entries registered in Area A's RoIP Gateway (1 to 8001). The converted number (8001) is displayed on the transceiver in Area B.

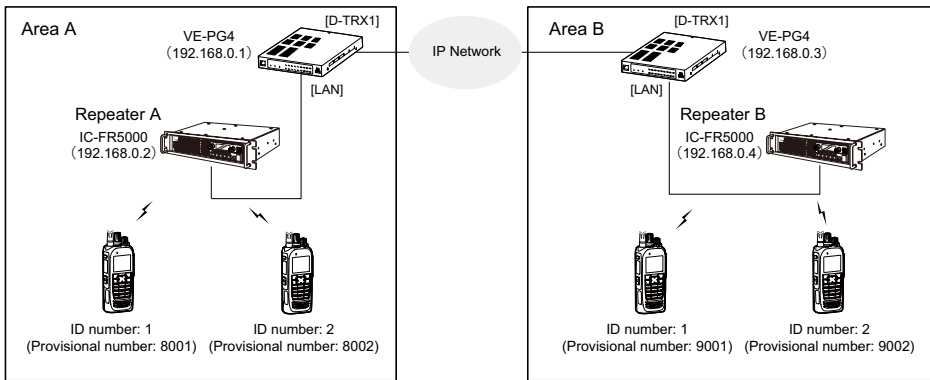

• The conversion table for the above example. (Area A)

List of SeiCall Number Converting Entries									
Index	Name	Destination			Convert Destination			Edit	Delete
		Call Type	Prefix ID	ID	Call Type	Prefix ID	ID		
1	Destination (Area B Sales Dept)	Individual		9001	Individual		1	Edit	Delete
2	Destination (Area B Sales Dept)	Individual		9002	Individual		2	Edit	Delete
3	Destination (Area A Sales Dept)	Individual		1	Individual		8001	Edit	Delete
4	Destination (Area A Sales Dept)	Individual		2	Individual		8002	Edit	Delete

• The conversion table for the above example. (Area B)

List of SeiCall Number Converting Entries									
Index	Name	Destination			Convert Destination			Edit	Delete
		Call Type	Prefix ID	ID	Call Type	Prefix ID	ID		
1	Destination (Area A Sales Dept)	Individual		8001	Individual		1	Edit	Delete
2	Destination (Area A Sales Dept)	Individual		8002	Individual		2	Edit	Delete
3	Destination (Area B Sales Dept)	Individual		1	Individual		9001	Edit	Delete
4	Destination (Area B Sales Dept)	Individual		2	Individual		9002	Edit	Delete

① We do not recommend using duplicate individual numbers between bases.

① You need to register both entries of the destination information and the source information.

SelCall Number Converting screen

Destination Settings > SelCall Number Converting

## SelCall Number Converting

Even when a SelCall number is shared in several sites, you can call a radio in a different site by using the provisionally assigned SelCall destination ID.

SelCall Number Converting								
Index ①	Name ②	Destination			Convert Destination			⑨
1		Call Type ③	Prefix ID ④	ID ⑤	Call Type ⑥	Prefix ID ⑦	ID ⑧	Add
		Individual			Individual			

- ① **Index** ..... The Index assigned for the entry. (Default: 1)  
Index range: 1 ~ 1000
- ② **Name** ..... Enter a name of up to 31 characters.
- ③ **Call Type (Destination)** ..... Select the type of call. (Default: Individual)
  - **Individual:** Virtually call a specified transceiver.
  - **Group:** Virtually call all transceivers that belong to the specified group.
  - **All:** Call all transceivers.
- ④ **Prefix ID (Destination)** ..... Enter the SelCall prefix ID.
  - Range: 0 ~ 30
- ⑤ **ID (Destination)** ..... Enter a provisionally assigned SelCall destination ID.  
ID range differs, Depending on the system mode.
  - ① When "All" is selected in [Call Type (Destination)] (③), This item's color changes to gray, and you cannot change the setting.
- ⑥ **Call Type (Convert Destination)** Select the call type. (Default: Individual)
  - **Individual:** Call only one transceiver.
  - **Group:** Call all transceivers that belong to the specified group.
  - **All:** Call all transceivers.
- ⑦ **Prefix ID (Convert Destination)** Enter the SelCall destination's prefix ID.
  - Range: 0 ~ 30
- ⑧ **ID (Convert Destination)** ... Enter the ID of the SelCall destination.  
ID range differs, Depending on the system mode.
  - ① When "All" is selected in [Call Type (Destination)] (③), this item's color changes to gray, and you cannot change the setting.
- ⑨ **<Add>** ..... Click to add the entry.
  - ① The registered contents are displayed on the [List of SelCall Number Converting Entries] screen.

SeiCall Number Converting screen

Destination Settings > SeiCall Number Converting

## List of SeiCall Number Converting Entries

Lists the SeiCall Number Converting settings.

List of SeiCall Number Converting Entries									
Index	Name	Destination			Convert Destination			1	2
		Call Type	Prefix ID	ID	Call Type	Prefix ID	ID		
1		Individual		9001	Individual		1	Edit	Delete
2		Individual		1	Individual		8001	Edit	Delete

Delete All

1 <Edit> .....

Click to edit the entry.  
 ⓘ The registered contents are displayed in [SeiCall Number Converting].

2 <Delete> .....

Click to delete the entry.  
 ⓘ You cannot restore after clicking <Delete>.

3 <Delete All> .....

Click to delete all of the entries.  
 ⓘ You cannot restore after clicking <Delete All>.



## Destination Settings screen

Destination Settings > Destination Settings

### Destination Settings (All)

The settings to call all the registered wireless LAN transceivers (IP100H/IP100FS). If necessary, you can include other bases connections, IP transceiver controllers, and transceiver ports. (Up to 22 locations, excluding the IP transceiver controller)

① This screen is displayed when clicking [Edit] of [List of Destination Setting Entries (All Call)].

This is an example of setting “All” as the Call Type.

① **Communication Type** ..... Select “Simplex” or “Full-Duplex.” (Default: Full-Duplex)

#### • Simplex operation

① When “Simplex” is selected, the called station cannot reply until the caller station stops transmitting.

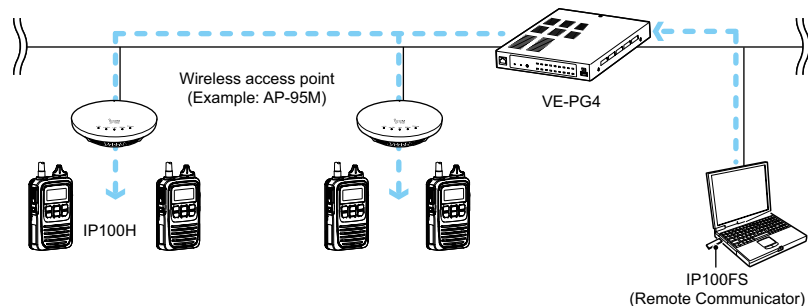

#### • Full-Duplex operation

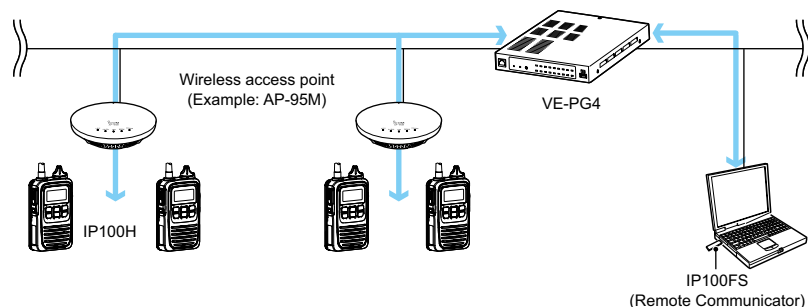

Destination Settings screen

Destination Settings > Destination Settings

■ Destination Settings (All)

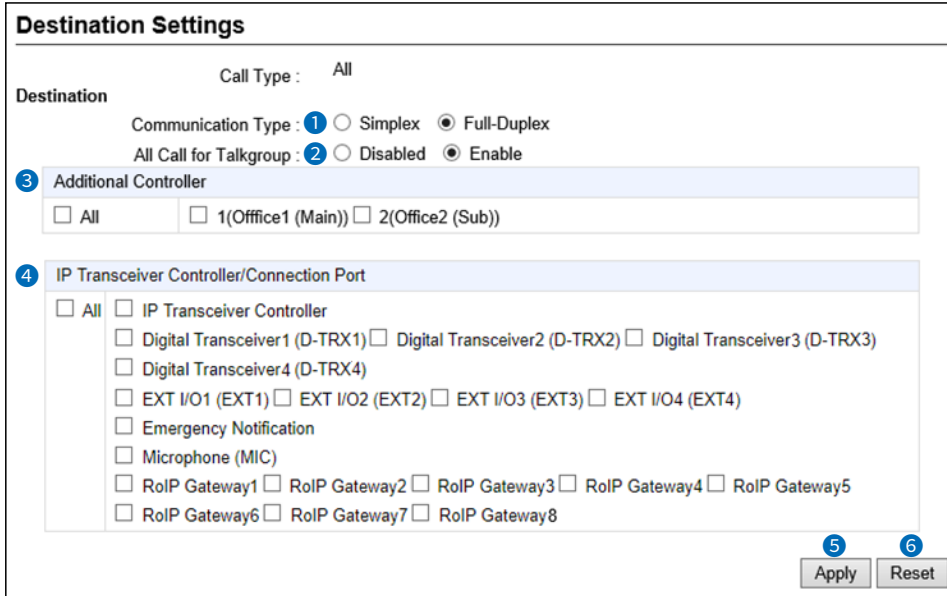

This is an example of setting “All” as the Call Type.

**2 All Call for Talkgroup** ..... Select whether or not the All call includes the wireless LAN transceivers that belong to the Talkgroup. (Default: Enable)

**3 Additional Controller** ..... Select the additional controller when configuring several controllers, and the All call calls between the different controllers.  
 ① By clicking “All,” you can select or cancel all entries in the list.  
 ① When “Sub” is selected in the [Additional Controller Settings] setting (Transceiver Controller > RoIP Settings > Additional Controller Settings), specify the master controller as the connection destination, as shown below.

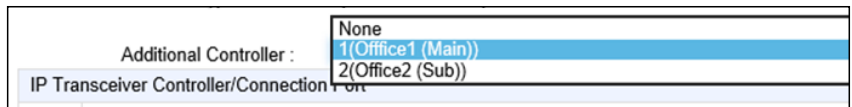

① The other bases in [Additional Controller] (3) and [IP Transceiver Controller/Connection Port] (4) can be connected to a total of up to 22 locations. (“IP Transceiver Controller” is not included this number of connections.) If you connect the other bases to more than 22 locations, you cannot communicate properly.

Destination Settings screen

Destination Settings > Destination Settings

■ Destination Settings (All)

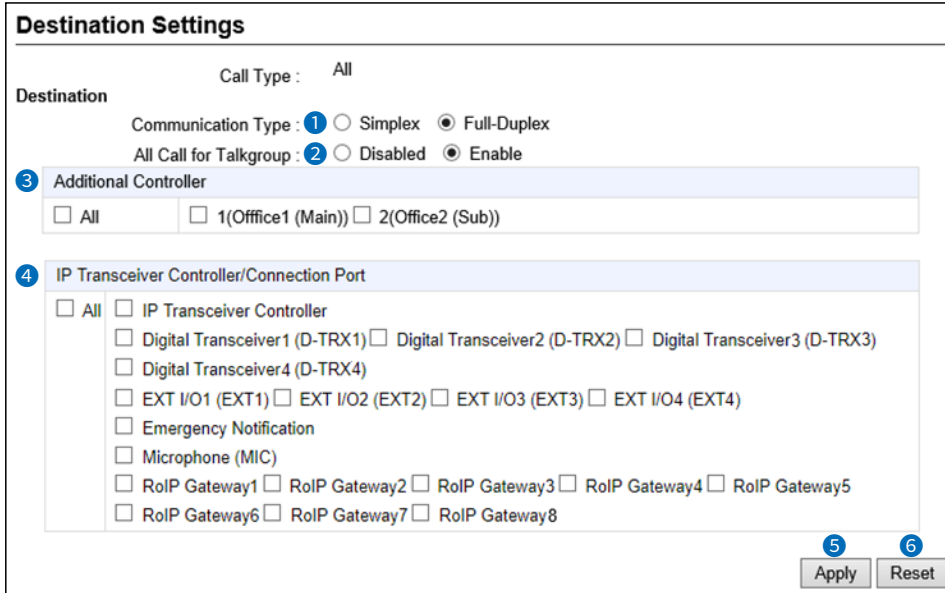

This is an example of setting “All” as the Call Type.

④ IP Transceiver Controller/  
Connection Port.....

Select the communication devices.

- **IP Transceiver Controller**\*1
- **Digital Transceiver1 (D-TRX1) ~ Digital Transceiver4 (D-TRX4)**
- **EXT I/O1 (EXT1) ~ EXT I/O4 (EXT4)**\*2
- **Emergency Notification**
- **Microphone (MIC)**
- **RoIP Gateway1 ~ RoIP Gateway8**

\*1 Displayed when an IP Transceiver Controller is connected.

\*2 When [Connected Unit] is set to “EXT I/O Unit” and [EXT I/O Port Mode] is set to “Separate” in [EXT I/O Port Mode] setting (Connection Port Settings > EXT I/O (EXT) > EXT I/O Port Mode), “EXT Input” and “EXT Output” are displayed.

① When clicking “All,” you can select or cancel all at once.

① When a speaker microphone is connected to the [MIC] port, the audio input/output of the [EXT1] port is disconnected.  
The Audio input/output of the [MIC] port and the [EXT1] port cannot be used at the same time.

① The other bases in [Additional Controller] (③) and [IP Transceiver Controller/Connection Port] (④) can be connected to a total of up to 22 locations. (“IP Transceiver Controller” is not included this number of connections.)  
If you connect the other bases to more than 22 locations, you cannot communicate properly.

⑤ <Apply> .....

Click to apply the entries.

① The registered contents are displayed in [List of Destination Setting Entries (All Call)].

⑥ <Reset> .....

Click to reset the settings.

① You cannot reset after clicking <Apply>

Destination Settings screen

Destination Settings > Destination Settings

## Destination Settings (Group)

The settings to call the registered group through the IP network or the RoIP Gateway's transceiver port.

① The displayed contents are changed according to the Call Type.

**Destination Settings**

No. : ① 10

Name : ②

Call Type : ③ Group

Destination ID : ④ 0001

Group Priority : ⑤  Normal  High

Destination

Communication Type : ⑥  Simplex  Full-Duplex

This is an example of setting "Group" as the Call Type (③).

- ① **No.** ..... Select the number to register the destination Group.  
Up to 1990 destinations can be registered.
  - ② **Name** ..... Enter a destination name of up to 31 characters.
  - ③ **Call Type** ..... Select "Group" for Group calls.
  - ④ **Destination ID** ..... Enter a 4 digit destination number.  
• Range: 0001 ~ 9999
  - ⑤ **Group Priority** ..... Select "Normal" or "High" to set the priority in the Group call.  
(Default: Normal)
- ① This item can be selected when "Group" is selected in [Call Type] (③).

Destination Settings screen

Destination Settings > Destination Settings

Destination Settings (Group)

Destination Settings	
No. :	1 10
Name :	2
Call Type :	3 Group
Destination ID :	4 0001
Group Priority :	5 <input checked="" type="radio"/> Normal <input type="radio"/> High
Destination	
Communication Type :	6 <input type="radio"/> Simplex <input checked="" type="radio"/> Full-Duplex

This is an example of setting "Group" as the Call Type (3).

6 Communication Type ..... Select "Simplex" or "Full-Duplex." (Default: Full-Duplex)

• Simplex operation

① When "Simplex" is selected, the called station cannot reply until the caller station stops transmitting.

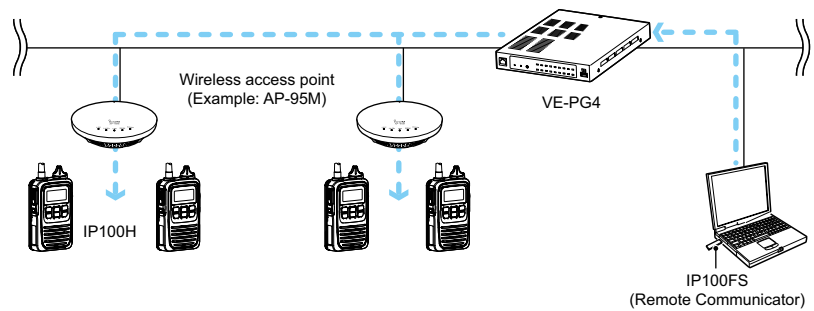

• Full-Duplex operation

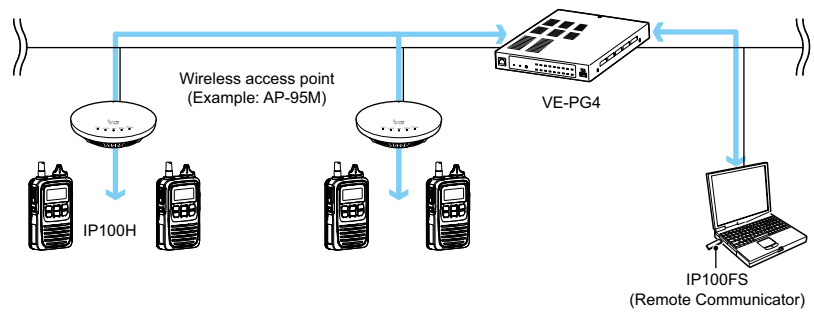

Destination Settings screen

Destination Settings > Destination Settings

■ Destination Settings (Group)

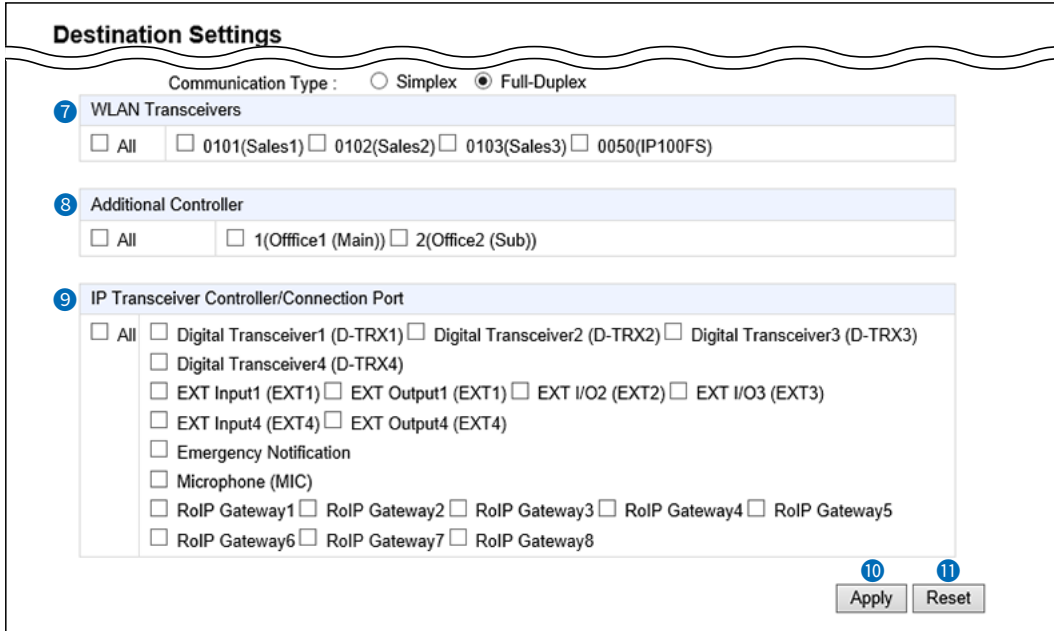

This is an example of setting “Group” as the Call Type (3).

7 WLAN Transceivers .....

Select the IP100H and IP100FS that belong the group from the list.  
 ① The WLAN transceivers added in [Transceiver Registration] are displayed.  
 ① By clicking “All,” you can select or cancel all at once.

8 Additional Controller .....

Select an additional controller when configuring several controllers, and the Group call calls between the different controllers.  
 ① By clicking “All,” you can select or cancel all entries in the list.  
 ① When “Sub” is selected in the [Additional Controller Settings] setting (Transceiver Controller > RoIP Settings > Additional Controller Settings), specify the master controller as the connection destination, as shown below.

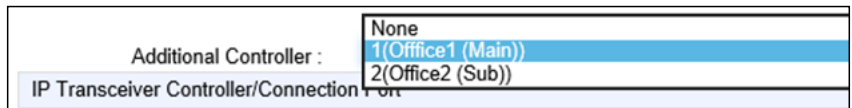

① The other bases in [Additional Controller] (8) and [IP Transceiver Controller/Connection Port] (9) can be connected to a total of up to 22 locations. (“IP Transceiver Controller” is not included in this number of connections.) If you connect other bases to more than 22 locations, you cannot communicate properly.

**NOTE:** When you use the Additional Controller Link function, set the other bases to be paired in the [Area Entry List] setting (Transceiver Controller > RoIP Server Settings > Area Call > Area Entry List). For example, when the destination setting of Group 1 in the additional Controller 1 is set to additional Controller 2, the destination setting of Group 1 in the additional Controller 2 must be set to additional Controller 1.  
 ① The same applies in the case when the connection configuration between the other bases consists of the master controller and the multiple sub controllers.

Destination Settings screen

Destination Settings > Destination Settings

■ Destination Settings (Group)

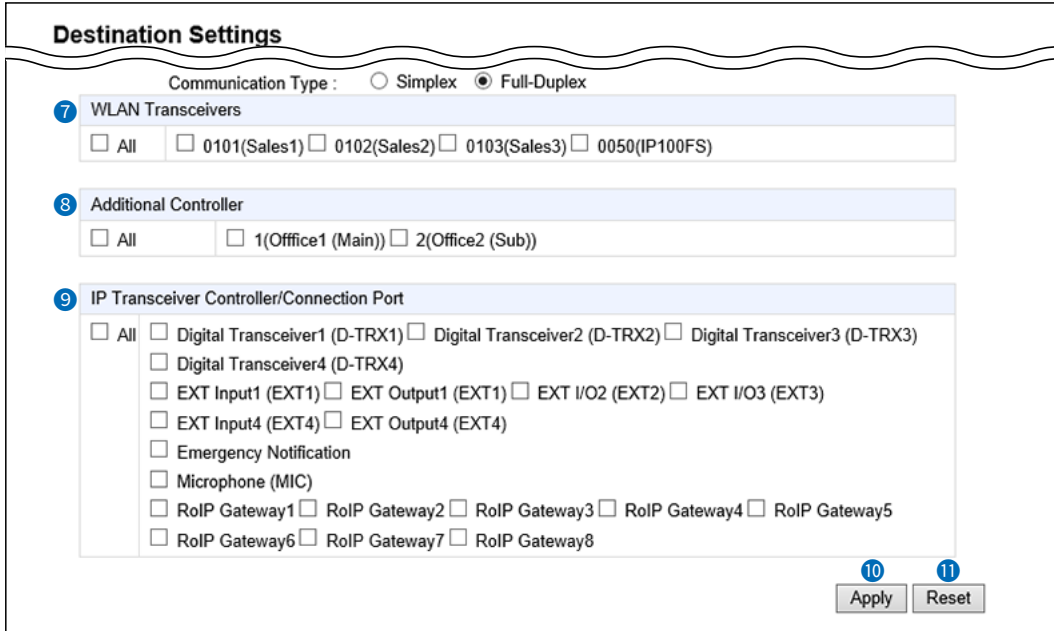

This is an example of setting “Group” as the Call Type (③).

⑨ IP Transceiver Controller/ Connection Port.....

Select the communication devices.

- IP Transceiver Controller\*1
- Digital Transceiver1 (D-TRX1) ~ Digital Transceiver4 (D-TRX4)
- EXT I/O1 (EXT1) ~ EXT I/O4 (EXT4)\*2
- Emergency Notification
- Microphone (MIC)
- RoIP Gateway1 ~ RoIP Gateway8

\*1 Displayed when an IP Transceiver Controller is connected.

\*2 When [Connected Unit] is set to “EXT I/O Unit” and [EXT I/O Port Mode] is set to “Separate” in [EXT I/O Port Mode] setting (Connection Port Settings > EXT I/O (EXT) > EXT I/O Port Mode), “EXT Input” and “EXT Output” are displayed.

① By clicking “All,” you can select or cancel all at once.

① When a speaker microphone is connected to the [MIC] port, the audio input/output of the [EXT1] port is disconnected. The Audio input/output of the [MIC] port and the [EXT1] port cannot be used at the same time.

① The other bases in [Additional Controller] (⑧) and [IP Transceiver Controller/ Connection Port] (⑨) can be connected to a total of up to 22 locations. (“IP Transceiver Controller” is not included this number of connections.) If you connect the other bases to more than 22 locations, you cannot communicate properly.

① For the EXT port that the IC-SAT100 is connected, you can belong to only a Group or Talkgroup.

⑩ <Apply> .....

Click to apply the entries.

① The registered contents are displayed in [List of Destination Setting Entries (Group Call)].

⑪ <Reset> .....

Click to reset the settings.

① You cannot reset after clicking <Apply>.

Destination Settings screen

Destination Settings > Destination Settings

## Destination Settings (Talkgroup)

The settings to call the registered Talkgroup through the IP network or the RoIP Gateway's transceiver port.  
 ① The displayed contents are changed according to the Call Type.

**Destination Settings**

No. : ① 1

Name : ②

Call Type : ③ Talkgroup

Destination ID : ④ 0001

Talkgroup Type : ⑤  Normal  Multiplex Talkgroup

**Destination**

Communication Type : ⑥  Simplex  Full-Duplex

Talkgroup Call for IP100FS : ⑦  Disabled  Enable

Callee ID for IP100FS : ⑧  All  Appointment

Destination ID : \_\_\_\_\_

This is an example of setting “Talkgroup” as the Call Type (③), and “Appointment” as the Callee ID for IP100FS (⑧).

- ① **No.** ..... Select the number to register the destination Talkgroup.  
Up to 1990 destinations can be registered.
- ② **Name** ..... Enter a destination name of up to 31 characters.
- ③ **Call Type** ..... Select “Talkgroup” for Talkgroup calls.
- ④ **Destination ID** ..... Enter a 4 digit destination number.  
Range: 0001 ~ 9999  
 ① This number must also be registered in the [ID List] setting (Transceiver Controller > Common Settings > ID List > ID List).  
 ① When “FUNC Key” in the [Talkgroup Selection] setting (Transceiver Controller > Common Settings > Profile > Profile > Talkgroup Selection) is selected, the wireless LAN transceiver can call to members in the same Talkgroup.  
Select “OFF” on the wireless LAN transceiver to return to the usual standby mode screen.

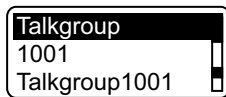

Talkgroup is selected

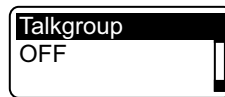

Talkgroup is OFF

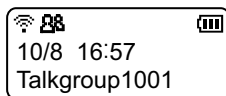

Talkgroup is selected

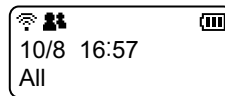

Talkgroup is OFF



Destination Settings screen

Destination Settings > Destination Settings

Destination Settings (Talkgroup)

**Destination Settings**

---

No.: 1

Name:

Call Type: Talkgroup

Destination ID: 0001

Talkgroup Type:  Normal  Multiplex Talkgroup

**Destination**

Communication Type:  Simplex  Full-Duplex

Talkgroup Call for IP100FS:  Disabled  Enable

Callee ID for IP100FS:  All  Appointment

Destination ID:

This is an example of setting “Talkgroup” as the Call Type (3), and “Appointment” as the Callee ID for IP100FS (8).

5 Talkgroup Type .....

When “Multiplex Talkgroup” is selected, you can talk to multiple Talkgroups.

Talkgroup Type :  Normal  Multiplex Talkgroup

Linked Talkgroup				
v	v	v	v	v
v	v	v	v	v

- ① This setting can be selected when “Talkgroup” is selected in Call Type (3).
- ① You cannot register the Multiplex Talkgroup in other Multiplex Talkgroups.
- ① The normal Talkgroup can only belong to 1 Multiplex Talkgroup.

Example: When Talkgroup1002 (Normal) and Talkgroup1003 (Normal) belong to Talkgroup1001 (Multiplex).

- Talkgroup1001 can call to Talkgroup1001, Talkgroup1002, and Talkgroup1003.
- Talkgroup1002 can call to Talkgroup1001 and Talkgroup1002.
- Talkgroup1003 can call to Talkgroup1001 and Talkgroup1003.

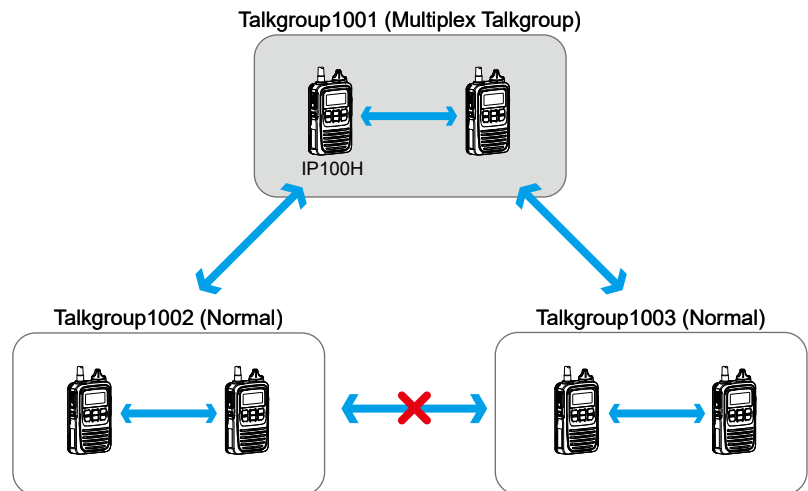

## Destination Settings screen

### Destination Settings > Destination Settings

#### Destination Settings (Talkgroup)

**Destination Settings**

No.: 1

Name:

Call Type: Talkgroup

Destination ID: 0001

Talkgroup Type:  Normal  Multiplex Talkgroup

**Destination**

Communication Type:  Simplex  Full-Duplex

Talkgroup Call for IP100FS:  Disabled  Enable

Callee ID for IP100FS:  All  Appointment

Destination ID:

This is an example of setting “Talkgroup” as the Call Type (3), and “Appointment” as the Callee ID for IP100FS (8).

**6 Communication Type** ..... Select “Simplex” or “Full-Duplex.” (Default: Full-Duplex)

#### • Simplex operation

① When “Simplex” is selected, the called station cannot reply until the caller station stops transmitting.

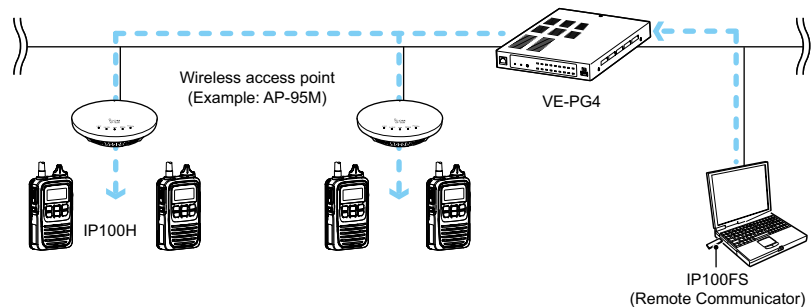

#### • Full-Duplex operation

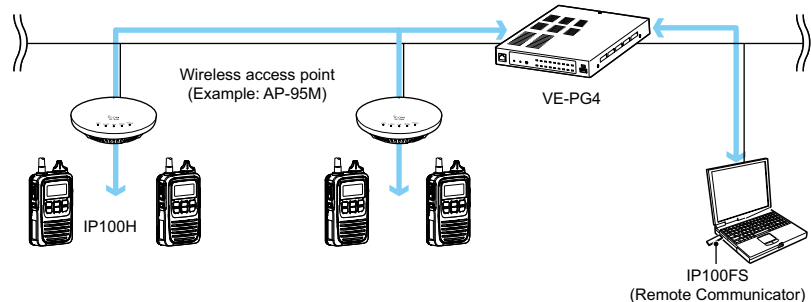

**7 Talkgroup Call for IP100FS...** Select whether or not the Talkgroup Call includes the IP100FS. (Default: Enable)

**8 Callee ID for IP100FS** ..... Select the IP100FS to be called when “Enable” is selected in [Talkgroup Call for IP100FS] (7). (Default: All)

① When “Appointment” is selected, you can register up to 5 IP100FS’s destination IDs (4digits).

① This item is not displayed when “Disabled” is selected in [Talkgroup Call for IP100FS] (7).

① In the Multiplex Talkgroup, the settings for the IP100FS must be the same for all the Talkgroups.

Destination Settings screen

Destination Settings > Destination Settings

■ Destination Settings (Talkgroup)

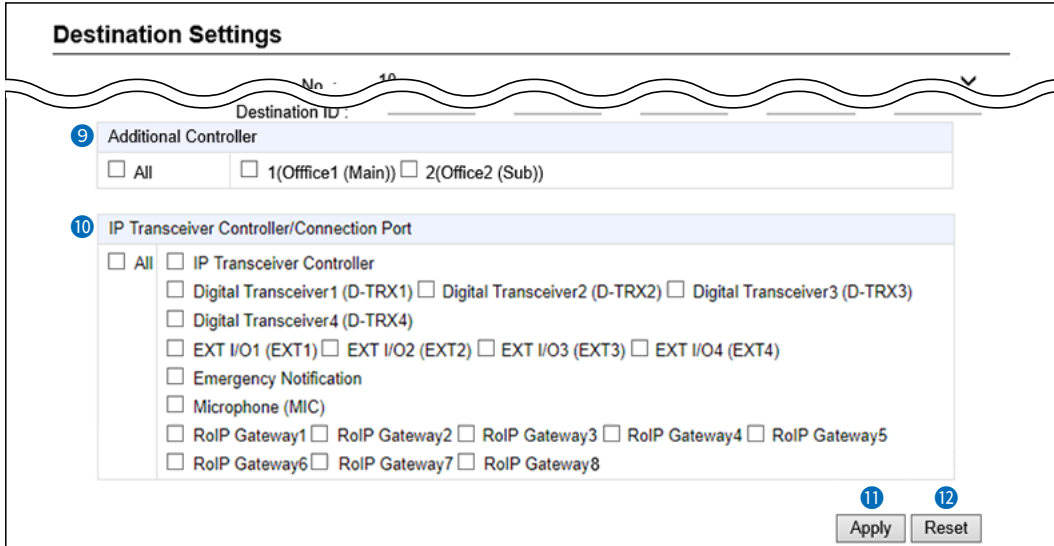

This is an example of setting “Talkgroup” as the Call Type (3).

9 Additional Controller .....

Select the additional controller when configuring several controllers, and the Talkgroup call calls between the different controllers.

- ① By clicking “All,” you can select or cancel all entries in the list.
- ① When “Sub” is selected in the [Additional Controller Settings] setting

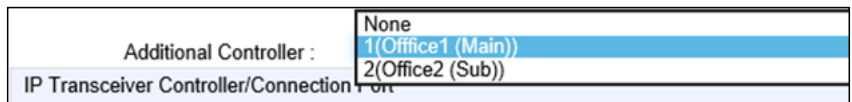

(Transceiver Controller > RoIP Settings > Additional Controller Settings), specify the master controller as the connection destination, as shown below.

① The other bases in [Additional Controller] (9) and [IP Transceiver Controller/Connection Port] (10) can be connected to a total of up to 22 locations. (“IP Transceiver Controller” is not included this number of connections.) If you connect the other bases to more than 22 locations, you cannot communicate properly.

Destination Settings screen

Destination Settings > Destination Settings

■ Destination Settings (Talkgroup)

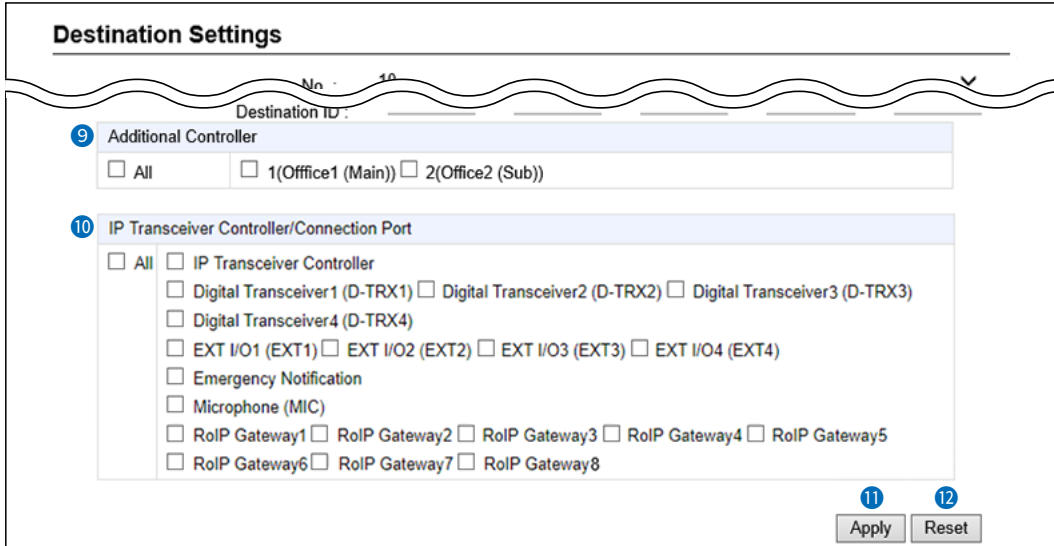

This is an example of setting “Talkgroup” as the Call Type (③).

⑩ IP Transceiver Controller/  
Connection Port.....

Select the communication devices.

- **IP Transceiver Controller\*1**
- **Digital Transceiver1 (D-TRX1) ~ Digital Transceiver4 (D-TRX4)**
- **EXT I/O1 (EXT1) ~ EXT I/O4 (EXT4)\*2**
- **Emergency Notification**
- **Microphone (MIC)**
- **RoIP Gateway1 ~ RoIP Gateway8**

\*1 Displayed when an IP Transceiver Controller is connected.

\*2 When [Connected Unit] is set to “EXT I/O Unit” and [EXT I/O Port Mode] is set to “Separate” in [EXT I/O Port Mode] setting (Connection Port Settings > EXT I/O (EXT) > EXT I/O Port Mode), “EXT Input” and “EXT Output” are displayed.

① By clicking “All,” you can select or cancel all at once.

① When a speaker microphone is connected to the [MIC] port, the audio input/output of the [EXT1] port is disconnected.

The Audio input/output of the [MIC] port and the [EXT1] port cannot be used at the same time.

① The other bases in [Additional Controller] (⑨) and [IP Transceiver Controller/Connection Port] (⑩) can be connected to a total of up to 22 locations. (“IP Transceiver Controller” is not included this number of connections.)

If you connect the other bases to more than 22 locations, you cannot communicate properly.

Destination Settings screen

Destination Settings > Destination Settings

■ Destination Settings (Talkgroup)

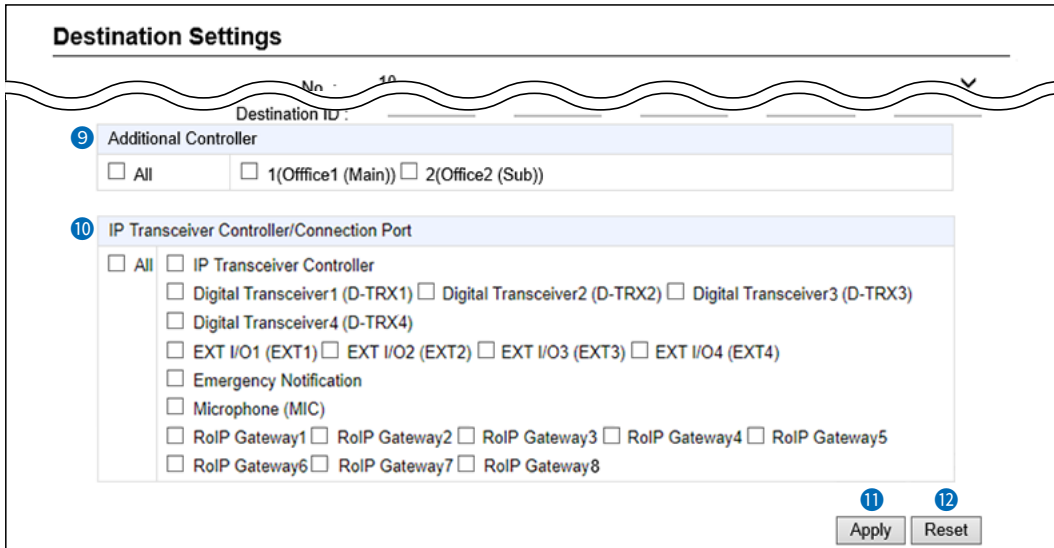

This is an example of setting “Talkgroup” as the Call Type (3).

11 <Apply> ..... Click to apply the entries.

• **When “Normal” is selected in the Talkgroup Type**  
The entries are displayed in [List of Destination Setting Entries (Talkgroup Call)].

• **When “Multiplex Talkgroup” is selected in the Talkgroup Type**  
The entries are displayed in [List of Destination Setting Entries (Multiplex Talkgroup Call)].

12 <Reset> ..... Click to reset the settings.

① You cannot reset after clicking <Apply>.

Destination Settings screen

Destination Settings > Destination Settings

### Destination Settings (Individual)

The settings to call the registered destination station through the IP network or the RoIP Gateway's transceiver port.  
 ① The displayed contents are changed according to the Call Type.

**Destination Settings**

No. : ① 1

Name : ②

Call Type : ③ Individual

Destination ID : ④ 0001

**Destination**

Additional Controller/IP Transceiver Controller/Connection Port : ⑤ None

⑥ Apply ⑦ Reset

This is an example of setting "Individual" as the Call Type (③).

- ① **No.** ..... Select the number to register the destination station.  
Up to 1990 destinations can be registered.
- ② **Name** ..... Enter a destination name of up to 31 characters.
- ③ **Call Type** ..... Select "Individual" for Individual calls.
- ④ **Destination ID** ..... Enter a 4 digit destination number.  
• Range: 0001 ~ 9999

Destination Settings screen

Destination Settings > Destination Settings

■ Destination Settings (Individual)

This is an example of setting “Individual” as the Call Type (3).

5 Additional Controller/IP Transceiver

Controller/Connection Port ...

Select the communication devices or the path.

- None
- Additional Controller\*1
- IP Transceiver Controller\*2
- Digital Transceiver1 (D-TRX1) ~ Digital Transceiver4 (D-TRX4)
- EXT I/O1 (EXT1) ~ EXT I/O4 (EXT4)\*3
- Emergency Notification
- Microphone (MIC)
- RoIP Gateway1 ~ RoIP Gateway8

\*1 The registered additional controllers are displayed.

\*2 Displayed when an IP Transceiver Controller is connected.

\*3 When [Connected Unit] is set to “EXT I/O Unit” and [EXT I/O Port Mode] is set to “Separate” in the [EXT I/O Port Mode] setting (Connection Port Settings > EXT I/O (EXT) > EXT I/O Port Mode), “EXT Input” and “EXT Output” are displayed.

① When a speaker microphone is connected to the [MIC] port, the audio input/output of the [EXT1] port is disconnected.  
The Audio input/output of the [MIC] port and the [EXT1] port cannot be used at the same time.

6 <Apply> .....

Click to apply the entries.

① The registered contents are displayed in [List of Destination Setting Entries (Individual Call)].

7 <Reset> .....

Click to reset the settings.

① You cannot reset after clicking <Apply>.

Destination Settings screen

Destination Settings > Destination Settings

## Destination Settings (Telephone)

The settings to call the registered telephone through the IP network.

① The displayed contents are changed according to the Call Type.

The screenshot shows a web interface titled "Destination Settings". It contains the following elements:
 

- A dropdown menu for "No." with the value "1" selected, marked with a circled 1.
- A text input field for "Name", marked with a circled 2.
- A dropdown menu for "Call Type" with "Telephone" selected, marked with a circled 3.
- A text input field for "Destination Phone Number", marked with a circled 4.
- Two buttons at the bottom right: "Apply" (marked with a circled 5) and "Reset" (marked with a circled 6).

This is an example of setting "Telephone" as the Call Type (3).

- ① **No.** ..... Select the number to register the destination station.  
Up to 1990 destinations can be registered.
- ② **Name** ..... Enter a destination name of up to 31 characters.
- ③ **Call Type** ..... Select "Telephone" for Telephone calls.  
① This Call Type includes the transceivers connected by the Bridge Connection through a VE-PG4.
- ④ **Destination Phone Number...** Enter a destination phone number of up to 31 digit numbers and characters (# or \*).
- ⑤ **<Apply>** ..... Click to apply the entries.  
① The registered contents are displayed in [List of Destination Setting Entries (Telephone)].
- ⑥ **<Reset>** ..... Click to reset the settings.  
① You cannot reset after clicking <Apply>.



Destination Settings screen

Destination Settings > Destination Settings

### List of Destination Setting Entries (All Call)

Lists the destination setting entries for All Calls.

① Click <Edit> to edit the entry.

List of Destination Setting Entries (All Call)			
Communication Type	All Call for Talkgroup	Additional Controller	IP Transceiver Controller/Connection Port
Full-Duplex	Enable	-	Not Set

Destination Settings > Destination Settings

### List of Destination Setting Entries (Group Call)

Lists the destination setting entries for Group Calls.

List of Destination Setting Entries (Group Call)							
<input type="checkbox"/> All	No.	Name	Destination ID	Group Priority	Number of WLAN Transceivers	Additional Controller	IP Transceiver Controller/Connection Port
<input type="checkbox"/>	2	Sales	0001	Normal	-	-	Set

- ① Check Box** ..... Click to add a check mark to delete the entry.  
 ① By clicking <All>, you can select or cancel all the entries.
- ② <Edit>** ..... Click to edit the entry.
- ③ <Delete>** ..... Click to delete the entry.  
 ① You cannot restore after clicking <Delete>.
- ④ <Delete Selected>** ..... Click to delete the selected entries.  
 ① You cannot restore after clicking <Delete Selected>.
- ⑤ <Delete All>** ..... Click to delete all of the entries.  
 ① You cannot restore after clicking <Delete All>.

Destination Settings screen

Destination Settings > Destination Settings

### List of Destination Setting Entries (Talkgroup Call)

Lists the destination setting entries for Talkgroup Calls.

List of Destination Setting Entries (Talkgroup Call)						
1 <input type="checkbox"/> All	No.	Name	Destination ID	Additional Controller	IP Transceiver Controller/Connection Port	2 3
<input type="checkbox"/>	3		1002	-	Not Set	Edit Delete
<input type="checkbox"/>	4		1003	-	Not Set	Edit Delete

4 5  
Delete Selected Delete All

- 1 **Check Box** ..... Click to add a check mark to delete the entry.  
 ⓘ By clicking <All>, you can select or cancel all the entries.
- 2 **<Edit>** ..... Click to edit the entry.
- 3 **<Delete>** ..... Click to delete the entry.  
 ⓘ You cannot restore after clicking <Delete>.
- 4 **<Delete Selected>** ..... Click to delete the selected entries.  
 ⓘ You cannot restore after clicking <Delete Selected>.
- 5 **<Delete All>** ..... Click to delete all of the entries.  
 ⓘ You cannot restore after clicking <Delete All>.

Destination Settings screen

Destination Settings > Destination Settings

## ■ List of Destination Setting Entries (Multiplex Talkgroup Call)

Lists the destination setting entries for Multiplex Talkgroup Calls.

List of Destination Setting Entries (Multiplex Talkgroup Call)							
1	<input type="checkbox"/> All	No.	Name	Destination ID	Talkgroup Selection	2	3
	<input type="checkbox"/>	5		1004	1002 1003	Edit	Delete
						4	5
						Delete Selected	Delete All

- 1 Check Box** ..... Click to add a check mark to delete the entry.  
 ⓘ By clicking <All>, you can select or cancel all the entries.
- 2 <Edit>** ..... Click to edit the entry.
- 3 <Delete>** ..... Click to delete the entry.  
 ⓘ You cannot restore after clicking <Delete>.
- 4 <Delete Selected>** ..... Click to delete the selected entries.  
 ⓘ You cannot restore after clicking <Delete Selected>.
- 5 <Delete All>** ..... Click to delete all of the entries.  
 ⓘ You cannot restore after clicking <Delete All>.

Destination Settings screen

Destination Settings > Destination Settings

### List of Destination Setting Entries (Individual Call)

Lists the destination setting entries for Individual Calls.

List of Destination Setting Entries (Individual Call)						
1	<input type="checkbox"/> All	No.	Name	Destination ID	Additional Controller/IP Transceiver Controller/Connection Port	2 3
	<input type="checkbox"/>	1970	Digital Transceiver1 (D-TRX1)	0201	Digital Transceiver1 (D-TRX1)	Edit Delete
	<input type="checkbox"/>	1971	Digital Transceiver2 (D-TRX2)	0202	Digital Transceiver2 (D-TRX2)	Edit Delete
	<input type="checkbox"/>	1972	Digital Transceiver3 (D-TRX3)	0203	Digital Transceiver3 (D-TRX3)	Edit Delete
	<input type="checkbox"/>	1973	Digital Transceiver4 (D-TRX4)	0204	Digital Transceiver4 (D-TRX4)	Edit Delete
	<input type="checkbox"/>	1974	EXT Input1 (EXT1)	0351	-	Edit Delete
	<input type="checkbox"/>	1975	EXT Output1 (EXT1)	0301	EXT I/O1 (EXT1)	Edit Delete
	<input type="checkbox"/>	1976	EXT Input2 (EXT2)	0352	-	Edit Delete
	<input type="checkbox"/>	1977	EXT Output2 (EXT2)	0302	EXT I/O2 (EXT2)	Edit Delete
	<input type="checkbox"/>	1978	EXT Input3 (EXT3)	0353	EXT Input3 (EXT3)	Edit Delete
	<input type="checkbox"/>	1979	EXT Output3 (EXT3)	0303	EXT Output3 (EXT3)	Edit Delete
	<input type="checkbox"/>	1980	EXT Input4 (EXT4)	0354	EXT Input4 (EXT4)	Edit Delete
	<input type="checkbox"/>	1981	EXT Output4 (EXT4)	0304	EXT Output4 (EXT4)	Edit Delete
	<input type="checkbox"/>	1982	Microphone (MIC)	0311	Microphone (MIC)	Edit Delete
	<input type="checkbox"/>	1983	RoIP Gateway1	0801	RoIP Gateway1	Edit Delete
	<input type="checkbox"/>	1984	RoIP Gateway2	0802	RoIP Gateway2	Edit Delete
	<input type="checkbox"/>	1985	RoIP Gateway3	0803	RoIP Gateway3	Edit Delete
	<input type="checkbox"/>	1986	RoIP Gateway4	0804	RoIP Gateway4	Edit Delete
	<input type="checkbox"/>	1987	RoIP Gateway5	0805	RoIP Gateway5	Edit Delete
	<input type="checkbox"/>	1988	RoIP Gateway6	0806	RoIP Gateway6	Edit Delete
	<input type="checkbox"/>	1989	RoIP Gateway7	0807	RoIP Gateway7	Edit Delete
	<input type="checkbox"/>	1990	RoIP Gateway8	0808	RoIP Gateway8	Edit Delete

4 5  
Delete Selected Delete All

① The screen above shows the default settings.

- 1 **Check Box** ..... Click to add a check mark to delete the entry.  
① By clicking <All>, you can select or cancel all the entries.
- 2 **<Edit>** ..... Click to edit the entry.
- 3 **<Delete>** ..... Click to delete the entry.  
① You cannot restore after clicking <Delete>.
- 4 **<Delete Selected>** ..... Click to delete the selected entries.  
① You cannot restore after clicking <Delete Selected>.
- 5 **<Delete All>** ..... Click to delete all of the entries.  
① You cannot restore after clicking <Delete All>.

Destination Settings screen

Destination Settings > Destination Settings

### List of Destination Setting Entries (Telephone)

Lists the destination setting entries for Telephone Calls.

List of Destination Setting Entries (Telephone)				
<input type="checkbox"/> All	No.	Name	Destination Phone Number	
<input type="checkbox"/>	6	UT136-31	31	<input type="button" value="Edit"/> <input type="button" value="Delete"/>
<input type="checkbox"/>	7	UT136-32	32	<input type="button" value="Edit"/> <input type="button" value="Delete"/>
			<input type="button" value="Delete Selected"/>	<input type="button" value="Delete All"/>

- 1 Check Box** ..... Click to add a check mark to delete the entry.  
 ① By clicking <All>, you can select or cancel all the entries.
- 2 <Edit>** ..... Click to edit the entry.
- 3 <Delete>** ..... Click to delete the entry.  
 ① You cannot restore after clicking <Delete>.
- 4 <Delete Selected>** ..... Click to delete the selected entries.  
 ① You cannot restore after clicking <Delete Selected>.
- 5 <Delete All>** ..... Click to delete all of the entries.  
 ① You cannot restore after clicking <Delete All>.

Destination Settings screen

Destination Settings > Destination Settings

### Destination Batch Setting

In this settings, you can register the Destination IDs all at once by serial number, or copy the registered settings to other destinations.

- 1 **Call Type** ..... Select the Call Type from “Individual,” “Group,” or “Talkgroup.”
- 2 **Destination ID** ..... Enter the range of Destination ID number.
  - **<Add>**  
By clicking <Add> after [Refer to] (3) is set, the entered Destination ID range is registered to the selected reference.
  - ① When the entered Destination ID number is already registered. “Override the settings” is displayed.
- 3 **Refer to** ..... Select the registered setting for reference.

---

Emergency Notification screen .....	9-2
■ Emergency Notification .....	9-2
Abnormal Condition Monitoring screen.....	9-3
■ LAN Port Link-down .....	9-3
■ PING Test .....	9-4
■ SIP Server Registration .....	9-5
IP Transceiver Status Filtering screen .....	9-6
■ IP Transceiver Status Filtering .....	9-6
■ Filtering List .....	9-7
■ Filtering List Batch Setting .....	9-8
Connection Port Extension screen .....	9-9
■ VoIP Settings .....	9-9
Call Recording screen .....	9-12
■ Common Setting .....	9-12
■ Recorder Setting .....	9-13
■ List of Recording Box Entries .....	9-15

## Emergency Notification screen

Expert Settings > Emergency Notification

### Emergency Notification

Select the port to use as the emergency notice output.

**Emergency Notification**

Digital Transceiver1 (D-TRX1):  Disable  Enable

Digital Transceiver2 (D-TRX2):  Disable  Enable

Digital Transceiver3 (D-TRX3):  Disable  Enable

Digital Transceiver4 (D-TRX4):  Disable  Enable

EXT I/O1 (EXT1):  Disable  Enable

EXT I/O2 (EXT2):  Disable  Enable

EXT Output3 (EXT3):  Disable  Enable

EXT Output4 (EXT4):  Disable  Enable

Emergency Notification Equipment:  Disable  Enable

Microphone(MIC):  Disable  Enable

RolP Gateway 1:  Disable  Enable

RolP Gateway 2:  Disable  Enable

RolP Gateway 3:  Disable  Enable

RolP Gateway 4:  Disable  Enable

RolP Gateway 5:  Disable  Enable

RolP Gateway 6:  Disable  Enable

RolP Gateway 7:  Disable  Enable

RolP Gateway 8:  Disable  Enable

- 1 Digital Transceiver** ..... Select whether or not to send an emergency notice to the D-TRX1 ~ D-TRX4 ports. (Default: Disable)
- 2 EXT I/O / EXT Output** ..... Select whether or not to send an emergency notice to transceivers or devices connected to the EXT I/O ports. (Default: Disable)

① “EXT Output” is displayed when the “Connected Unit” is set to “EXT I/O Unit,” and “EXT I/O Port Mode” is set to “Separate.”  
 (Connection Port Settings > EXT I/O (EXT) > Connected Unit)  
 (Connection Port Settings > EXT I/O (EXT) > EXT I/O Port Mode)

① Either of the [EXT1] port or the [MIC] port is usable at the same time. When a microphone is connected to the [MIC] port, the [EXT1] port is disabled.
- 3 Emergency Notification Equipment** ..... Select whether or not to send an emergency notice to the specified bridge-connected destination. (Default: Disable)
- 4 Microphone (MIC)** ..... Select whether or not to send an emergency notice to the microphone connected to the RolP gateway. (Default: Disable)
- 5 RolP Gateway** ..... Select whether or not to send an emergency notice to the bridge-connected other RolP gateways. (Default: Disable)
- 6 <Apply>** ..... Click to apply the settings.
- 7 <Reset>** ..... Click to reset the settings.  
 ① You cannot reset after clicking <Apply>.



## Abnormal Condition Monitoring screen

Expert Settings > Abnormal Condition Monitoring

### LAN Port Link-down

Set the monitor function for a communication error.

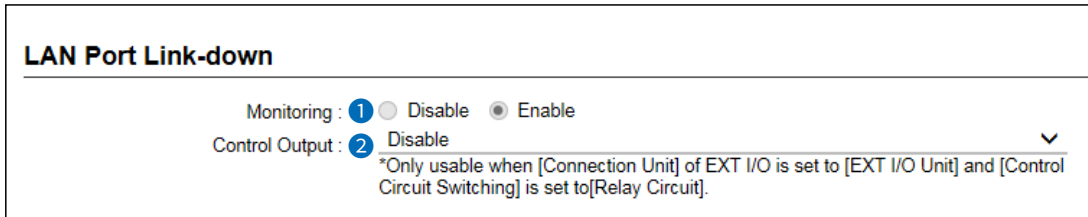

① The screen shows when Monitoring (1) is set to “Enable.”

**1 Monitoring** .....

Select whether or not to detect a RoIP gateway’s LAN port connection error. When an error is detected, it is displayed on the “SYSLOG” screen, as shown below.

(Information > SYSLOG >SYSLOG)

(Default: Disable)

09-11 16:29:32	NOTICE	telephoned: LAN PORT LINK SUCCESS!!
09-11 16:29:12	NOTICE	telephoned: LAN PORT LINK ERROR!!

**2 Control Output** .....

Displayed only when Monitoring (1) is set to “Enable.”

Select whether or not to short the B1/B2 terminal (+/–) to output an error detect signal.

(Default: Disable)

Select a port if you want to enable the output control.

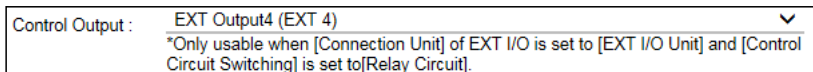

① When enabling the output, confirm Switch Control of the port, that you want to output the error detect signal to, is set to “Relay Circuit.”

(Connection Port Settings > EXT I/O (EXT) > EXT Output Settings > Switching Control)

Abnormal Condition Monitoring screen

Expert Settings > Abnormal Condition Monitoring

## ■ PING Test

Set the monitor function for a communication error.

**PING Test**

---

Monitoring : ①  Disable  Enable \*LAN port Link-down Monitoring is also enabled.

Control Output : ②  ▼

\*Only usable when [Connection Unit] of EXT I/O is set to [EXT I/O Unit] and [Control Circuit Switching] is set to[Relay Circuit].

IP Address : ③

Monitoring Period : ④  minutes

① ② ~ ④ are displayed only when Monitoring (①) is set to “Enable.”

- ① Monitoring** ..... Select whether or not to send PING commands to the host specified by the IP address. When the error is detected, the error is displayed on the “SYSLOG” screen. (Information > SYSLOG >SYSLOG)  
(Default: Disable)
- ② Control Output** ..... Select whether or not to short the B1/B2 terminal (+/–) to output an error detect signal. (Default: Disable)  
 ⓘ Confirm the Relay Circuit is selected.  
 (Connection Port Settings > EXT I/O (EXT) > EXT Output Settings > Switching Control)
- ③ IP Address** ..... Enter the destination IP address to send the PING commands to.
- ④ Monitoring Period** ..... Set the monitor period. (Default: 10)  
 • Range: 1 ~ 4320 (minutes)

Abnormal Condition Monitoring screen

Expert Settings > Abnormal Condition Monitoring

## ■ SIP Server Registration

Set the monitor function for the communication error.

**SIP Server Registration**

---

Monitoring : ①  Disable  Enable

Control Output : ②  Disable  Enable ▼

\*Only usable when [Connection Unit] of EXT I/O is set to [EXT I/O Unit] and [Control Circuit Switching] is set to [Relay Circuit].

③ ④

- ① **Monitoring** .....

Select whether or not to detect the SIP server connection error. When the error is detected, the error is displayed on the “SYSLOG” screen. (Information > SYSLOG >SYSLOG) (Default: Disable)

① The [VoIP] indicator works regardless of this setting.
- ② **Control Output** .....

Displayed only when Monitoring (①) is set to “Enable.”

Select whether or not to short the B1/B2 terminal (+/-) to output an error detect signal. (Default: Disable)

① Confirm the Relay Circuit is selected.  
(Connection Port Settings > EXT I/O (EXT) > EXT Output Settings > Switching Control)
- ③ **<Apply>** .....

Click to apply the settings.
- ④ **<Reset>** .....

Click to reset the settings.

① You cannot reset after clicking <Apply>.

## IP Transceiver Status Filtering screen

Expert Settings > IP Transceiver Status Filtering

### ■ IP Transceiver Status Filtering

Filter settings for transceiver information output to a position information software.

① These settings are for future use.

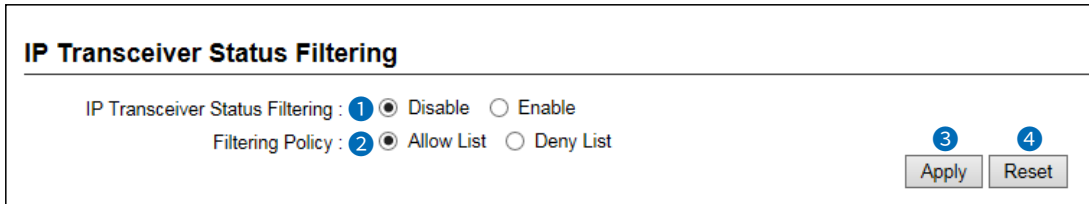

- 1 IP Transceiver Status Filtering**      Select whether or not to use the Filtering function.      (Default: Disable)
- 2 Filtering Policy** .....      Select whether allow or deny outputting the transceiver information listed on the Filtering List.      (Default: Allow List)
  - **Allow List:** Output the listed transceiver information.
  - **Deny List:** Filter the listed transceiver information.
- 3 <Apply>** .....      Click to apply the settings.
- 4 <Reset>** .....      Click to reset the settings.  
① You cannot reset after clicking <Apply>.



IP Transceiver Status Filtering screen

Expert Settings > IP Transceiver Status Filtering

### ■ Filtering List Batch Setting

**Filtering List Batch Setting**

---

Range :  -

\* Enter Unit ID range.

**Range** ..... Enter the range of the unit IDs that you want to add to the Filtering List, and then click <Add> to add transceivers that have an ID within the range. (Example: 00004 ~ 00010)

## Connection Port Extension screen

Expert Settings > Connection Port Extension

### VoIP Settings

Sets the audio quality for RoIP gateway or Bridge. The setting items vary, depending on the TOS Type.

#### TOS Type: Not Used

**VoIP Settings**

Buffering Type: ①  Static  Dynamic

Receive Buffer Size: ② 40 ▼ milliseconds

TOS Type: ③ Not Used ⑤ ⑥ ▼

Apply Reset

#### TOS Type: TOS

**VoIP Settings**

Buffering Type: ①  Static  Dynamic

Receive Buffer Size: ② 40 ▼ milliseconds

TOS Type: ③ TOS ▼

Media (RTP) Priority Level: ④ 7

Media (RTP) Service Type: 0

Media (RTP) (HEX): E0 ⑤ ⑥

Apply Reset

#### TOS Type: Diffserv

**VoIP Settings**

Buffering Type: ①  Static  Dynamic

Receive Buffer Size: ② 40 ▼ milliseconds

TOS Type: ③ Diffserv ▼

Media (RTP) DSCP: ④ 56

Media (RTP) (HEX): E0 ⑤ ⑥

Apply Reset

① The screens above show when the Buffering Type (①) is set to “Static.”

- ① **Buffering Type** ..... Select the jitter buffer used to reduce speech break up due to packet fluctuations. (Default: Dynamic)
  - **Static:** Buffers receive voice data for a set period of time in the Receive Buffer Size (②).
  - **Dynamic:** Buffering time of the received voice data varies, according to the packet fluctuation status.
  
- ② **Receive Buffer Size** ..... Displayed only when Buffering Type (①) is set to “Static.” Set the period of time to buffer the received voice data. (Default: 40)
  - Range: 20 ~ 1000 (milliseconds)
  - ① The shorter the time you set, the less the delay, however the more the sound will be interrupted.

Connection Port Extension screen

Expert Settings > Connection Port Extension

VoIP Settings

TOS Type: Not Used

**VoIP Settings**

Buffering Type: ①  Static  Dynamic

Receive Buffer Size: ② 40 milliseconds

TOS Type: ③ Not Used

⑤ Apply ⑥ Reset

TOS Type: TOS

**VoIP Settings**

Buffering Type: ①  Static  Dynamic

Receive Buffer Size: ② 40 milliseconds

TOS Type: ③ TOS

Media (RTP) Priority Level: ④ 7

Media (RTP) Service Type: 0

Media (RTP) (HEX): E0

⑤ Apply ⑥ Reset

TOS Type: Diffserv

**VoIP Settings**

Buffering Type: ①  Static  Dynamic

Receive Buffer Size: ② 40 milliseconds

TOS Type: ③ Diffserv

Media (RTP) DSCP: ④ 56

Media (RTP) (HEX): E0

⑤ Apply ⑥ Reset

① The screens above show when the Buffering Type (①) is set to "Static."

③ TOS Type .....

Set TOS Type. (Default: Not Used)

- **Not Used:** Does not use the TOS function.
- **TOS:** Outputs the VoIP packet to the TOS field (8 bit) in the IP header, in the TOS (Type Of Service) format.
  - ① TOS format applies RFC1349.
    - The first 3 bits: Shows the priority. Set into "Media (RTP) Priority Level" (④) with a decimal number.
    - The next 4 bits: Shows the service type. Set into "Media (RTP) Service Type" (④) with a decimal number. The larger number, the higher priority.
    - The last 1 bits: Reserved and fixed to "0."
- **DiffServ:** Outputs the VoIP packet to the TOS field (8 bit) in the IP header, in the Diffserv (Differentiated Service) format.
  - ① The Diffserv format details:
    - The former 6 bits: Shows the DSCP. Set "Media (RTP) DSCP" (④) with a decimal number. The larger number, the higher priority.
    - The next 2 bits: Reserved and fixed to "0."



Connection Port Extension screen

Expert Settings > Connection Port Extension

VoIP Settings

TOS Type: Not Used

**VoIP Settings**

Buffering Type: ①  Static  Dynamic

Receive Buffer Size: ② 40 ▼ milliseconds

TOS Type: ③ Not Used ⑤ ⑥ ▼

Apply Reset

TOS Type: TOS

**VoIP Settings**

Buffering Type: ①  Static  Dynamic

Receive Buffer Size: ② 40 ▼ milliseconds

TOS Type: ③ TOS ▼

Media (RTP) Priority Level: ④ 7

Media (RTP) Service Type: 0

Media (RTP) (HEX): E0

⑤ ⑥

Apply Reset

TOS Type: Diffserv

**VoIP Settings**

Buffering Type: ①  Static  Dynamic

Receive Buffer Size: ② 40 ▼ milliseconds

TOS Type: ③ Diffserv ▼

Media (RTP) DSCP: ④ 56

Media (RTP) (HEX): E0

⑤ ⑥

Apply Reset

① The screens above show when the Buffering Type (①) is set to "Static."

- ④ **Media (RTP)** ..... Setting the Priority details for the TOS or Diffserv format options.
  - **Priority Level:** Set the value of the priority level for TOS. (Default: 7)  
Range: 0 ~ 7 (in decimal)
  - **Service Type:** Set the value of the service type for TOS. (Default: 0)  
Range: 0 ~15 (in decimal)
  - **DSCP:** Set the value of DSCP (Differentiated Services Code Point) for Diffserv. (Default: 56)  
Range: 0 ~ 63 (in decimal)
- ⑤ **<Apply>** ..... Click to apply the setting.
- ⑥ **<Reset>** ..... Click to reset the setting.  
① You cannot reset after clicking <Apply>.

## Call Recording screen

Expert Settings > Call Recording

### Common Setting

Set for recording the audio communication between the transceivers.  
The audio is saved in a file in each transmitting or receiving.

**Common Setting**

---

Silence Recording : ①  Disable  Enable

Silence Period to End Recording : ②  seconds

Overwriting the Oldest Files : ③  Disable  Enable

④
⑤

- ① **Silence Recording** ..... Select whether or not to record a communication during there is no communication.  
When enabling this option, the RoIP gateway continues recording for the set period of time in “Silence Period to End Recording,” after the communication has been terminated.  
The second communication that begins while recording will be continuously recorded within the same file. (Default: Enable)
- ② **Silence Period to End Recording** Set the period of time to stop recording when there is no communication. (Default: 5)  
• Range: 1 ~30 seconds
- ③ **Overwriting the Oldest Files** Select whether or not to record and overwrite the older data, when the disk is full. (Default: Disable)
- ④ **<Apply>** ..... Click to apply the settings.
- ⑤ **<Reset>** ..... Click to reset the settings.  
① You cannot reset after clicking <Apply>.

Call Recording screen

Expert Settings > Call Recording

## Recorder Setting

Records communication audio of the linked transceivers.

**Target: Disable**

**Recorder Setting**

Index: ① 1

Mode: ② Recording

Target: ③  Disable  Enable

Call Type: ④ Group

Call ID: 101

① The screens above show when the Call Type (④) is set to "Group."

**Target: Enable**

Target: ③  Disable  Enable

Unit ID: 0101 (Sales1)

- ① **Index** ..... Select an index. You can enter up to 4 recording boxes. (Default: 1)
- ② **Mode** ..... Select the recording/monitor mode. (Default: Disable)
  - **Disable:** Does not record or monitors communication audio.
  - **Recording:** Records the communication audio to an external storage device.
  - **Monitor:** Outputs the specified communication audio to a particular port.
  - **Monitor + Recording:** Simultaneously records and monitors.
- ③ **Target** ..... Select whether or not to set wireless LAN transceivers as recording targets.  
 When enabling this option, select a target wireless LAN transceiver in Unit ID. (Default: Disable)
  - ① When the target transceiver is deleted on the Transceiver Registration screen, the recording settings are disabled. (Transceiver Controller > Transceiver Settings > Transceiver Registration)
- ④ **Call Type** ..... Select the type of call to record or monitor. (Default: All)
  - **Individual:** Individual Calls from or to the specified Call ID.
  - **Group:** Group Calls to the specified Group.
  - **All:** The All Calls.
  - ① When you select "Individual" or "Group," also set the Call ID from the list.

Call Recording screen

Expert Settings > Call Recording

Recorder Setting

**Monitoring**

Destination Address : 5 192.168.0.10

Destination Port Number : 6 25002

Source Port Number : 7 25002

Voice Protocol : 8 G.711u

9 Apply
10 Reset

① Displayed when Mode (2) is set to "Monitor" or "Monitor + Recording."

- 5 Destination Address** ..... Enter the IP address of the destination to be monitored.
- 6 Destination Port Number** ..... Enter the port number of the destination to be monitored.  
 (Default: 1: 25000  
 2: 25002  
 3: 25004  
 4: 25006)
- 7 Source Port Number** ..... Enter the number of the source port that is connected to the destination to be monitored.  
 (Default: 1: 25000  
 2: 25002  
 3: 25004  
 4: 25006)
- 8 Voice Protocol** ..... Displays the voice protocol. (Fixed to "G.711u")
- 9 <Apply>** ..... Click to apply the settings.
- 10 <Reset>** ..... Click to reset the settings.  
 ① You cannot reset after clicking <Apply>.

## Call Recording screen

Expert Settings > Call Recording

### ■ List of Recording Box Entries

Displays the recording box entries.

Index	Mode	Unit ID	Call Type	Call ID	Destination Address	Destination Port Number	Source Port Number	Voice Protocol
1	Recording	0101 (Sales1)	-	-	-	-	-	-
2	Monitor + Recording	0103 (Sales3)	-	-	192.168.0.10	25002	25002	G.711u
3	Disable	-	-	-	-	-	-	-
4	Disable	-	-	-	-	-	-	-

The example in above shows:

- 1: Recording the communication of the Unit ID 0101.
- 2: Transmitting the communication audio of the Unit ID 0103 toward the port 25002 of 192.168.0.10 while recording it.

---

IP Line screen .....	10-2
■ SIP Server .....	10-2
■ List of SIP Server Entries .....	10-3
■ SIP Server Batch Setting .....	10-4
Peer to Peer screen .....	10-5
■ Peer to Peer Common Setting .....	10-5
■ Peer to Peer .....	10-6
■ List of Peer to Peer Entries .....	10-7
VoIP Phonebook screen .....	10-8
■ Save or Write the VoIP Phonebook .....	10-8
■ VoIP Phonebook Entry .....	10-10
■ List of VoIP Phonebook Entries .....	10-11

## IP Line screen

IP Line Settings > IP Line

### ■ SIP Server

Setting used for connecting the RoIP gateway to the Session Initiation Protocol (SIP) server.

The screenshot shows the 'SIP Server' configuration interface. At the top, there is a title 'SIP Server' and a 'Batch Setting Screen' button. Below this, several fields are listed with numbered callouts:
 

- Index: 1 (with a dropdown arrow)
- IP Phone Number: (empty text field)
- SIP Server Address: (empty text field)
- SIP Service Domain: (empty text field)
- User ID: (empty text field)
- Password: (empty text field)
- Registration Expiration: 600 (with 'seconds' label)
- Registration Renewal Timer: Normal: 50%, Exception: 50% (with '%' labels)

 At the bottom right, there are 'Apply' and 'Reset' buttons, each with a numbered callout (9 and 10 respectively).

- 1 Index** ..... Assign the index number for each setting entry.

  - Range: 1 ~ 100
  - ① Click <Batch Setting Screen> if you want to enter 2 or more SIP servers at once. Refer to the SIP Server Batch Setting. (p.10-4)
  
- 2 IP Phone Number** ..... Enter an IP phone number to use as a client of SIP server of up to 31 characters (0~9, #, \*).

  - ① The number must be registered in the SIP server.
  - ① Only when Use Letters for Phone Number is set to "Allow," you can enter capital and small letters as a phone number. (PBX Advanced > Advanced Settings > SIP Settings > Use Letters for Phone Number)
  
- 3 SIP Server Address** ..... Enter a server address or host name of up to 63 characters.
  
- 4 SIP Service Domain** ..... Enter a service domain name of up to 63 characters.
  
- 5 User ID** ..... Enter an authentication user ID of up to 63 characters. Use the IP phone number that is entered in (2).
  
- 6 Password** ..... Enter an authentication password of up to 31 characters.

  - ① The entered password is masked like as "\*\*\*\*\*".
  
- 7 Registration Expiration** ... Set the registration expiration time.

The connection information stored in the SIP server is discarded after the set time has passed. (Default: 600)

  - Range: 60 ~ 28800 seconds.
  
- 8 Registration Renewal Timer** Set the registration renewal interval time to between 10 and 90%. (Default: Normal: 50, Exception: 50)

The interval is expressed by the ratio of the value set in Registration Expiration (7) and the period of the normal and exception condition.
  
- 9 <Apply>** ..... Click to apply the settings.
  
- 10 <Reset>** ..... Click to reset the settings.

  - ① You cannot reset after clicking <Apply>.

## IP Line screen

IP Line Settings > IP Line screen

### List of SIP Server Entries

You can edit the SIP server settings on the list.

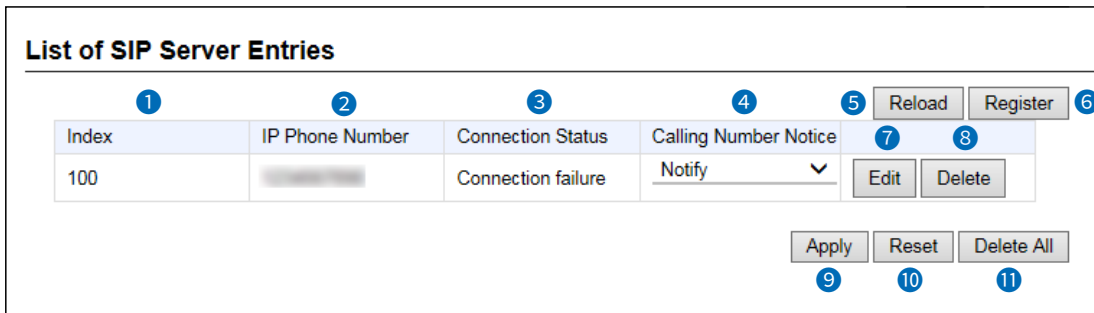

- ① **Index** ..... Displays the index number.
- ② **IP Phone Number** ..... Displays the IP phone number.
- ③ **Connection Status** ..... Displays the SIP server connection status as Connecting, Connection Successful, or Connection failure.
- ④ **Calling Number Notice** ..... Select whether or not to notify your IP phone number to the destination.  
(Default: Notify)  
① Even if this option is set to “Not notified,” the IP phone number may be notified, according to the telephone or line environment.
- ⑤ **<Reload>** ..... Click to reload the screen.  
① When “Connection successful” is not displayed, check the registered settings.
- ⑥ **<Register>** ..... Click to connect to the SIP server.
- ⑦ **<Edit>** ..... Click to edit the entry.
- ⑧ **<Delete>** ..... Click to delete the entry.  
① You cannot restore after clicking <Delete>.
- ⑨ **<Apply>** ..... Click to apply the entry.
- ⑩ **<Reset>** ..... Click to reset the settings.  
① You cannot reset after clicking <Apply>.
- ⑪ **<Delete all>** ..... Click to delete all entries.  
① You cannot restore after clicking <Delete All>.



## IP Line screen

IP Line Settings > IP Line

### ■ SIP Server Batch Setting

You can add 2 or more SIP servers at same time.

This screen is displayed when the “**Batch Setting Screen**” is clicked.

**SIP Server Batch Setting**

Start Number : ① 2 ▼

Add Number : ② 3 ▼

SIP Server Address : ③ \_\_\_\_\_

SIP Service Domain : \_\_\_\_\_

Registration Expiration : 600 \_\_\_\_\_ seconds

Registration Renewal Timer : Normal : 50 % Exception : 50 %

Index	IP Phone Number	User ID	Password	Calling Number Notice
2	_____	_____	_____	Notify ▼
3	_____	_____	_____	Notify ▼
4	_____	_____	_____	Notify ▼

⑤ Apply
⑥ Reset

- ① **Start Number** ..... Enter the start number to add more than 2 Phone Number settings at the same time.
- ② **Add Number** ..... Enter the number of SIP servers you want to add to SIP Service Domains (④).
- ③ **SIP Server Address** ..... Enter the details on SIP server.  
① Refer to the SIP Server Settings for each setting details.
- ④ **SIP Service Domain** ..... Enter the details on SIP service domain.  
① Refer to th SIP Server Settings for each setting details.
- ⑤ **<Apply>** ..... Click to <Apply> the entry.
- ⑥ **<Reset>** ..... Click to reset the settings.  
① You cannot reset after clicking <Apply>.

## Peer to Peer screen

IP Line Settings > Peer to Peer

### Peer to Peer Common Setting

You can edit the Peer to Peer call receive setting from the WAN.

Peer to Peer Common Setting

Calling from the WAN : ① Inhibit ② ③ ▾

Apply Reset

- ① **Calling from the WAN** ..... Select whether or not to permit receiving the Peer to Peer call from the WAN. (Default: Inhibit)
  - ① When you select “Allow,” Your SIP URI has to be registered to the “SIP URI” item on the “VoIP Phonebook” screen at the caller’s SIP server. (IP Line Settings > VoIP Phonebook > VoIP Phonebook Entry > SIP URI)
  - ① The Callee SIP URI must be registered on the VoIP phone book to receive the call through the WAN side.
  
- ② **<Apply>** ..... Click to apply the settings.
  
- ③ **<Reset>** ..... Click to reset the settings.
  - ① You cannot reset after clicking <Apply>.

## Peer to Peer screen

IP Line Settings > Peer to Peer

### Peer to Peer

You can edit SIP URI setting used for Peer to Peer call.

The screenshot shows the 'Peer to Peer' configuration screen. At the top, there is a title bar 'Peer to Peer'. Below it, there is a dropdown menu labeled 'Index' with the value '2' selected. Underneath, there is a text input field labeled 'SIP URI' with a placeholder message: 'The SIP URL needs to have at least one letter, a to z, or A to Z before the @.'. At the bottom right of the form, there are two buttons: 'Apply' and 'Reset'.

- 1 Index** ..... Select the index number for each entry.  
 • Range: 1 ~ 500
  
- 2 SIP URI** ..... Enter the SIP URI up to 63 characters in either format as shown below.  
 • sip: [SIP username]@[VE-PG4 IP address]  
 • sip: [SIP username]@[Host name.domain name]

**About the [SIP username] part:**  
 Enter an alphabet or number in the [SIP username].  
 ① Must include at least one alphabet.

**About the [Host name.domain name] part:**  
 ① When the VE-PG4 IP address is registered in your party's phonebook, enter the IP address (LAN).  
 ① When the VE-PG4 host name is registered in the dynamic DNS or static IP address in your party's Phonebook, enter the specified host name (ex. telephone) or domain name (ex. icom.co.jp).
  
- 3 <Apply>** ..... Click to apply the settings.
  
- 4 <Reset>** ..... Click to reset the settings.  
 ① You cannot reset after clicking <Apply>.

## Peer to Peer screen

IP Line Settings > Peer to Peer

### ■ List of Peer to Peer Entries

Displays the entered or edited Peer to Peer settings.

Index <sup>1</sup>	SIP URI <sup>2</sup>		
1	sip:VEPG4@telephone.icom.co.jp	Edit <sup>3</sup>	Delete <sup>4</sup>
			Delete All <sup>5</sup>

- 1 Index** ..... Displays the index assigned for the entry.
- 2 SIP URI** ..... Displays the SIP URI.
- 3 <Edit>** ..... Click to edit the entry.
- 4 <Delete>** ..... Click to delete the entry.  
① You cannot restore after clicking <Delete>.
- 5 <Delete All>** ..... Click to delete all entries.  
① You cannot restore after clicking <Delete All>.

## VoIP Phonebook screen

IP Line Settings > VoIP Phonebook

### ■ Save or Write the VoIP Phonebook

You can save or write the entered VoIP phonebook.

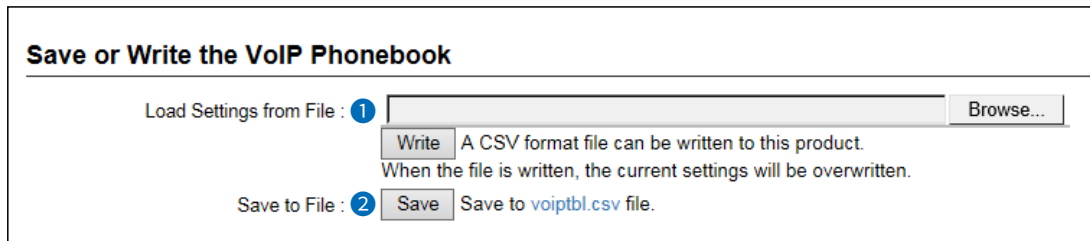

#### 1 Load Settings from File ...

You can load the saved phonebook file in csv format and write it to the RoIP gateway. Click <Browse>, and then select the phonebook file (Example: voiptbl.csv) to load. Verify that the selected file is displayed, and then click <Write>.

- ① The contents of the file is overwritten to "List of VoIP Phonebook Entries."
- ① When the Setting file (Extension: .sav) is used to restore the setting, the VoIP phone book will be overwritten.

#### 2 Save to File .....

Click to save the "List of VoIP Phonebook" as the [List of VoIP Phonebook Entries] file (voiptbl.csv).

- ① You can edit the saved file on a spreadsheet.
- ① You can share the saved file with more than 2 RoIP gateways.

## VoIP Phonebook screen

### IP Line Settings > VoIP Phonebook

#### ■ Save or Write the VoIP Phonebook

##### ○ About the rules of a CSV file for the VoIP phonebook

When editing a saved CSV file, be sure to observe the following rules. Otherwise the VoIP phonebook settings may not load properly into the RoIP gateway.

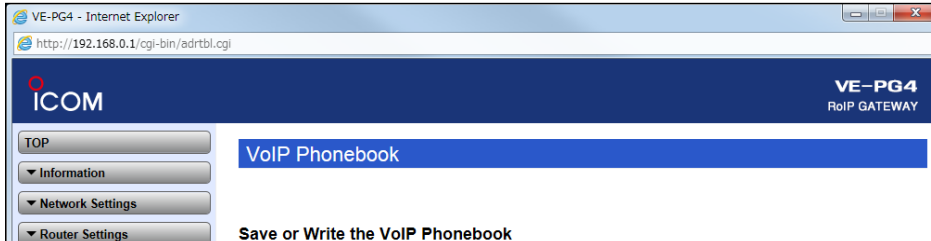

Column	Title	Description
A	Index	1 ~ 1000 Do not duplicate the number.
B	Name	Up to 30 characters
C	Phone Number	"tel:" and up to 31 digits (0~9, #,*)
D	SIP URI	Enter either of the following format, up to 63 characters sip:[SIP user name]@[Destination IP address] sip:[SIP user name]@[Destination host name or domain name]
E	--	Fixed to "voip"

- The lines that begins with "#" are comments.
- Delete unnecessary lines.

## VoIP Phonebook screen

IP Line Settings > VoIP Phonebook

### ■ VoIP Phonebook Entry

Enter the VoIP phone number to use for the Peer to Peer telephone call.

**VoIP Phonebook Entry**

Index : ① 3

Name : ②

Phone Number : ③

SIP URI : ④ sip :

⑤ Apply ⑥ Reset

- ① **Index** ..... Select the index number for each entry.
  - Range: 1 ~1000
  
- ② **Name** ..... Enter the callee name up to 31 characters.
  
- ③ **Phone Number** ..... Enter the phone number.
  - ① When communicating in Peer to Peer, enter the numbers and symbol (#, \*).
  - ① Do not use numbers for the emergency calls in your area, otherwise you cannot make an emergency call.
  
- ④ **SIP URI** ..... Enter the SIP URI up to 63 characters in either format as shown below.
  - sip: [SIP username]@[VE-PG4 IP address]
  - sip: [SIP username]@[Host name.domain name]
  
- ⑤ **<Apply>** ..... Click to apply the settings.
  
- ⑥ **<Reset>** ..... Click to reset the settings.
  - ① You cannot reset after clicking <Apply>.

## VoIP Phonebook screen

IP Line Settings > VoIP Phonebook

### ■ List of VoIP Phonebook Entries

Displays the list of VoIP phone numbers entered in “VoIP phonebook entry.”

List of VoIP Phonebook Entries					
Index	Name	Phone Number	SIP URI	1	2
1	telephone	7000	sip:icom7000@telephone.voip.net	Edit	Delete
2	telephone1	7100	sip:icom7100@telephone.voip.net	Edit	Delete

3 Delete All

1 <Edit> .....

Click to edit the entry.

2 <Delete> .....

Click to delete the entry.

ⓘ You cannot restore after clicking <Delete>.

3 <Delete All> .....

Click to delete all entries.

ⓘ You cannot restore after clicking <Delete All>.



---

Basic screen .....	11-2
■ Basic .....	11-2
Special Number screen .....	11-3
■ Common Special Number .....	11-3
■ Telephone Special Number .....	11-4
■ Transceiver Special Number .....	11-6
■ Transceiver Call Prefix .....	11-7
■ External Call Routing Number .....	11-7
Extension screen .....	11-8
■ Extension .....	11-8
■ List of Extension Entries.....	11-11
■ Extension Batch Setting .....	11-12
■ Extension Detail .....	11-13
Extension Group screen .....	11-15
■ Extension Group Entry .....	11-15
■ List of Extension Group Entries .....	11-18
Inbound Call screen.....	11-19
■ Inbound Call .....	11-19

## Basic screen

PBX > Basic

### Basic

The common setting for the telephones in the network system.

**Basic**

Transfer Return Time : 1 20 seconds

Returned Call Ring Time : 2 30 seconds

Hold Recall Time : 3 120 seconds

Hold Music : 4 Hold Music 1

Hold Music Volume : 5  0 dB  +6 dB

6 Apply 7 Reset

- 1 Transfer Return Time** ..... Set the time period until a transferred call is returned, if the call is not picked up in that period of time. (Default: 20)

  - Range: 0 ~ 99 (seconds)
  - ① When "0" has set, you can not turn back a transferred call.
  
- 2 Returned Call Ring Time** ... Set the ring time when a transferred call has returned. (Default: 30)

  - ① Range: 1 ~ 99 (seconds)
  
- 3 Hold Recall Time** ..... Set the period of time until Notification tone rings, when no one picks up a held call. (Default: 120)

  - Range : 0 ~600 (seconds)
  - ① When "0" has been set, you can not receive the Notification tone.
  
- 4 Hold Music** ..... Set the music on hold. (Default: Hold Music 1)

  - Hold Music 1: For Elise
  - Hold Music 2: Greensleeves
  - Hold Music 3: Home on the range
  - Hold Music 4: Canon
  - Hold Music 5: Minuet
  
- 5 Hold Music Volume** ..... Set the audio volume of the music on hold (Default: 0 dB)

  - Range: 0 dB (calm) or +6 dB (loud)
  
- 6 <Apply>** ..... Click to apply the entries.
  
- 7 <Reset>** ..... Click to reset the settings.

  - ① You cannot reset after clicking <Apply>.

## Special Number screen

PBX > Special Number

### Common Special Number

Sets the common Special Numbers that can be used by both the transceiver and telephones.

Common Special Number											
Call Pickup :	①	*81									
Group Pickup :	②	**									
Direct Pickup :	③	*80									
System Special Number :	④	*82	*93	*85	*88	*89	*99	*84	*86	*76	*97
		*98	*77	*87							

- ① Call Pickup** ..... The number to pick up a call from another extension. (Default: \*81)
- ② Group Pickup** ..... The number to pick up a call from another extension in the same Group. (Default: \*\*)

① You can pick up call from a particular group, by pushing the number set in this setting and the Pickup Group No. (See the Section 13)
- ③ Direct Pickup** ..... The number to pick up a call from a particular extension. (Default: \*80)

① You can pick up call to a particular extension, by pushing the number set in this setting, and then the extension number.
- ④ System Special Number** ... The Special Numbers are those for internal system management. You cannot assign these numbers as extension numbers or as other Special Numbers. (Default: \*82, \*93, \*85, \*88, \*89, \*99, \*84, \*86, \*76, \*97, \*98, \*77, \*87)

Special Number screen

PBX > Special Number

## ■ Telephone Special Number

Sets the special numbers that can be used only by the telephones.

**Options:** Up to 3 digit numbers and characters (0~9, #, \*)

Telephone Special Number	
Call Park :	① *90 _____
Unpark Call :	② *91 _____
Inbound Call Pickup :	③ *92 _____
Speaker Call :	④ *83 _____
Call Forward Always :	⑤ *94 _____
Call Forward No Answer :	⑥ *95 _____
Call Forward Busy :	⑦ *96 _____

**① Call Park** .....

You can park a call by pushing:  
 The number that has been set in this setting, and then the park number or the flexible button (01 ~24) that the Park function is assigned.  
 (Default: \*90)

**② Unpark Call** .....

You can unpark a call by pushing:  
 The number that has been set in this setting, and then the park number or the flexible button (01 ~24) that the Park function is assigned.  
 (Default: \*91)

**③ Inbound Call Pickup** .....

The Special Number, to pick up or unpark an inbound call from an extension in the same Group. (Default: \*92)  
 ⓘ To use this function, set "External Call Status" function to a flexible button (01 ~ 24) in the Button Assignment setting. (See Section 13.)

**To pick up an inbound call from the KX series with another telephone:**

- Dial the number in this setting (for example: \*92), and the Button number (01 ~ 24) of the inbound or parked call.  
 For example, dial "\*\*9203" to pick up the parked call to the Button number 03.

**To pick up an inbound call from another telephone than the KX series:**

- Dialing "\*\*81" is recommended because the incoming phone cannot recognize the External Call Status Button number.

**④ Speaker Call** .....

You can make a speaker call to an extension by pushing:  
 the number that has been set in this setting, and then the extension number. (Default: \*83)  
 ⓘ This function is usable only calls to the KX series telephone.

**⑤ Call Forward Always** .....

The number to forward or cancel forwarding all the incoming call. (Default: \*94)  
 ⓘ To set the forwarding function, dial "\*\*94" and the destination extension number you want to forward a call. (The alarm "PiPi, PiPi" sounds.)  
 ⓘ To cancel forwarding, dial "\*\*94." (The alarm "Pi-Pi-, Pi-Pi-" sounds.)

## Special Number screen

### PBX > Special Number

#### ■ Telephone Special Number

Telephone Special Number	
Call Park :	① *90
Unpark Call :	② *91
Inbound Call Pickup :	③ *92
Speaker Call :	④ *83
Call Forward Always :	⑤ *94
Call Forward No Answer :	⑥ *95
Call Forward Busy :	⑦ *96

#### ⑥ Call Forward No Answer ...

The number to forward when an incoming call does not answer in a certain period of time. (Default: \*95)

- ① To set the forwarding function, dial “\*95” and the destination extension number you want to forward a call. (The alarm “PiPi, PiPi” sounds.)
- ① To cancel forwarding, dial “\*95.” (The alarm “Pi-Pi-, Pi-Pi-” sounds.)

#### ⑦ Call Forward Busy .....

The number to forward when the extension is busy. (Default: \*96)

- ① To set the forwarding function, dial “\*96” and the destination extension number you want to forward a call. (The alarm “PiPi, PiPi” sounds.)
- ① To cancel forwarding, dial “\*96.” (The alarm “Pi-Pi-, Pi-Pi-” sounds.)

Special Number screen

PBX > Special Number

## ■ Transceiver Special Number

Sets the special numbers that can be used only by the transceivers.

**Options:** Up to 3 digit numbers and characters (0~9, #, \*)

Tranceiver Special Number	
OFF-hook for Dialing :	① _____
OFF-hook for Answering :	② # _____
ON-hook :	③ # _____
Immediate Calling :	④ None <span style="float: right;">▼</span>

- ① OFF-hook for Dialing** ..... Set the tone signal starting to dial.  
 Hold down this key for a while, then push the number keys to call.  
(Default: Blank)

① Only when this option is set to a 1 digit number, a transceiver enters off-hook condition by holding this key for the set period of time in OFF-hook Detect Timer, then you will be ready to dial.  
 Also you have to enable the DTMF settings in Connection Port Settings.
- ② OFF-hook for Answering** ... Set the tone signal to receive the telephone call on a transceiver.  
(Default: #)

① Only when this option is set to a 1 digit number, a transceiver can answer a telephone call by holding this key for the set period of time in OFF-hook Detect Timer. Also you have to enable the DTMF settings in Connection Port Settings.

① When no tone signal has set, the call is automatically received.
- ③ ON-hook** ..... Set the tone signal to end (disconnect) the call.  
 Push this key to hook the call on a transceiver. (Default: #)

① Only when this option is set to a 1 digit number, a transceiver can cancel a telephone call by holding this key for the set period of time in OFF-hook Detect Timer. Also you have to enable the DTMF settings in Connection Port Settings.
- ④ Immediate Calling** ..... Set the DTMF code for immediately transmitting the code.  
(Default: None)

Special Number screen

PBX > Special Number

### ■ Transceiver Call Prefix

Sets the prefix to call a transceiver from an extension, by dialing or using the DID (Direct Inward Dialing) function.

**Options:** Up to 4 digit numbers and characters (0~9, #, \*)

- ① To make an individual call, dial the Individual Call prefix, and then dial the Individual number of the transceiver.
- ① To make a Group call, dial the Group Call prefix, and then dial the Group number of the transceiver.
- ① To make an all call, dial the All Call prefix.

**Transceiver Call Prefix**

---

Individual Call :

Group Call :

All Call :

PBX > Special Number

### ■ External Call Routing Number

The routing number to acquire a specific outline telephone number, other than that has set in Extension Settings. (PBX > Extension > Extension Settings)

**External Call Routing Number**

---

Outside Line Phone Number	Line	Routing Number
■	IP Line	<input type="text"/>

**Routing Number** .....

Enter up to 7 digit numbers and character (# or \*) for each phone number.

When dialing a routing number first, you can make an outside line call using the specified outside line telephone number.

- ① Be sure that the routing number does not conflict with other Special Numbers or extension numbers.

## Extension screen

PBX > Extension

### Extension

Sets each extension (IP phone) details.

\* Do not duplicate the Extension Group numbers and extension numbers.

The set status is displayed on the List of Extension Group Entries.

(PBX > Extension Group > List of Extension Group Entries)

#### Port Type : SIP Phone (Automatic Detection)

**Extension**

Port Type : ① SIP Phone (Automatic Detection) ▼

Index : ② 3 ▼

Name : ③ \_\_\_\_\_

Extension Number : ④ \_\_\_\_\_

Password : ⑤ \_\_\_\_\_

Extension Number Notification on Outbound Call : ⑥ Not Notify ▼

IP Line : ⑦ No use ▼

Peer to Peer : ⑧ No use ▼

Connection from WAN : ⑨ Deny ▼

MAC Address : ⑩ \_\_\_\_\_

⑫ Apply    ⑬ Reset

#### Port Type: Converter Bridge

Port Type : ① Converter Bridge ▼

Index : 3 ▼

Name : \_\_\_\_\_

---

IP Line : No use ▼

Peer to Peer : No use ▼

Default Call Destination Number : ⑪ \_\_\_\_\_

⑫ Apply    ⑬ Reset

- ① **Port Type** ..... Set the type of connected device (port.)  
(Default: SIP Phone (Automatic Detection))
- ② **Index** ..... Set the index of the device.  
• Range: 1 ~ 25 for SIP phones, 1 ~ 20 for a converter bridges
- ③ **Name** ..... Set the name of the device up to 31 characters.
- ④ **Extension Number** ..... Set the extension to a 2 to 7 digit number.
- ⑤ **Password** ..... Set the password to connect to the RoIP gateway up to 31 characters.  
① The password is only for a SIP phone.



## Extension screen

### PBX > Extension

#### ■ Extension

#### Port Type : SIP Phone (Automatic Detection)

**Extension**

Port Type : ① SIP Phone (Automatic Detection) ▼

Index : ② 3 ▼

Name : ③ \_\_\_\_\_

Extension Number : ④ \_\_\_\_\_

Password : ⑤ \_\_\_\_\_

Extension Number Notification on Outbound Call : ⑥ Not Notify ▼

IP Line : ⑦ No use ▼

Peer to Peer : ⑧ No use ▼

Connection from WAN : ⑨ Deny ▼

MAC Address : ⑩ \_\_\_\_\_

⑫ Apply    ⑬ Reset

#### Port Type: Converter Bridge

Port Type ① Converter Bridge ▼

Index : 3 ▼

Name : \_\_\_\_\_

---

IP Line : No use ▼

Peer to Peer : No use ▼

Default Call Destination Number ⑪ \_\_\_\_\_

⑫ Apply    ⑬ Reset

#### ⑥ Extension Number Notification on Outbound Call .....

Set whether or not to notify your extension number to a destination on an outbound call. (Default: Not Notify)

- **Not Notify:** Depends on the setting in the Calling Number Notice setting. (IP Line settings > IP Line > List of SIP Server Entries > Calling Number Notice)
- **Notify:** Notifies the Extension Number to the destination.

#### ⑦ IP Line .....

Set an IP phone number for the preset outbound. (Default: No use)

#### ⑧ Peer to Peer.....

Set a SIP user name for an outbound. (Default: No use)

## Extension screen

PBX > Extension

### Extension

#### Port Type : SIP Phone (Automatic Detection)

Extension	
Port Type :	① SIP Phone (Automatic Detection) <input type="button" value="v"/>
Index :	② 3 <input type="button" value="v"/>
Name :	③ <input type="text"/>
Extension Number :	④ <input type="text"/>
Password :	⑤ <input type="text"/>
Extension Number Notification on Outbound Call :	⑥ Not Notify <input type="button" value="v"/>
IP Line :	⑦ No use <input type="button" value="v"/>
Peer to Peer :	⑧ No use <input type="button" value="v"/>
Connection from WAN :	⑨ Deny <input type="button" value="v"/>
MAC Address :	⑩ <input type="text"/>
<input type="button" value="Apply"/> <input type="button" value="Reset"/>	

#### Port Type: Converter Bridge

Extension	
Port Type :	① Converter Bridge <input type="button" value="v"/>
Index :	3 <input type="button" value="v"/>
Peer to Peer :	No use <input type="button" value="v"/>
Default Call Destination Number :	⑪ <input type="text"/>
<input type="button" value="Apply"/> <input type="button" value="Reset"/>	

- ⑨ **Connection from WAN** ...      Displayed only when the Port Type (①) has set to SIP phone. Set whether or not to access to the extension from WAN.  
 ① Be sure to set a long and complicated Password (⑤).
  
- ⑩ **MAC Address** .....      Enter the MAC Address of the Panasonic KX series SIP phone. The MAC Address is settable only when the Port Type (①) is set to other than "SIP Phone (Standard)," "SIP Phone (WLAN)," "Transceiver Controller Telephone Connection," and "Converter Bridge."
  
- ⑪ **Default Call Destination Number** .....      Displayed when the Port Type (①) has set to "Converter Bridge." Enter a destination phone number when the device connected to the Port Type (①) makes a call.
  
- ⑫ **<Apply>** .....      Click to apply the entries.
  
- ⑬ **<Reset>** .....      Click to reset the settings.  
 ① You cannot reset after clicking <Apply>.

## Extension screen

PBX > Extension

### List of Extension Entries

The List of Extension entries.

① The Extension Group List is on the Extension Group screen. (PBX > Extension Group)

<input type="checkbox"/> All	Port Type	Index	Name	Extension Number	Advanced Settings
<input type="checkbox"/>	SIP Phone (Automatic Detection)	1	Sales 01	11	Advanced Edit Delete
<input type="checkbox"/>	SIP Phone (Automatic Detection)	2	Sales 02	12	Advanced Edit Delete
<input type="checkbox"/>	Converter	2			Advanced Edit Delete

Delete Selected Items Delete All

- 1**  All ..... Click to select that you want to delete or copy the setting.  
Click "All" to check or uncheck all the items in the list.
- 2** <Advanced> ..... Click to display the Extension Detail sub window.
- 3** <Edit> ..... Click to edit the settings in the Extension Settings.
- 4** <Delete> ..... Click to delete an entry.
- 5** <Delete Selected Items> ... Click to delete the selected entries.  
① You cannot restore after clicking <Delete Selected Items>.
- 6** <Delete All> ..... Click to delete all the entries.  
① You cannot restore after clicking <Delete All>.

## Extension screen

PBX > Extension

### ■ Extension Batch Setting

You can register extensions by serial numbering, or copy the setting contents to another extension at once.

#### Extension Batch Setting

Port Type: ① SIP Phone ▼

Range: ② \_\_\_\_\_ - \_\_\_\_\_ Add

\* Enter the extension number range.

Copy Settings: ③ Source: SIP Phone 1(31) ▼ Copy

Copy to

All  SIP Phone 1(31)  SIP Phone 2(32)  SIP Phone 3(33)  SIP Phone 4(34)

**Copy Item**

Port Type

Extension Number Notification on Outbound Call

IP Line

Peer to Peer

Connection from WAN

- ① **Port Type** ..... Select the Port Type that you want to copy the settings.  
(Default: SIP Phone)
- ② **Range** ..... Enter the start number and the end number of the extension number range you want to copy to, and then click <Add> to add the entries.
- ③ **Copy Settings** ..... Select the setting options you want to copy and then click <Copy> to copy the settings.

#### Copying the settings

1. Set the source extension details in the "Extension" above on the screen.
2. Enter the range of extension numbers to those you want to copy.
3. Click <Add> to add the extension numbers.
4. In "Source," select a source extension number that you want to copy.
5. In "Copy to," check the extensions to those you want to copy the source settings.
6. In "Copy Item," check the settings to those you want to copy the source settings.
7. Click <Copy> to copy the settings.

Extension screen

PBX > Extension

## ■ Extension Detail

Displayed by clicking <Advanced> in “List of Extension Settings.”  
(PBX > Extension > List of Extension Settings)

**Extension Detail**

Port Type : SIP Phone (Automatic Detection)  
 Index : 1  
 Name : Sales 01  
 Extension Number : 31

**Call Forward Always**  
 Call Forward Settings : ①  Don't Forward  Target  
 Call Forward Number : ② \_\_\_\_\_

**Call Forward No Answer**  
 Call Forward Settings : ③  Don't Forward  Target  
 Call Forward Number : ④ \_\_\_\_\_  
 Call Time : ⑤ 5 seconds

**Call Forward Busy**  
 Call Forward Settings : ⑥  Don't Forward  Target  
 Call Forward Number : ⑦ \_\_\_\_\_

**Extension Group Transfer**  
 Call Forward Settings : ⑧  Don't Forward  Forward

- ① **Call Forward Settings** ..... Select whether or not to forward calls when a call cannot arrive at the destination. (Default: Don't Forward)
- ② **Call Forward Number** ..... Set the destination phone number of up to 31 digits. (Default: Blank)  
 ⓘ The KX series telephone automatically forwards calls to the set destinations.
- ③ **Call Forward Settings** ..... Select whether or not to forward calls when the extension does not answer in the set period of time. (Default: Don't Forward)
- ④ **Call Forward Number** ..... Set the destination phone number of up to 31 digits. (Default: Blank)
- ⑤ **Call Time** ..... Set the delay time to start forwarding. (Default: 5)  
 • Range: 5 ~ 60 (seconds) in 5 second steps

Extension screen

PBX > Extension

■ Extension Detail

**Extension Detail**

Port Type : SIP Phone (Automatic Detection)  
 Index : 1  
 Name : Sales 01  
 Extension Number : 31

**Call Forward Always**  
 Call Forward Settings : ①  Don't Forward  Target  
 Call Forward Number : ② \_\_\_\_\_

**Call Forward No Answer**  
 Call Forward Settings : ③  Don't Forward  Target  
 Call Forward Number : ④ \_\_\_\_\_  
 Call Time : ⑤ 5 ▼ seconds

**Call Forward Busy**  
 Call Forward Settings : ⑥  Don't Forward  Target  
 Call Forward Number : ⑦ \_\_\_\_\_

**Extension Group Transfer**  
 Call Forward Settings : ⑧  Don't Forward  Forward

⑨ Apply
⑩ Reset

- ⑥ **Call Forward Settings** ..... Select whether or not to forward calls from another extension when the extension is busy. (Default: Don't Forward)
- ⑦ **Call Forward Number** ..... Set the destination phone number of up to 31 digits. (Default: Blank)
- ⑧ **Call Forward Settings** ..... Select whether or not to forward inbound calls to the Extension Group. (Default: Don't Forward)
- ⑨ **<Apply>** ..... Click to apply the entries.
- ⑩ **<Reset>** ..... Click to reset the settings.  
 ⓘ You cannot reset after clicking <Apply>.

## Extension Group screen

PBX > Extension Group

You can group up to 50 extension numbers into an Extension Group. You can select the extension (SIP phone) to be incoming and the extension not to receive incoming within the set group.

### ■ Extension Group Entry

Used to newly enter an extension group number.

\* Do not duplicate the Extension numbers and Extension Group numbers.

You can check the extension number and its model name on the “Extension” screen. (PBX > Extension)

**Ringing Sequence: Simultaneous**

**Extension Group Entry**

Port Type : ① SIP Phone ▼

Extension Group Number : ② \_\_\_\_\_

Extension Group Name : ③ \_\_\_\_\_

Ringing Sequence : ④ Simultaneous ▼

1st Ringing : ⑤  All  31  32  33  
 34  41  42  43  
 44  45

2nd Startup Time : ⑥ 10 seconds ▼

2nd Ringing :  All  31  32  33  
 34  41  42  43  
 44  45

3rd Startup Time : Not used ⑦ ⑧ ▼

- ① **Port Type** ..... Select the Port Type that you want to copy the settings.  
(Default: SIP Phone)
- ② **Extension Group Number** Enter a Extension Group number.  
• Range: Number in 2 ~ 7 digits
- ③ **Extension Group Name** ... Enter the Extension Group name of up to 31 characters.
- ④ **Ringing Sequence** ..... Select the action when a call is incoming.  
**Simultaneous:** In Simultaneous ringing sequence, when the primary receiver cannot respond for a certain period of time, you can change to the secondary receiver. You can set the receiver’s extension from the primary to the tertiary for a call.  
**Sequential:** In Sequential ringing, you can set the ringing extension group.

## Extension Group screen

### PBX > Extension Group

#### ■ Extension Group Entry

#### **Ringing Sequence: Simultaneous**

**Extension Group Entry**

Port Type : ① SIP Phone ▼

Extension Group Number : ② \_\_\_\_\_

Extension Group Name : ③ \_\_\_\_\_

Ringing Sequence : ④ Simultaneous ▼

1st Ringing : ⑤  All  31  32  33  
 34  41  42  43  
 44  45

2nd Startup Time : ⑥ 10 seconds ▼

2nd Ringing :  All  31  32  33  
 34  41  42  43  
 44  45

3rd Startup Time : Not used ⑦ ⑧ ▼

#### ⑤ 1st Ringing .....

Check the extension numbers to Ring when a call has arrived at the Extension Group.

- You can also set “2nd Ringing” and “3rd Ringing” by setting the “2nd Startup Time” (⑥) and “3rd Startup Time.”

#### ⑥ 2nd Startup Time .....

Set the period of time until the secondary ring starts when the 1st Ringing extensions do not answer. (Default: Not used)

- Range: Not used, or 10 ~ 60 (seconds) in 5 second steps

#### ⑦ <Apply> .....

Click to apply entries.

#### ⑧ <Reset> .....

Click to reset the settings.

- ① You cannot reset after clicking <Apply>.



Extension Group screen

PBX > Extension Group

■ Extension Group Entry

**Ringing Sequence: Sequential**

**Extension Group Entry**

Port Type: ① SIP Phone

Extension Group Number: ②

Extension Group Name: ③

Ringing Sequence: ④ Sequential

Extension Number: ⑤

001	31	014
002	32	015
003		016
012		
013		

⑥ Apply    ⑦ Reset

- ① **Port Type** ..... Select the Port Type that you want to copy the settings.  
(Default: SIP Phone)
- ② **Extension Group Number** ..... Enter a phone number to an Extension Group.  
Range: number in 2 ~ 7 digits
- ③ **Extension Group Name** ... Enter the Extension Group name of up to 31 characters.
- ④ **Ringing Sequence** ..... Select the action when a call is incoming.  
**Simultaneous:** In simultaneous ringing sequence, when the primary receiver cannot respond for a certain period of time, you can change to the secondary receiver. You can set the receiver's extension from the primary to the tertiary for a call.  
**Sequential:** In Sequential ringing, you can set the ringing extension group.
- ⑤ **Extension Number** ..... Select the action when a call is incoming.
- ⑥ **<Apply>** ..... Click to apply entries.
- ⑦ **<Reset>** ..... Click to reset the settings.  
 ⓘ You cannot reset after clicking <Apply>.

## Extension Group screen

PBX > Extension Group

### List of Extension Group Entries

Displays the list of Extension Group entries.

Port Type	Extension Group Number	Extension Group Name	Ringling Sequence	Extension Number	1	2
SIP Phone	200	Sales	Simultaneous	<1st Ringing> 31 <2nd Ringing> 10 seconds 32 <3rd Ringing> Not used	Edit	Delete
SIP Phone	210	Planning	Sequential	33 34	Edit	Delete
					3 Delete All	

1 <Edit> .....

Click to edit an entry.

2 <Delete> .....

Click to delete an entry.

ⓘ You cannot restore after clicking <Delete>.

3 <Delete All> .....

Click to reset all the entries.

ⓘ You cannot restore after clicking <Delete All>.

## Inbound Call screen

PBX > Inbound Call

### Inbound Call

Sets the destination extension or queuing of Inbound Calls.

Inbound Call				
Phone Number	Line	Connect to ①	Ringtone ②	Queuing ③
	IP Line	Custom 3000*101	Outside Tone A	OFF
	Peer to Peer	None	Inside Tone A	OFF
				④ Apply   ⑤ Reset

- ① **Connect to** ..... Set the destination extension of Inbound calls to the specified phone number (dial-in number.) (Default: None)  
 You can set an extension number or an extension group number.  
 ⓘ If you select "Custom," you can set the Individual ID of a transceiver like an example above.  
 ⓘ To set a Dial-in number, select a DID box in the "DID Settings."  
 (PBX Advanced Settings > DID > DID Settings)
- ② **Ringtone** ..... This setting is only for the KX series SIP phones.  
 Set a Ringtone (pattern) for each phone number.  
 (Default for IP Line: Outside Tone A,  
 for Peer to Peer: Inside Tone A)
- **Outside Tone A ~ C:** Ringtone pattern for an external call.
  - **Inside Tone A ~ C:** Ringtone pattern for an internal call.
  - **Discrimination in the number:** Automatically selects a Ringtone, depending on the phone number of an incoming call.
- ③ **Queuing** ..... If set to ON, the Ringing Tone is returned to a caller until the destination phone number is ready to arrive the call, even when the destination phone number is busy, or another request is incoming to it.  
 (Default: OFF)
- ④ **<Apply>** ..... Click to apply the entries.
- ⑤ **<Reset>** ..... Click to reset the settings.  
 ⓘ You cannot reset after clicking <Apply>.

---

Callee ID to Phone Number screen .....	12-2
■ Save or Write the Callee ID to Phone Number Setting .....	12-2
■ Callee ID to Phone Number .....	12-3
■ List of Callee ID to Phone Number Entries .....	12-4
Outbound Call Restriction screen .....	12-5
■ Outbound Call Restriction .....	12-5
■ Target ID Entry.....	12-6
■ List of Target ID Entries .....	12-6

## Callee ID to Phone Number screen

PBX Transceiver Call Settings > Callee ID to Phone Number

### ■ Save or Write the Callee ID to Phone Number Setting

The common setting for the telephones in the network system.

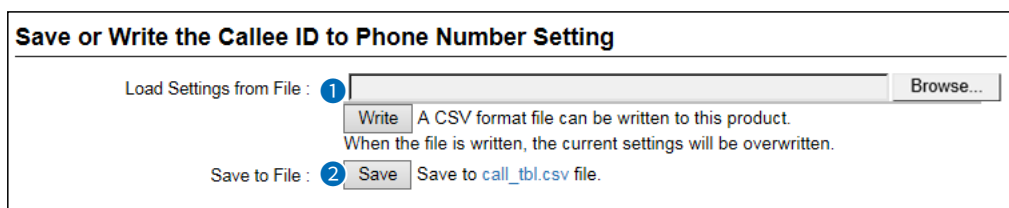

#### 1 Load Settings from File ...

You can load the saved Callee ID to Phone Number settings from a CSV format file. Click <Browse> and select the setting file (call\_tbl.csv) from the displayed list, and then click <Open>. Confirm the correct file is selected, and then click <Write> to load the settings from the selected file.  
① Note that the previous settings are deleted when the setting file is loaded.

#### 2 Save to File .....

Saves the settings in the “List of Callee ID to Phone Number Entries” to a CSV format file. Click <Save> and select a folder to save the file into. You can edit the saved file in a spreadsheet.

## Callee ID to Phone Number screen

PBX Transceiver Call Settings > Callee ID to Phone Number

### ■ Callee ID to Phone Number

Enter phone numbers that the RoIP gateway dials to call up SIP phones, when making calls from linked transceivers.

Callee ID to Phone Number						
Index ①	Name ②	Callee ID ④			Phone Number ⑥	
		Call Type ③	Prefix ID	Destination ID ⑤		⑦
1 ▾		Individual ▾				Add

- ① **Index** ..... The index assigned for entry.
  - Range: 1 ~ 1000
  
- ② **Name** ..... Enter a name of up to 31 characters.
  
- ③ **Call Type** ..... Select the type of call.  
 Call the destinations that matches both of Prefix ID (④) and Destination ID (⑤) settings.
  - Individual: Call only a specified radio.
  - Group: Call all radios that belong to a specified group.
  - All: Call all radios.
  
- ④ **Prefix ID** ..... Enter the prefix ID of the destination.
  - ID range: (Depends on the system mode)
  
- ⑤ **Destination ID** ..... Enter the ID of the destination.
  - ID range: (Depends on the system mode)
  
- ⑥ **Phone Number** ..... Enter the phone number of up to 31 digits.
  
- ⑦ **<Add>** ..... Click to add the entry.
  - ① The registered contents are displayed on the List of Callee ID to Phone Number Entries screen.

## Callee ID to Phone Number screen

PBX Transceiver Call Settings > Callee ID to Phone Number

### ■ List of Callee ID to Phone Number Entries

List of the Callee ID entries.

Index	Name	Callee ID			Phone Number	Edit	Delete
		Call Type	Prefix ID	Destination ID			
1	Sales 01	Individual	1	31	31	1	2

3  
Delete All

- 1 <Edit> ..... Click to edit an entry.
- 2 <Delete> ..... Click to delete an entry.  
ⓘ You cannot restore after clicking <Delete>.
- 3 <Delete All> ..... Click to delete all the entries.  
ⓘ You cannot restore after clicking <Delete All>.

## Outbound Call Restriction screen

PBX Transceiver Call Settings > Outbound Call Restriction

### ■ Outbound Call Restriction

Set the restriction rules for making outbound calls by the client transceivers.

Outbound Call Restriction

Restriction Type : 1 Deny  Allow

2 Apply 3 Reset

- 1 **Restriction Type** ..... Select the type of restriction on the transceivers in the “List of Target ID Entries.” (See the next page.) (Default: Deny)  
Deny: Inhibits the listed transceivers to make phone calls.  
Allow: Allows the listed transceivers to make phone calls.
- 2 **<Apply>** ..... Click to apply the entries.
- 3 **<Reset>** ..... Click to reset the entries.  
ⓘ You cannot restore after clicking <Apply>.



## Outbound Call Restriction screen

PBX Transceiver Call Settings > Outbound Call Restriction

### ■ Target ID Entry

Enter the transceivers for the Outbound Call Restriction.

- 1 Index** ..... The index assigned for entry. (Default: 1)  
 • Range: 1 ~ 1000
- 2 Prefix ID** ..... Enter the prefix ID of the client transceiver.  
 • ID range: (Depends on the system mode)
- 3 Transceiver ID**..... Enter the ID of the client transceiver.  
 • ID range: (Depends on the system mode)
- 4 <Add>** ..... Click to add the entry.  
 ① The registered contents are displayed on the [List of Target ID Entries] screen.
- 5 <Reset>** ..... Click to reset the entries.  
 ① You cannot restore after clicking <Reset>.

PBX Transceiver Call Settings > Outbound Call Restriction

### ■ List of Target ID Entries

List of transceivers for the Outbound Call Restriction.

Index	Prefix ID	Transceiver ID		
1	1	0001	Edit	Delete
2	1	0002	Edit	Delete

Delete All

- 1 <Edit>** ..... Click to edit the entry.  
 ① The registered contents are displayed on the [Target ID Entry] screen.
- 2 <Delete>** ..... Click to delete an entry.  
 ① You cannot restore after clicking <Delete>.
- 3 <Delete All>** ..... Click to delete all the entries.  
 ① You cannot restore after clicking <Delete All>.

Telephone (KX-UT Series) screen .....	13-3
■ Telephone Maintenance .....	13-3
■ Telephone Group .....	13-5
■ Telephone Individual Settings (KX-UT Series) <b>Common Setting</b> .....	13-5
■ Dial Tone <b>Common Setting</b> .....	13-6
■ Busy Tone <b>Common Setting</b> .....	13-7
■ Reorder Tone <b>Common Setting</b> .....	13-8
■ Ring Back Tone <b>Common Setting</b> .....	13-9
■ Hold Alarm <b>Common Setting</b> .....	13-10
■ Ringtone Pattern <b>Common Setting</b> .....	13-11
■ Ringtone Pattern Assignment <b>Common Setting</b> .....	13-12
■ Telephone Common Settings <b>Group 1 ~ 30</b> .....	13-13
■ Telephone Individual Settings (KX-UT Series) <b>Group 1 ~ 30</b> .....	13-14
■ Button Assignment .....	13-16
Telephone (KX-HDV Series) screen .....	13-20
■ Telephone Maintenance .....	13-20
■ Telephone Group .....	13-22
■ Dial Tone <b>Common Setting</b> .....	13-23
■ Busy Tone <b>Common Setting</b> .....	13-24
■ Reorder Tone <b>Common Setting</b> .....	13-25
■ Ring Back Tone <b>Common Setting</b> .....	13-26
■ Hold Alarm <b>Common Setting</b> .....	13-27
■ Ringtone Pattern <b>Common Setting</b> .....	13-28
■ Ringtone Pattern Assignment <b>Common Setting</b> .....	13-29
■ Telephone Common Settings <b>Group 1 ~ 30</b> .....	13-30
■ Telephone Individual Settings (KX-HDV Series) <b>Group 1 ~ 30</b> .....	13-31
Expand Unit (KX-HDV230) Expand Unit 1 ~ 5 screen .....	13-38
■ Telephone Maintenance .....	13-38
■ Telephone Group .....	13-40
■ Telephone Individual Settings (KX-HDV230) .....	13-41
Phonebook screen .....	13-42
■ Select Group Setting .....	13-42
■ Save or Write the Phonebook .....	13-43
■ Phonebook Entry .....	13-45
■ List of Phonebook Entries .....	13-47

Transceiver Controller Telephone Connection screen .....	13-48
■ Transceiver Controller Telephone Connection .....	13-48
■ Communication .....	13-49
■ Control .....	13-50
■ PTT Control Setting .....	13-56
■ Call Initiation Setting .....	13-57
■ Notice Tone on the Telephone .....	13-58
■ Release Timer .....	13-59
Converter Bridge screen .....	13-60
■ Converter Bridge .....	13-60
■ Connection .....	13-61
■ Communication .....	13-64
■ Control .....	13-65
■ DTMF Dialing .....	13-69
■ PTT Control Setting .....	13-70
■ Call Initiation Setting .....	13-71
■ Notice Tone on the Telephone .....	13-72
■ Release Timer .....	13-73

## Telephone (KX-UT Series) screen

PBX Extension > Telephone (KX-UT Series)

### ■ Telephone Maintenance

Assigns a Group to each extension number.

The settings for each extension detail can be edited in "List of Extension Entries" (PBX > Extension > List of Extension Entries).

Telephone Maintenance					
<input type="checkbox"/> All ①	Extension Number ②	Port Type ③	Status ④	Group ⑤	⑥
<input type="checkbox"/>	31	SIP Phone (Automatic Detection)	Connected	Group 1 ▼	Reboot
<input type="checkbox"/>	32	SIP Phone (Automatic Detection)	Connected	Group 1 ▼	Reboot
<input type="checkbox"/>	33	SIP Phone (Automatic Detection)	Not Connected	Group 1 ▼	Reboot
<input type="checkbox"/>	34	SIP Phone (Automatic Detection)	Not Connected	Group 1 ▼	Reboot
	3000	Transceiver Controller Telephone Connection	--	Group 1 ▼	

⑦ Reboot Selected    ⑧ Reboot All  
⑨ Apply    ⑩ Reset

- ① **Check Box** ..... Click to select the extensions if you want to reboot one or more KX series telephones. Click "All" to select all the entries.  
 ① The extensions where Status (④) is "Not Connected" cannot be selected.
  
- ② **Extension Number**..... Displays the extension number.
  
- ③ **Port Type** ..... Displays the port type of the Extension.
  
- ④ **Status** ..... Displays the connection status of the telephone.  
 ① "Not Connected" is displayed for the telephone that is not registered to the SIP server of this RoIP gateway.  
 ① "--" is displayed for the Converter bridge or the Transceiver Controller Telephone Connection.
  
- ⑤ **Group** ..... Set the setting Group of the extension. (Default: Group 1)  
 • Options: Group 1 ~ 30  
 ① You can customize the flexible function button assignments for each Group.

## Telephone (KX-UT Series) screen

### PBX Extension > Telephone (KX-UT Series)

#### ■ Telephone Maintenance

**Telephone Maintenance**

<input type="checkbox"/> All <sup>1</sup>	Extension Number <sup>2</sup>	Port Type <sup>3</sup>	Status <sup>4</sup>	Group <sup>5</sup>	<sup>6</sup>
<input type="checkbox"/>	31	SIP Phone (Automatic Detection)	Connected	Group 1 ▼	Reboot
<input type="checkbox"/>	32	SIP Phone (Automatic Detection)	Connected	Group 1 ▼	Reboot
<input type="checkbox"/>	33	SIP Phone (Automatic Detection)	Not Connected	Group 1 ▼	Reboot
<input type="checkbox"/>	34	SIP Phone (Automatic Detection)	Not Connected	Group 1 ▼	Reboot
	3000	Transceiver Controller Telephone Connection	--	Group 1 ▼	

<sup>7</sup> Reboot Selected
<sup>8</sup> Reboot All  
<sup>9</sup> Apply
<sup>10</sup> Reset

- <sup>6</sup> **<Reboot>** ..... Click to reboot the KX series telephone.
- <sup>7</sup> **<Reboot Selected>** ..... Click to reboot the selected (with check marks) KX series telephones.
- <sup>8</sup> **<Reboot All>** ..... Click to reboot all the KX series telephones whose Status (<sup>4</sup>) is "Connected" in the list.
- <sup>9</sup> **<Apply>** ..... Click to apply the entries.
- <sup>10</sup> **<Reset>** ..... Click to reset the settings.  
 ⓘ You cannot reset after clicking <Apply>.

## Telephone (KX-UT Series) screen

PBX Extension > Telephone (KX-UT Series)

### ■ Telephone Group

Edits the Group setting of the entered extension (telephone)

**Telephone Group**

---

Select Group Setting : Common Setting ▼ Edit

**Select Group Setting** ..... Select the setting mode.

- **Common Setting**

Common settings for the KX-UT Series that are connected to the RoIP gateway, such as the tone patterns or volume levels.

- **Group 1 ~ Group 30**

The custom settings for the KX-UT Series in the selected Group that are connected to the RoIP gateway, such as the flexible button assignments.

PBX Extension > Telephone (KX-UT Series)

### ■ Telephone Individual Settings (KX-UT Series) Common Setting

The Group setting of the entered extension (telephone)

**Telephone Individual Settings (KX-UT Series)**

---

RX Volume: 1 0 ▼ dB

TX Volume: 2 0 ▼ dB

Echo Canceller: 3  Disable  Enable

**1 RX Volume** ..... Set the telephone's receiving audio level. (Default: 0)  
 • Range: -6 (minimum) ~ +6 (maximum) (dB)

**2 TX Volume** ..... Set the telephone's transmitting audio level. (Default: 0)  
 • Range: -6 (minimum) ~ +6 (maximum) (dB)

**3 Echo Canceller** ..... Enabling this option prevents an echo when transmitting and receiving. (Default: Disable)

## Telephone (KX-UT Series) screen

PBX Extension > Telephone (KX-UT Series)

### ■ Dial Tone Common Setting

Sets the tone when off-hook.

**Dial Tone**

Frequency 1: 350 Hz

Frequency 2: 440 Hz

Level: 0 dB

Repeat:  Disable  Enable  Continuous Sound

Timing: 60 0

- 1 Frequency 1/2** ..... Set the tone frequencies of the Dial tone.  
(Default: Frequency 1: 350 / Frequency 2: 440)

  - Range: 0 (inaudible), 200 ~ 2000 (Hz)
  - ① The 350 Hz and 440 Hz tones simultaneously sound at default.
  
- 2 Level** ..... Set the audio level of the Dial tone. (Default: 0)

  - Range: -24 (minimum) ~ +6 (maximum) (dB)
  
- 3 Repeat** ..... Set whether or not to repeat the set tone pattern.  
(Default: Continuous Sound)

  - **Disable:** Sounds the set pattern in Timing (4) only once
  - **Enable:** Continuously repeats the set pattern in Timing (4)
  - **Continuous Sound:** Continuously sounds frequencies 1 and 2 (1)
  
- 4 Timing** ..... Set the pattern of tone rings and mutes using up to 9 values. The tone sounds for the set period of time in the ON settings, and mutes for the set period of time in the OFF settings.  
(Default: 60, 0)

  - Range of the first "OFF": 60 ~ 16000 (milliseconds)
  - Range of the others: 51 ~ 16000 (milliseconds)

## Telephone (KX-UT Series) screen

PBX Extension > Telephone (KX-UT Series)

### ■ Busy Tone Common Setting

Sets the tone when the line is busy.

**Busy Tone**

Frequency 1: 1 480 Hz

Frequency 2: 620 Hz

Level: 2 0 dB

Repeat: 3  Disable  Enable  Continuous Sound

Timing: 4

OFF	ON	OFF	ON	OFF	ON	OFF	ON	OFF
60	500	440						

- 1 Frequency 1/2** ..... Set the tone frequencies of the Busy tone.  
 (Default: Frequency 1: 480 / Frequency 2: 620)

  - Range: 0 (inaudible), 200 ~ 2000 (Hz)
  - ① The 480 Hz and 620 Hz tones simultaneously sound at default.
  
- 2 Level** ..... Set the audio level of the Busy tone. (Default: 0)

  - Range: -24 (minimum) ~ +6 (maximum) (dB)
  
- 3 Repeat** ..... Set whether or not to repeat the set tone pattern. (Default: Enable)

  - **Disable:** Sounds the set pattern in Timing (4) only once
  - **Enable:** Continuously repeats the set pattern in Timing (4)
  - **Continuous Sound:** Continuously sounds frequencies 1 and 2 (1)
  
- 4 Timing** ..... Set the pattern of tone rings and mutes using up to 9 values. The tone sounds for the set period of time in the ON settings, and mutes for the set period of time in the OFF settings. (Default: 60, 500, 440)

  - Range of the first "OFF": 60 ~ 16000 (milliseconds)
  - Range of the others: 51 ~ 16000 (milliseconds)



## Telephone (KX-UT Series) screen

PBX Extension > Telephone (KX-UT Series)

### ■ Reorder Tone Common Setting

Sets the Reorder tone.

**Reorder Tone**

Frequency 1 : 480 Hz

Frequency 2 : 620 Hz

Level : 0 dB

Repeat : 3  Disable  Enable  Continuous Sound

Timing : 4

OFF	ON	OFF	ON	OFF	ON	OFF	ON	OFF
.60	250	.190						

- 1 Frequency 1/2** ..... Set the tone frequencies of the Reorder tone. (Default: Frequency 1: 480 / Frequency 2: 620)

  - Range: 0 (inaudible), 200 ~ 2000 (Hz)
  - ① The 480 Hz and 620 Hz tones simultaneously sound at default.
- 2 Level** ..... Set the audio level of the Reorder tone. (Default: 0)

  - Range: -24 (minimum) ~ +6 (maximum) (dB)
- 3 Repeat** ..... Set whether or not to repeat the set tone pattern. (Default: Enable)

  - **Disable:** Sounds the set pattern in Timing **4** only once
  - **Enable:** Continuously repeats the set pattern in Timing **4**
  - **Continuous Sound:** Continuously sounds frequencies 1 and 2 **1**
- 4 Timing** ..... Set the pattern of tone rings and mutes using up to 9 values. The tone sounds for the set period of time in the ON settings, and mutes for the set period of time in the OFF settings. (Default: 60, 250, 190)

  - Range of the first "OFF": 60 ~ 16000 (milliseconds)
  - Range of the others: 51 ~ 16000 (milliseconds)

## Telephone (KX-UT Series) screen

PBX Extension > Telephone (KX-UT Series)

### Ring Back Tone Common Setting

Sets the Ringback tone.

**Ring Back Tone**

---

Frequency 1 : 440 Hz

Frequency 2 : 480 Hz

Level : 0 dB

Repeat :  Disable  Enable  Continuous Sound

Timing : 60 2000 3940

- 1 Frequency 1/2** ..... Set the tone frequencies of the Ringback tone.  
 (Default: Frequency 1: 440 / Frequency 2: 480)

  - Range: 0 (inaudible), 200 ~ 2000 (Hz)
  - ① The 440 Hz and 480 Hz tones simultaneously sound at default.
  
- 2 Level** ..... Set the audio level of the Ringback tone. (Default: 0)

  - Range: -24 (minimum) ~ +6 (maximum) (dB)
  
- 3 Repeat** ..... Set whether or not to repeat the set tone pattern. (Default: Enable)

  - **Disable:** Sounds the set pattern in Timing (4) only once
  - **Enable:** Continuously repeats the set pattern in Timing (4)
  - **Continuous Sound:** Continuously sounds frequencies 1 and 2 (1)
  
- 4 Timing** ..... Set the pattern of tone rings and mutes using up to 9 values. The tone sounds for the set period of time in the ON settings, and mutes for the set period of time in the OFF settings. (Default: 60, 2000, 3940)

  - Range of the first "OFF": 60 ~ 16000 (milliseconds)
  - Range of the others: 51 ~ 16000 (milliseconds)

## Telephone (KX-UT Series) screen

PBX Extension > Telephone (KX-UT Series)

### ■ Hold Alarm Common Setting

Sets the Hold alarm tone that sounds to alert you a second call has been held for certain period of time.

**Hold Alarm**

Frequency 1: 1 425 Hz

Frequency 2: 2 0 Hz

Level: 3 0 dB

Repeat: 4  Disable  Enable  Continuous Sound

Timing: <span style="border: 1px solid black; border-radius: 50%; padding: 2px;">4</span>	ON	OFF	ON	OFF	ON	OFF	ON	OFF
	120	14880						

- 1 Frequency 1/2** ..... Set the tone frequencies of the Hold alarm.  
 (Default: Frequency 1: 425 / Frequency 2: 0)  
 • Range: 0 (inaudible), 200 ~ 2000 (Hz)
- 2 Level** ..... Set the audio level of the Hold alarm. (Default: 0)  
 • Range: -24 (minimum) ~ +6 (maximum) (dB)
- 3 Repeat** ..... Set whether or not to repeat the set tone pattern. (Default: Enable)  
 • **Disable:** Sounds the set pattern in Timing **(4)** only once  
 • **Enable:** Continuously repeats the set pattern in Timing **(4)**  
 • **Continuous Sound:** Continuously sounds frequencies 1 and 2 **(1)**
- 4 Timing** ..... Set the pattern of tone rings and mutes using up to 9 values. The tone sounds for the set period of time in the ON settings, and mutes for the set period of time in the OFF settings. (Default: 120, 14880)  
 • Range of the first "OFF": 60 ~ 16000 (milliseconds)  
 • Range of the others: 51 ~ 16000 (milliseconds)

## Telephone (KX-UT Series) screen

PBX Extension > Telephone (KX-UT Series)

### ■ Ringtone Pattern Common Setting

Sets the Ringtone patterns.

**Ringtone Pattern**

\*Unit of Ringtone set values shown are in milliseconds.

Pattern 1 : 

ON	OFF	ON	OFF	ON	OFF	ON	OFF
2000	4000						

Pattern 2 : 

ON	OFF	ON	OFF	ON	OFF	ON	OFF
800	400	800	4000				

Pattern 3 : 

ON	OFF	ON	OFF	ON	OFF	ON	OFF
400	200	400	200	800	4000		

Pattern 4 : 

ON	OFF	ON	OFF	ON	OFF	ON	OFF
300	200	1000	200	300	4000		

Pattern 5 : 

ON	OFF	ON	OFF	ON	OFF	ON	OFF
2000	4000						

**Pattern 1 ~ 5.....**

Set the pattern of tone rings and mutes using up to 8 values. The tone sounds for the set period of time in the ON settings, and mutes for the set period of time in the OFF settings.

#### ○ The default values of Ringtone Patterns

Pattern	ON	OFF	ON	OFF	ON	OFF	ON	OFF
Pattern 1	2000	4000	-	-	-	-	-	-
Pattern 2	800	400	800	4000	-	-	-	-
Pattern 3	400	200	400	200	800	4000	-	-
Pattern 4	300	200	1000	200	300	4000	-	-
Pattern 5	2000	4000	-	-	-	-	-	-

- Range : 51 ~ 5000 (milliseconds)
- ① A ring pattern must end with OFF.
- ① The ring patterns can be assigned, according to the incoming call type.  
See the next item for details.

## Telephone (KX-UT Series) screen

PBX Extension > Telephone (KX-UT Series)

### ■ Ringtone Pattern Assignment Common Setting

Assigns the Ringtone pattern of each incoming call group.

Ringtone Pattern Assignment		
Outside Line A :	Pattern 1	▼
Outside Line B :	Pattern 2	▼
Outside Line C :	Pattern 3	▼
Extension A :	Pattern 5	▼
Extension B :	Pattern 4	▼
Extension C :	Pattern 3	▼
Extension Assignment :	Pattern 2	▼
Hold Recall :	Pattern 2	▼
		<input type="button" value="Apply"/> <input type="button" value="Reset"/>

Assign a Ringtone pattern for each incoming call type, according to the setting on the Inbound Call screen. (PBX > Inbound Call)

#### ① Information

- The incoming call group depends on the notified number of incoming calls.
- The calls from the phone numbers that are entered into extensions A to C are treated as the internal calls.
- For an internal call from other than the entered extensions on the Inbound Call screen, the Ringtone pattern set in the “Extension Assignment” sounds.
- When recalling to a parked telephone, the Ringtone set in the “Hold Recall” sounds.

## Telephone (KX-UT Series) screen

PBX Extension > Telephone (KX-UT Series)

### ■ Telephone Common Settings Group 1 ~ 30

Sets the rules for incoming calls for each Extension Group.

Telephone Common Settings	
Pickup Group Number :	<span style="border: 1px solid black; border-radius: 50%; padding: 2px;">1</span> 01
Call Pickup Target :	<span style="border: 1px solid black; border-radius: 50%; padding: 2px;">2</span> Extension Only <span style="float: right;">▼</span>
Group Pickup Target :	<span style="border: 1px solid black; border-radius: 50%; padding: 2px;">3</span> External Call/Extension <span style="float: right;">▼</span>
Directed Call Pickup Target :	<span style="border: 1px solid black; border-radius: 50%; padding: 2px;">4</span> External Call/Extension <span style="float: right;">▼</span>
Call Restriction :	<span style="border: 1px solid black; border-radius: 50%; padding: 2px;">5</span> Disable <span style="float: right;">▼</span>

- 1 Pickup Group Number .....** Enter a pick up group number of up to 7 digits.  
(Default: 01 (for the Group1))

① You can pick up an incoming call of another group extension by dialing the Special Number for the Group Pickup and the Group Number of the group. (For example: Dial “\*\*01” to pick up the call to Group 1.)
- 2 Call Pickup Target .....** Set the incoming call type that the group can pick up.  
(Default: Extension Only)

  - Options: External Call/Extension, External Call Only, or Extension Only
- 3 Group Pickup Target.....** Set the incoming call type that you can pick up, that arrives at an extension in the same Group. (Default: External Call/Extension)

  - Options: External Call/Extension, External Call Only, or Extension Only
- 4 Directed Call Pickup Target** Set the type of directed call that you can pick up  
(Default: External Call/Extension)

  - Options: External Call/Extension, External Call Only, or Extension Only
- 5 Call Restriction .....** Select whether or not to restrict making an external call.  
(Default: Disable)

  - **Disable:** You can make external calls.
  - **Call Restriction Rule 1 ~ 16:** Restricts external calls according to the rules. The rules can be set in “Outbound Call Restriction Rule Settings.”  
(PBX Advanced Settings > Numbering Plan > Outbound Call Restriction Rule Settings)
  - **External Call Restriction:** You cannot make any external calls but you can make internal calls (including Peer to Peer calls.)

## Telephone (KX-UT Series) screen

PBX Extension > Telephone (KX-UT Series)

### ■ Telephone Individual Settings (KX-UT Series) Group 1 ~ 30

Sets the rules for the incoming calls, and so on, to each Extension group.

**Telephone Individual Settings (KX-UT Series)**

Dial Waiting Time : ① 5 ▼ seconds

Accept Internal Calls while on an External Call : ②  Refuse  Allow

Accept External Calls without Button Assignment : ③  Refuse  Allow

Holding a Call with the External Call Status Button : ④  Refuse  Allow

Long-Hold Watch Time : ⑤ 180 seconds

Phonebook Sharing : ⑥  Disable  Enable

Common Phonebook Sharing : ⑦  Disable  Enable

Ringtone Setting (Phonebook) : ⑧ Ringtone 1 ▼

Key Click Tone : ⑨  Disable  Enable

- ① **Dial Waiting Time** ..... The waiting time to start dialing after you finished dialing. (Default: 5)
- Range: 1 ~ 15 (seconds)
- ② **Accept Internal Calls while on an External Call** ..... Set whether or not to accept an incoming extension call (including a Peer to Peer call) while you are talking on an external call. (Default: Refuse)
- ① When setting to “Refuse,” the busy tone will be returned to an incoming extension call.
- ③ **Accept External Calls without Button Assignment** Set whether or not to accept an inbound call to a <DN key> button when an <External Call Status> button is not assigned or all <External Call Status> buttons are busy. (Default: Allow)
- **Allow:** Accepts an inbound call to a <DN key> button.
  - **Refuse:** Rejects an inbound call and returns the busy tone.
- ④ **Holding a Call with the External Call Status Button** When selecting “Allow,” you can hold an external call using an <External Call Status> button. (Default: Refuse)
- ⑤ **Long-Hold Watch Time**..... Sounds an alert if you hold a call for time longer than the set period of time. (Default: 180)
- Range: 30 ~ 240 (seconds)

## Telephone (KX-UT Series) screen

### PBX Extension > Telephone (KX-UT Series)

#### ■ Telephone Individual Settings (KX-UT Series)

**Telephone Individual Settings (KX-UT Series)**

Dial Waiting Time : ① 5 ▼ seconds

Accept Internal Calls while on an External Call : ②  Refuse  Allow

Accept External Calls without Button Assignment : ③  Refuse  Allow

Holding a Call with the External Call Status Button : ④  Refuse  Allow

Long-Hold Watch Time : ⑤ .180 seconds

Phonebook Sharing : ⑥  Disable  Enable

Common Phonebook Sharing : ⑦  Disable  Enable

Ringtone Setting (Phonebook) : ⑧ Ringtone 1 ▼

Key Click Tone : ⑨  Disable  Enable

- ⑥ Phonebook Sharing** ..... Set whether or not to download the Phonebook data from the RoIP gateway at every boot up of a KX series telephone. You can download up to 300 entries to the common phonebook and up to 100 entries to the Group phonebook. (Default: Enable)
- ⑦ Common Phonebook Sharing** Displayed only when “Phonebook Sharing” (⑥) is enabled. Set whether or not to download the Common Phonebook data from the RoIP gateway at every boot up of KX series telephones. (Default: Enable)
- ⑧ Ringtone Setting (Phonebook)** Select a ringtone from the Ringtone 1 ~ 32. (Default: Ringtone 1)
- ⑨ Key Click Tone** ..... Set whether or not to sound a tone when you push a key of a KX series telephone. (Default: Enable)



## Telephone (KX-UT Series) screen

PBX Extension > Telephone (KX-UT Series)

### ■ Button Assignment

Sets the functions of the flexible buttons on the telephone.

Button Assignment													
<ul style="list-style-type: none"> <li>One Touch</li> <li>DN Key</li> <li>External Call Status</li> <li>Call Fwd Always</li> <li>Call Fwd No Answer</li> <li>Call Fwd Busy</li> <li>Headset</li> <li>Not used</li> </ul>	<table border="1"> <tr> <td>Button 24</td> <td>DN Key</td> </tr> <tr> <td>Button 23</td> <td>DN Key</td> </tr> <tr> <td>Button 22</td> <td>DN Key</td> </tr> <tr> <td>Button 21</td> <td>DN Key</td> </tr> <tr> <td>Button 10</td> <td>DN Key</td> </tr> <tr> <td>Button 9</td> <td>DN Key</td> </tr> </table>	Button 24	DN Key	Button 23	DN Key	Button 22	DN Key	Button 21	DN Key	Button 10	DN Key	Button 9	DN Key
Button 24	DN Key												
Button 23	DN Key												
Button 22	DN Key												
Button 21	DN Key												
Button 10	DN Key												
Button 9	DN Key												

#### Button Assignments 1 ~ 24 ...

Assign a key function to each Flexible button.

(Default: DN Key)

#### • One Touch:

Used as an alias to a favorite number.

You can assign a frequently used telephone number, a special number, prefix, and so on.

- ① You can enter an external phone number with a prefix to use a special number for a Transceiver Individual Call.

Button 24	One Touch
	3000*101

#### • DN key: (Directory Number)

Checks the line assigned to the DN button. When a call arrives on the DN button, pressing the button answers the call.

Be sure to assign 2 or more DN keys.

#### The indicator status

- Quickly blinks green: An external or an extension call has arrived
- Slowly blinks green: Holding on your terminal
- Lights green: The line is in use on your terminal

- ① The shared line is assigned to the order of the DN key button number.

- ① The number of sharable lines are the total number of DN keys. Also, it depends on the setting on the “External Call Limiting” screen. (PBX Advanced Settings > External Call Limiting)

**Note:** At least two DN keys are required, the one for incoming or talking, the other one for holding or keeping a call. Be sure to assign enough DN keys to manage the shared lines.

## Telephone (KX-UT Series) screen

### PBX Extension > Telephone (KX-UT Series)

#### ■ Button Assignment

Button Assignment	
<div style="border: 1px solid black; padding: 2px;">           Buttons 13            One Touch  <b>DN Key</b>            External Call Status            Call Fwd Always            Call Fwd No Answer            Call Fwd Busy            Headset            Not used         </div>	Button 24 DN Key <span style="float: right;">▼</span>
Button 10	Button 23
DN Key <span style="float: right;">▼</span>	DN Key <span style="float: right;">▼</span>
Button 9	Button 22
DN Key <span style="float: right;">▼</span>	DN Key <span style="float: right;">▼</span>
	Button 21
	DN Key <span style="float: right;">▼</span>

#### Button Assignments 1 ~ 24 (Continued)

##### • External Call Status

Checks the assigned External line (IP line) status. When a call arrives on the External Call Status button, pressing the button answers the call.

Button 12
External Call Status <span style="float: right;">▼</span>
100 (IP) <span style="float: right;">▼</span>

##### The indicator status

- Blinks red: An External Call is incoming or held
- Lights red: The line is in use on another terminal
- Lights green: The line is in use on your terminal

① Assign the same number of External Call Status buttons as the channels you are allowed.

## Telephone (KX-UT Series) screen

### PBX Extension > Telephone (KX-UT Series)

#### ■ Button Assignment

Button Assignment									
<div style="border: 1px solid black; padding: 2px;">           Buttons 10-24            One Touch  <b>DN Key</b>            External Call Status            Call Fwd Always            Call Fwd No Answer            Call Fwd Busy            Headset            Not used         </div>	<table border="1"> <tr> <td>Button 24</td> <td>DN Key</td> </tr> <tr> <td>Button 23</td> <td>DN Key</td> </tr> <tr> <td>Button 22</td> <td>DN Key</td> </tr> <tr> <td>Button 21</td> <td>DN Key</td> </tr> </table>	Button 24	DN Key	Button 23	DN Key	Button 22	DN Key	Button 21	DN Key
Button 24	DN Key								
Button 23	DN Key								
Button 22	DN Key								
Button 21	DN Key								
Button 10	DN Key								
Button 9	DN Key								

#### Button Assignments 1 ~ 24 (Continued)

##### • Call Fwd Always

Forwards incoming calls to the specified extension while the indicator on this key lights red. Enter the extension number (with a special number, if required) of the forwarding destination. Push the button to start or stop forwarding.

##### The indicator status

- Lights red: Forwards calls
- Not lit: Does not forward calls

- ① You can also start or stop forwarding by dialing the special number for “Call Forward Always” (Default: \*94) and the extension number of the forwarding destination.  
(PBX > Special Number > Telephone Special Number > Call Forward Always)

##### • Call Fwd No Answer

Forwards an incoming call to the specified extension when you don't answer the call for a certain period of time, such as when you are busy on another call. Enter the extension number (with a special number, if required) of the forwarding destination. Push the button to start or stop forwarding.

##### The indicator status

- Lights red: Forwards calls
- Not lit: Does not forward calls

- ① You can also start or stop forwarding by dialing the special number for “Call Forward No Answer” (Default: \*95) and the extension number of the forwarding destination.  
(PBX > Special Number > Telephone Special Number > Call Forward No Answer)

## Telephone (KX-UT Series) screen

### PBX Extension > Telephone (KX-UT Series)

#### ■ Button Assignment

Button Assignment	
<div style="border: 1px solid black; padding: 2px;">           Buttons 13            One Touch  <b>DN Key</b>            External Call Status            Call Fwd Always            Call Fwd No Answer            Call Fwd Busy            Headset            Not used         </div>	Button 24 DN Key <span style="float: right;">▼</span>
Button 10	Button 23
DN Key <span style="float: right;">▼</span>	DN Key <span style="float: right;">▼</span>
Button 9	Button 22
DN Key <span style="float: right;">▼</span>	DN Key <span style="float: right;">▼</span>
	Button 21
	DN Key <span style="float: right;">▼</span>

#### Button Assignments 1 ~ 24 (Continued)

##### • Call Fwd Busy

Forwards an incoming call to the specified extension when you are busy on another call.

Enter the extension number (with a special number, if required) of the forwarding destination.

Push the button to start or stop forwarding.

##### The indicator status

- Lights red: Forwards calls
- Not lit: Does not forward calls

- ① You can also start or stop forwarding by dialing the special number of “Call Forward Busy” (Default: \*96) and the extension number of forwarding destination.  
(PBX > Special Number > Telephone Special Number > Call Forward Busy)

##### • Headset

Assign to talk using a headset if it is connected to the KX series telephone. The indicator lights red while the headset is in use.

##### • Not used

Does not assign any function.

## Telephone (KX-HDV Series) screen

PBX Extension > Telephone (KX-HDV Series)

### ■ Telephone Maintenance

Assigns a Group to each extension number.

The settings for each extension detail can be edited in “List of Extension Entries” (PBX > Extension > List of Extension Entries).

<input type="checkbox"/> All ①	Extension Number ②	Port Type ③	Status ④	Group ⑤	⑥
<input type="checkbox"/>	31	SIP Phone (Automatic Detection)	Connected	Group 1 ▼	Reboot
<input type="checkbox"/>	32	SIP Phone (Automatic Detection)	Connected	Group 1 ▼	Reboot
<input type="checkbox"/>	33	SIP Phone (Automatic Detection)	Not Connected	Group 1 ▼	Reboot
<input type="checkbox"/>	34	SIP Phone (Automatic Detection)	Not Connected	Group 1 ▼	Reboot
	3000	Transceiver Controller Telephone Connection	--	Group 1 ▼	

⑦ Reboot Selected    ⑧ Reboot All  
⑨ Apply    ⑩ Reset

- ① **Check Box** ..... Click to select the extensions if you want to reboot one or more KX series telephones. Click “All” to select all the entries.  
 ① The extensions where Status (④) is “Not Connected” cannot be selected.
  
- ② **Extension Number**..... Displays the extension number.
  
- ③ **Port Type** ..... Displays the port type of the telephone.
  
- ④ **Status** ..... Displays the connection status of the telephone.  
 ① “Not Connected” is displayed for the telephone that is not registered to the SIP server of this RoIP gateway.  
 ① “—” is displayed for the Converter bridge or the Transceiver Controller Telephone Connection.
  
- ⑤ **Group** ..... Set the setting Group of the extension.  
 You can customize the flexible function button assignments for each Group. (Default: Group 1)  
 • Range: Group 1 ~ 30

## Telephone (KX-HDV Series) screen

PBX Extension > Telephone (KX-HDV Series)

### ■ Telephone Maintenance

**Telephone Maintenance**

<input type="checkbox"/> All <sup>1</sup>	Extension Number <sup>2</sup>	Port Type <sup>3</sup>	Status <sup>4</sup>	Group <sup>5</sup>	<sup>6</sup>
<input type="checkbox"/>	31	SIP Phone (Automatic Detection)	Connected	Group 1 ▼	Reboot
<input type="checkbox"/>	32	SIP Phone (Automatic Detection)	Connected	Group 1 ▼	Reboot
<input type="checkbox"/>	33	SIP Phone (Automatic Detection)	Not Connected	Group 1 ▼	Reboot
<input type="checkbox"/>	34	SIP Phone (Automatic Detection)	Not Connected	Group 1 ▼	Reboot
	3000	Transceiver Controller Telephone Connection	--	Group 1 ▼	

<sup>7</sup> Reboot Selected
<sup>8</sup> Reboot All  
<sup>9</sup> Apply
<sup>10</sup> Reset

- <sup>6</sup> **<Reboot>** ..... Click to reboot the KX series telephone.
- <sup>7</sup> **<Reboot Selected>** ..... Click to reboot the selected (with check marks) KX series telephones.
- <sup>8</sup> **<Reboot All>** ..... Click to reboot all the KX series telephones whose Status (<sup>4</sup>) is "Connected" in the list.
- <sup>9</sup> **<Apply>** ..... Click to apply the entries.
- <sup>10</sup> **<Reset>** ..... Click to reset the settings.  
 ⓘ You cannot reset after clicking <Apply>.

## Telephone (KX-HDV Series) screen

PBX Extension > Telephone (KX-HDV Series)

### ■ Telephone Group

Edits the Group setting of the entered extension (telephone.)

<b>Telephone Group</b>	
Select Group Setting :	Common Setting <input type="button" value="Edit"/>

#### Select Group Setting .....

Select the setting mode, and then click <Edit>.

- The setting screen for the selected Group is displayed.

- **Common Setting**

Common settings for the KX-HDV Series that are connected to the RoIP gateway, such as the tone patterns or volume levels.

- **Group 1 ~ Group 30**

The custom settings for the KX-HDV Series in the selected Group that are connected to the RoIP gateway, such as the flexible button assignments.

## Telephone (KX-HDV Series) screen

PBX Extension > Telephone (KX-HDV Series)

### ■ Dial Tone Common Setting

Sets the tone when off-hook.

**Dial Tone**

---

Frequency 1: 1 350 Hz

Frequency 2: 440 Hz

Level: 2 0 dB

Repeat: 3  Disable  Enable  Continuous Sound

Timing: 4

OFF	ON	OFF	ON	OFF	ON	OFF	ON	OFF
60	0							

- 1 Frequency 1/2** ..... Set the tone frequencies of the Dial tone. (Default: Frequency 1: 350 / Frequency 2: 440)

  - Range: 0 (inaudible), 200 ~ 2000 (Hz)
  - ① The 350 Hz and 440 Hz tones simultaneously sound at default.
- 2 Level** ..... Set the audio level of the Dial tone. (Default: 0)

  - Range: -24 (minimum) ~ +6 (maximum) (dB)
- 3 Repeat** ..... Set whether or not to repeat the set tone pattern. (Default: Continuous Sound)

  - **Disable:** Sounds the set pattern in Timing 4 only once
  - **Enable:** Continuously repeats the set pattern in Timing 4
  - **Continuous Sound:** Continuously sounds frequencies 1 and 2
- 4 Timing** ..... Set the pattern of tone rings and mutes using up to 9 values. The tone sounds for the set period of time in the ON settings, and mutes for the set period of time in the OFF settings. (Default: 60, 0)

  - Range of the first "OFF": 60 ~ 16000 (milliseconds)
  - Range of the others: 51 ~ 16000 (milliseconds)



## Telephone (KX-HDV Series) screen

PBX Extension > Telephone (KX-HDV Series)

### ■ Busy Tone Common Setting

Sets the tone when the line is busy.

**Busy Tone**

Frequency 1 : ① 480 Hz

Frequency 2 : 620 Hz

Level : ② 0 dB

Repeat : ③  Disable  Enable  Continuous Sound

Timing : ④

OFF	ON	OFF	ON	OFF	ON	OFF	ON	OFF
60	500	440						

- ① **Frequency 1/2** ..... Set the tone frequencies of the Busy tone. (Default: Frequency 1: 480 / Frequency 2: 620)

  - Range: 0 (inaudible), 200 ~ 2000 (Hz)
  - ① The 480 Hz and 620 Hz tones simultaneously sound at default.
  
- ② **Level** ..... Set the audio level of the Busy tone. (Default: 0)

  - Range: -24 (minimum) ~ +6 (maximum) (dB)
  
- ③ **Repeat** ..... Set whether or not to repeat the set tone pattern. (Default: Enable)

  - **Disable:** Sounds the set pattern in Timing ④ only once
  - **Enable:** Continuously repeats the set pattern in Timing ④
  - **Continuous Sound:** Continuously sounds frequencies 1 and 2
  
- ④ **Timing** ..... Set the pattern of tone rings and mutes using up to 9 values. The tone sounds for the set period of time in the ON settings, and mutes for the set period of time in the OFF settings. (Default: 60, 500, 440)

  - Range of the first "OFF": 60 ~ 16000 (milliseconds)
  - Range of the others: 51 ~ 16000 (milliseconds)

## Telephone (KX-HDV Series) screen

PBX Extension > Telephone (KX-HDV Series)

### ■ Reorder Tone Common Setting

Sets the Reorder tone.

**Reorder Tone**

Frequency 1 : ① 480 Hz

Frequency 2 : 620 Hz

Level : ② 0 dB

Repeat : ③  Disable  Enable  Continuous Sound

Timing : ④

OFF	ON	OFF	ON	OFF	ON	OFF	ON	OFF
.60	250	.190						

- ① **Frequency 1/2** ..... Set the tone frequencies of the Reorder tone. (Default: Frequency 1: 480 / Frequency 2: 620)

  - Range: 0 (inaudible), 200 ~ 2000 (Hz)
  - ① The 480 Hz and 620 Hz tones simultaneously sound at default.
  
- ② **Level** ..... Set the audio level of the Reorder tone. (Default: 0)

  - Range: -24 (minimum) ~ +6 (maximum) (dB)
  
- ③ **Repeat** ..... Set whether or not to repeat the set tone pattern. (Default: Enable)

  - **Disable:** Sounds the set pattern in Timing (④) only once
  - **Enable:** Continuously repeats the set pattern in Timing (④)
  - **Continuous Sound:** Continuously sounds frequencies 1 and 2
  
- ④ **Timing** ..... Set the pattern of tone rings and mutes using up to 9 values. The tone sounds for the set period of time in the ON settings, and mutes for the set period of time in the OFF settings. (Default: 60, 250, 190)

  - Range of the first "OFF": 60 ~ 16000 (milliseconds)
  - Range of the others: 51 ~ 16000 (milliseconds)

## Telephone (KX-HDV Series) screen

PBX Extension > Telephone (KX-HDV Series)

### Ring Back Tone Common Setting

Sets the Ringback tone.

**Ring Back Tone**

---

Frequency 1 : 440 Hz

Frequency 2 : 480 Hz

Level : 0 dB

Repeat :  Disable  Enable  Continuous Sound

Timing : 60 2000 3940

- 1 Frequency 1/2** ..... Set the tone frequencies of the Ringback tone. (Default: Frequency 1: 440 / Frequency 2: 480)

  - Range: 0 (inaudible), 200 ~ 2000 (Hz)
  - ① The 440 Hz and 480 Hz tones simultaneously sound at default.
  
- 2 Level** ..... Set the audio level of the Ringback tone. (Default: 0)

  - Range: -24 (minimum) ~ +6 (maximum) (dB)
  
- 3 Repeat** ..... Set whether or not to repeat the set tone pattern. (Default: Enable)

  - **Disable:** Sounds the set pattern in Timing (4) only once
  - **Enable:** Continuously repeats the set pattern in Timing (4)
  - **Continuous Sound:** Continuously sounds frequencies 1 and 2
  
- 4 Timing** ..... Set the pattern of tone rings and mutes using up to 9 values. The tone sounds for the set period of time in the ON settings, and mutes for the set period of time in the OFF settings. (Default: 60, 2000, 3940)

  - Range of the first "OFF": 60 ~ 16000 (milliseconds)
  - Range of the others: 51 ~ 16000 (milliseconds)

## Telephone (KX-HDV Series) screen

PBX Extension > Telephone (KX-HDV Series)

### ■ Hold Alarm Common Setting

Sets the Hold alarm tone that sounds to alert you a second call has been held for certain period of time.

Hold Alarm	
Frequency 1: ①	425 Hz
Frequency 2:	0 Hz
Level: ②	0 ▼ dB

- ① **Frequency 1/2** ..... Set the tone frequencies of the Hold alarm.  
(Default: Frequency 1: 425 / Frequency 2: 0)
  - Range: 0 (inaudible), 200 ~ 2000 (Hz)
- ② **Level** ..... Set the audio level of the Hold alarm. (Default: 0)
  - Range: -24 (minimum) ~ +6 (maximum) (dB)

## Telephone (KX-HDV Series) screen

PBX Extension > Telephone (KX-HDV Series)

### Ringtone Pattern Common Setting

Sets the Ringtone patterns. The Ringtone patterns can be assigned to the

**Ringtone Pattern**

\*Unit of Ringtone set values shown are in milliseconds.

Pattern 1 : 

ON	OFF	ON	OFF	ON	OFF	ON	OFF
2000	4000						

Pattern 2 : 

ON	OFF	ON	OFF	ON	OFF	ON	OFF
800	400	800	4000				

Pattern 3 : 

ON	OFF	ON	OFF	ON	OFF	ON	OFF
400	200	400	200	800	4000		

Pattern 4 : 

ON	OFF	ON	OFF	ON	OFF	ON	OFF
300	200	1000	200	300	4000		

Pattern 5 : 

ON	OFF	ON	OFF	ON	OFF	ON	OFF
2000	4000						

#### Pattern 1 ~ 5.....

Set the pattern of tone rings and mutes using up to 8 values. The tone sounds for the set period of time in the ON settings, and mutes for the set period of time in the OFF settings.

#### ○ The default values of Ringtone Patterns

Pattern	ON	OFF	ON	OFF	ON	OFF	ON	OFF
Pattern 1	2000	4000	-	-	-	-	-	-
Pattern 2	800	400	800	4000	-	-	-	-
Pattern 3	400	200	400	200	800	4000	-	-
Pattern 4	300	200	1000	200	300	4000	-	-
Pattern 5	2000	4000	-	-	-	-	-	-

- Range : 51 ~ 5000 (milliseconds)
- ① A ring pattern must end with OFF.
- ① The ring patterns can be assigned, according to the incoming call type.  
See the next item for details.

## Telephone (KX-HDV Series) screen

PBX Extension > Telephone (KX-HDV Series)

### ■ Ringtone Pattern Assignment Common Setting

Assigns the Ringtone pattern of each incoming call group.

Ringtone Pattern Assignment		
Outside Line A :	Pattern 1	▼
Outside Line B :	Pattern 2	▼
Outside Line C :	Pattern 3	▼
Extension A :	Pattern 5	▼
Extension B :	Pattern 4	▼
Extension C :	Pattern 3	▼
Extension Assignment :	Pattern 2	▼
Hold Recall :	Pattern 2	▼
		<input type="button" value="Apply"/> <input type="button" value="Reset"/>

Assign a Ringtone pattern for each incoming call type according to the setting on the Inbound Call screen. (PBX > Inbound Call)

#### ① Information

- The incoming call group depends on the notified number of incoming calls.
- The calls from the phone numbers that are entered into extensions A to C are treated as internal calls.
- For an internal call from other than the entered extensions on the Inbound Call screen, the Ringtone pattern set in the “Extension Assignment” sounds.
- When recalling to a parked telephone, the Ringtone set in the “Hold Recall” sounds.

## Telephone (KX-HDV Series) screen

PBX Extension > Telephone (KX-HDV Series)

### ■ Telephone Common Settings Group 1 ~ 30

Sets the rules for incoming calls for each Extension Group.

Telephone Common Settings	
Pickup Group Number :	<span style="border: 1px solid black; border-radius: 50%; padding: 2px;">1</span> 01
Call Pickup Target :	<span style="border: 1px solid black; border-radius: 50%; padding: 2px;">2</span> Extension Only <span style="float: right;">▼</span>
Group Pickup Target :	<span style="border: 1px solid black; border-radius: 50%; padding: 2px;">3</span> External Call/Extension <span style="float: right;">▼</span>
Directed Call Pickup Target :	<span style="border: 1px solid black; border-radius: 50%; padding: 2px;">4</span> External Call/Extension <span style="float: right;">▼</span>
Call Restriction :	<span style="border: 1px solid black; border-radius: 50%; padding: 2px;">5</span> Disable <span style="float: right;">▼</span>

- 1 Pickup Group Number .....** Enter a pick up group number of up to 7 digit.  
(Default: 01 (for the Group1))

① You can pick up an incoming call of another group extension by dialing the Special Number for the Group Pickup and the Group Number of the group. (For example: Dial "\*\*\*01" to pick up the call to Group 1.)
- 2 Call Pickup Target .....** Set the incoming call type that the group can pick up.  
(Default: Extension Only)

  - Options: Extension Only, External Call Only, or External Call/Extension
- 3 Group Pickup Target.....** Set the incoming call type that you can pick up, that arrives at an extension in the same Group. (Default: External Call/Extension)

  - Options: Extension Only, External Call Only, or External Call/Extension
- 4 Directed Call Pickup Target** Set the type of directed call that you can pick up, that arrives at an extension in the same Group. (Default: External Call/Extension)

  - Options: Extension Only, External Call Only, or External Call/Extension
- 5 Call Restriction .....** Select whether or not to restrict making an external call.  
(Default: Disable)

  - **Disable:** You can make external calls.
  - **Call Restriction Rule 1 ~ 16:** Restricts external calls according to the rules. The rules can be set in "Outbound Call Restriction Rule Settings."  
(PBX Advanced Settings > Numbering Plan > Outbound Call Restriction Rule Settings)
  - **External Call Restriction:** You cannot make any external calls but you can make internal calls (including Peer to Peer calls.)

## Telephone (KX-HDV Series) screen

PBX Extension > Telephone (KX-HDV Series)

### ■ Telephone Individual Settings (KX-HDV Series) Group 1 ~ 30

Sets the rules for the incoming calls, and so on, to each Extension group.

**Telephone Individual Settings (KX-HDV Series)**

Dial Waiting Time : ① 5 ▼ seconds

Accept Internal Calls while on an External Call : ②  Refuse  Allow

Accept External Calls without Button Assignment : ③  Refuse  Allow

Holding a Call with the External Call Status Button : ④  Refuse  Allow

Long-Hold Watch Time : ⑤ 180 seconds

Phonebook Sharing : ⑥  Disable  Enable

Common Phonebook Sharing : ⑦  Disable  Enable

- ① Dial Waiting Time** ..... The waiting time to start dialing after you finished dialing. (Default: 5)  
 • Range: 1 ~ 15 (seconds)
- ② Accept Internal Calls while on an External Call** ..... Set whether or not to accept an incoming extension call (including a Peer to Peer call) while you are talking on an external call. (Default: Refuse)  
 ① When setting to “Refuse,” the busy tone will be returned to an incoming extension call.
- ③ Accept External Calls without Button Assignment** Set whether or not to accept an inbound call to a <DN key> or <Not Used> button when an <External Call Status> button is not assigned or all <External Call Status> buttons are busy. (Default: Allow)  
 • **Allow:** Accepts an inbound call to a <DN key> or a <Not used> button.  
 • **Refuse:** Rejects an inbound call and returns the busy tone.
- ④ Holding a Call with the External Call Status Button** When selecting “Allow,” you can hold an external call using an <External Call Status> button. (Default: Refuse)
- ⑤ Long-Hold Watch Time**..... Sounds an alert if you hold a call for time longer than the set period of time. (Default: 180)  
 • Range: 30 ~ 240 (seconds)



## Telephone (KX-HDV Series) screen

### PBX Extension > Telephone (KX-HDV Series)

#### ■ Telephone Individual Settings (KX-HDV Series)

**Telephone Individual Settings (KX-HDV Series)**

---

Dial Waiting Time : ① 5 ▼ seconds

Accept Internal Calls while on an External Call : ②  Refuse  Allow

Accept External Calls without Button Assignment : ③  Refuse  Allow

Holding a Call with the External Call Status Button : ④  Refuse  Allow

Long-Hold Watch Time : ⑤ 180 seconds

Phonebook Sharing : ⑥  Disable  Enable

Common Phonebook Sharing : ⑦  Disable  Enable

#### ⑥ Phonebook Sharing .....

Set whether or not to download the Phonebook data from the RoIP gateway at every boot up of a KX series telephone.

You can download up to 300 entries to the common phonebook and up to 100 entries to the Group phonebook. (Default: Enable)

① If disabling this setting, the phonebook is not downloaded even if the SIP phone is booted up.

#### ⑦ Common Phonebook Sharing

Displayed only when “Phonebook Sharing” (⑥) is enabled.

Set whether or not to download the Common Phonebook data from the RoIP gateway at every boot up of KX series telephones.

(Default: Enable)

## Telephone (KX-HDV Series) screen

### PBX Extension > Telephone (KX-HDV Series)

#### ■ Telephone Individual Settings (KX-HDV Series)

Telephone Individual Settings (KX-HDV Series)		
[Not selected, [Transfer], [Blind Transfer], or [Conference] is selected. The KX-HDV series button works as [DN Key].]		
Button Assignment (Page 1) 9		
Index	Button Type	Button Label
12	DN Key	DN Key
11	External Call Status	DN Key
10	Call Fwd Always	DN Key
9	Call Fwd No Answer	DN Key
8	Call Fwd Busy	DN Key
7	Transfer	DN Key
6	Blind Transfer	DN Key
5	Conference	DN Key
	Not used	DN Key
	DN Key	DN Key
	DN Key	DN Key
	DN Key	DN Key

#### 9 Button Assignments 1 ~ 24

Assign a key function to each Flexible button.

(Default: DN Key)

##### • One Touch:

Used as an alias to a favorite number.

You can assign a frequently used telephone number, a special number, prefix, and so on.

The entered Button Label will be displayed on the KX-HDV series telephone.

① You can enter an external phone number with a prefix to use a special number for an external call.

24	One Touch	3000*101	Individual 101
----	-----------	----------	----------------

## Telephone (KX-HDV Series) screen

### PBX Extension > Telephone (KX-HDV Series)

#### ■ Telephone Individual Settings (KX-HDV Series)

Telephone Individual Settings (KX-HDV Series)		
Button Assignment (Page 1) 9		
Index	Button Type	Button Label
12	DN Key	DN Key
11	External Call Status	DN Key
10	Call Fwd Always	DN Key
9	Call Fwd No Answer	DN Key
8	Call Fwd Busy	DN Key
7	Transfer	DN Key
6	Blind Transfer	DN Key
5	Conference	DN Key
	Not used	DN Key

#### 9 Button Assignments 1 ~ 24 (Continued)

##### • DN key: (Directory Number)

Checks the line assigned to the DN button. When a call arrives on the DN button, pressing the button answers the call. Be sure to assign 2 or more DN keys.

##### The indicator status

- Quickly blinks blue: An external or an extension call has arrived
- Slowly blinks blue: Holding on your terminal
- Lights blue: The line is in use on your terminal

- ① The shared line is assigned to the order of the DN key button number.
- ① The number of sharable lines are the total number of DN keys. Also it depends on the setting on the "External Call Limiting" screen. (PBX Advanced Settings > External Call Limiting)

**Note:** At least two DN keys are required, the one for incoming or talking, the other one for holding or keeping a call. Be sure to assign enough DN keys to manage the shared lines.

##### • External Call Status

Checks the assigned External line (IP line) status. When a call arrives on the External Call Status button, pressing the button answers the call.

12	External Call Status	100 (IP)	External Call Status
----	----------------------	----------	----------------------

##### The indicator status

- Blinks red: An External Call is incoming or held
- Lights red: The line is in use

- ① Assign the same number of External Call Status buttons as the channels you are allowed.

## Telephone (KX-HDV Series) screen

### PBX Extension > Telephone (KX-HDV Series)

#### ■ Telephone Individual Settings (KX-HDV Series)

Telephone Individual Settings (KX-HDV Series)		
Button Assignment (Page 1)		
Index	Button Type	Button Label
12	DN Key	DN Key
11	External Call Status	DN Key
10	Call Fwd Always	DN Key
9	Call Fwd No Answer	DN Key
8	Call Fwd Busy	DN Key
7	Transfer	DN Key
6	Blind Transfer	DN Key
5	Conference	DN Key
	Not used	DN Key

#### ⑨ Button Assignments 1 ~ 24 (Continued)

##### • Call Fwd Always

Forwards incoming calls to the specified extension while the indicator on this key lights red. Enter the extension number (with a special number, if required) of the forwarding destination. Push the button to start or stop forwarding.

##### The indicator status

- Lights red: Forwards calls
- Not lit: Does not forward calls

① You can also start or stop forwarding by dialing the special number for “Call Forward Always” (Default: \*94) and the extension number of the forwarding destination.  
(PBX > Special Number > Telephone Special Number > Call Forward Always)

##### • Call Fwd No Answer

Forwards an incoming call to the specified extension when you don't answer the call for a certain period of time, such as when you are busy on another call. Enter the extension number (with a special number, if required) of the forwarding destination. Push the button to start or stop forwarding.

##### The indicator status

- Lights red: Forwards calls
- Not lit: Does not forward calls

① You can also start or stop forwarding by dialing the special number for “Call Forward No Answer” (Default: \*95) and the extension number of the forwarding destination.  
(PBX > Special Number > Telephone Special Number > Call Forward No Answer)

## Telephone (KX-HDV Series) screen

### PBX Extension > Telephone (KX-HDV Series)

#### ■ Telephone Individual Settings (KX-HDV Series)

Telephone Individual Settings (KX-HDV Series)		
Button Assignment (Page 1) 9		
Index	Button Type	Button Label
12	DN Key	DN Key
11	External Call Status	DN Key
10	Call Fwd Always	DN Key
9	Call Fwd No Answer	DN Key
8	Call Fwd Busy	DN Key
7	Transfer	DN Key
6	Blind Transfer	DN Key
5	Conference	DN Key
	Not used	DN Key
	DN Key	DN Key
	DN Key	DN Key
	DN Key	DN Key

#### 9 Button Assignments 1 ~ 24 (Continued)

##### • Call Fwd Busy

Forwards an incoming call to the specified extension when you are busy on another call.

Enter the extension number (with a special number, if required) of the forwarding destination.

Push the button to start or stop forwarding.

##### The indicator status

- Lights red: Forwards calls
- Not lit: Does not forward calls

① You can also start or stop forwarding by dialing the special number of “Call Forward Busy” (Default: \*96) and the extension number of forwarding destination.

(PBX > Special Number > Telephone Special Number > Call Forward Busy)

## Telephone (KX-HDV Series) screen

### PBX Extension > Telephone (KX-HDV Series)

#### ■ Telephone Individual Settings (KX-HDV Series)

Telephone Individual Settings (KX-HDV Series)		
[Not selected, transfer], [blind transfer], or [conference] is selected. The KX-HDV Series button works as [DN Key].		
Button Assignment (Page 9)		
Index	Button Type	Button Label
12	DN Key	DN Key
11	External Call Status	DN Key
10	Call Fwd Always	DN Key
9	Call Fwd No Answer	DN Key
8	Call Fwd Busy	DN Key
7	Transfer	DN Key
6	Blind Transfer	DN Key
5	Conference	DN Key
	Not used	DN Key
	DN Key	DN Key
	DN Key	DN Key
	DN Key	DN Key

#### ⑨ Button Assignments 1 ~ 24 (Continued)

- **Transfer**  
Holds and forwards a call to the specified extension. After the forwarding destination answers, push [OK] or hang up to transfer a call.
- **Blind Transfer**  
Holds and immediately forwards a call to the specified extension. Enter the extension number of the destination and hang up the telephone.
- **Conference**  
Holds a call and makes a conference call to the specified extension. Enter the extension number of the destination. After the destination answers, push the <CONF> button to start the conference call.
- **Not used**  
Does not assign any function.

## Expand Unit (KX-HDV230) Expand Unit 1 ~ 5 screen

PBX Extension > Expand Unit (KX-HDV230) Expand Unit 1 ~ 5

### ■ Telephone Maintenance

Enters the common phonebook or the phonebook that is shared in the particular Group for the KX series SIP phones. The settings of each extension details can be edited in “List of Extension Entries” (PBX > Extension > List of Extension Entries).

Telephone Maintenance					
<input type="checkbox"/> All 1	Extension Number 2	Port Type 3	Status 4	Group 5	6
<input type="checkbox"/>	31	SIP Phone (Automatic Detection)	Connected	Group 1 v	Reboot
<input type="checkbox"/>	32	SIP Phone (Automatic Detection)	Connected	Group 1 v	Reboot
<input type="checkbox"/>	33	SIP Phone (Automatic Detection)	Not Connected	Group 1 v	Reboot
<input type="checkbox"/>	34	SIP Phone (Automatic Detection)	Not Connected	Group 1 v	Reboot
	3000	Transceiver Controller Telephone Connection	--	Group 1 v	

7 Reboot Selected    8 Reboot All  
9 Apply    10 Reset

- 1 Check Box** ..... Click to select the extensions if you want to reboot one or more KX series telephones. Click “All” to select all the entries.  
 ① The extensions where Status (4) is “Not Connected” cannot be selected.
- 2 Extension Number** ..... Displays the extension number.
- 3 Port Type** ..... Displays the port type of the telephone.
- 4 Status** ..... Displays the connection status of the telephone.  
 ① “Not Connected” is displayed for the telephone that is not registered to the SIP server of this RoIP gateway.  
 ① “--” is displayed for the Converter Bridge or the Transceiver Controller Telephone Connection.
- 5 Group** ..... Set the line Group of the extension.  
 You can customize the flexible function button assignments for each Group. Assign the same Group if you want to use the button functions from other telephones by dialing the special number and button number.  
 (For example: When picking up a parked telephone call)  
 • Range: Group 1 ~ 30

## Expand Unit (KX-HDV230) Expand Unit 1 ~ 5 screen

PBX Extension > Expand Unit (KX-HDV230) Expand Unit 1 ~ 5

### ■ Telephone Maintenance

**Telephone Maintenance**

<input type="checkbox"/> All <sup>1</sup>	Extension Number <sup>2</sup>	Port Type <sup>3</sup>	Status <sup>4</sup>	Group <sup>5</sup>	<sup>6</sup>
<input type="checkbox"/>	31	SIP Phone (Automatic Detection)	Connected	Group 1 ▼	Reboot
<input type="checkbox"/>	32	SIP Phone (Automatic Detection)	Connected	Group 1 ▼	Reboot
<input type="checkbox"/>	33	SIP Phone (Automatic Detection)	Not Connected	Group 1 ▼	Reboot
<input type="checkbox"/>	34	SIP Phone (Automatic Detection)	Not Connected	Group 1 ▼	Reboot
	3000	Transceiver Controller Telephone Connection	--	Group 1 ▼	

Reboot Selected <sup>7</sup>
Reboot All <sup>8</sup>  
Apply <sup>9</sup>
Reset <sup>10</sup>

- <sup>6</sup> <Reboot> ..... Click to reboot the KX series telephone.
- <sup>7</sup> <Reboot Selected> ..... Click to reboot the selected (with check marks) KX series telephones.
- <sup>8</sup> <Reboot All> ..... Click to reboot all the KX series telephones whose Status (<sup>4</sup>) is "Connected" in the list.
- <sup>9</sup> <Apply> ..... Click to apply the entries.
- <sup>10</sup> <Reset> ..... Click to reset the settings.  
 ⓘ You cannot reset after clicking <Apply>.



Expand Unit (KX-HDV230) Expand Unit 1 ~ 5 screen

PBX Extension > Expand Unit (KX-HDV230) Expand Unit 1 ~ 5

## ■ Telephone Group

Edits the Group setting of the entered extension (telephone)

Telephone Group	
Select Group Setting :	Group 1 <input type="button" value="Edit"/>

**Select Group Setting .....**

Select a Group from Group 1 to Group 30 that you want to edit, and then click <Edit> to enter the edit mode.

## Expand Unit (KX-HDV230) Expand Unit 1 ~ 5 screen

PBX Extension > Expand Unit (KX-HDV230) Expand Unit 1 ~ 5

### ■ Telephone Individual Settings (KX-HDV230)

Assigns the function to each flexible button on the expand units 1 to 5.

Button Assignment (Page 1)			
Index	Button Type	Button Information	Button Label
10	DN Key One Touch <b>DN Key</b>		DN Key
9	External Call Status Call Fwd Always Call Fwd No Answer Call Fwd Busy Transfer Blind Transfer Conference Not used		DN Key
8			DN Key
7			DN Key
6			DN Key
5			DN Key
4	DN Key		DN Key
3	DN Key		DN Key
2	DN Key		DN Key
1	DN Key		DN Key

#### Button Assignment .....

- Expand Unit 1 (1 ~ 40)
- Expand Unit 2 (41 ~ 80)
- Expand Unit 3 (81 ~ 120)
- Expand Unit 4 (121 ~ 160)
- Expand Unit 5 (161 ~ 200)

Assign a button function to each flexible button.

The Assignable functions:

- **One Touch**
- **DN Key (Directory Number)\***
- **External Call Status\***
- **Call Fwd Always\***
- **Call Fwd No Answer\***
- **Call Fwd Busy\***
- **Transfer**
- **Blind Transfer**
- **Conference**
- **Not used**

\* Assignable only to Expand unit 1 (Button 1 ~ 40)

① Refer to the "Button Assignment" on pages 13-33 ~13-37 for details on each button function.

## Phonebook screen

PBX Extension > Phonebook

### ■ Select Group Setting

Edits the phonebook to the Common phonebook and the Group phonebooks.

**Select Group Setting**

<div style="border: 1px solid gray; padding: 2px; margin-bottom: 5px;">Common</div> <p>0 Items</p>				
<div style="border: 1px solid gray; padding: 2px; margin-bottom: 5px;">Group 1</div> <p>0 Items</p>	<div style="border: 1px solid gray; padding: 2px; margin-bottom: 5px;">Group 2</div> <p>0 Items</p>	<div style="border: 1px solid gray; padding: 2px; margin-bottom: 5px;">Group 3</div> <p>0 Items</p>	<div style="border: 1px solid gray; padding: 2px; margin-bottom: 5px;">Group 4</div> <p>0 Items</p>	<div style="border: 1px solid gray; padding: 2px; margin-bottom: 5px;">Group 5</div> <p>0 Items</p>
<div style="border: 1px solid gray; padding: 2px; margin-bottom: 5px;">Group 6</div> <p>0 Items</p>	<div style="border: 1px solid gray; padding: 2px; margin-bottom: 5px;">Group 7</div> <p>0 Items</p>	<div style="border: 1px solid gray; padding: 2px; margin-bottom: 5px;">Group 8</div> <p>0 Items</p>	<div style="border: 1px solid gray; padding: 2px; margin-bottom: 5px;">Group 9</div> <p>0 Items</p>	<div style="border: 1px solid gray; padding: 2px; margin-bottom: 5px;">Group 10</div> <p>0 Items</p>
<div style="border: 1px solid gray; padding: 2px; margin-bottom: 5px;">Group 11</div> <p>0 Items</p>	<div style="border: 1px solid gray; padding: 2px; margin-bottom: 5px;">Group 12</div> <p>0 Items</p>	<div style="border: 1px solid gray; padding: 2px; margin-bottom: 5px;">Group 13</div> <p>0 Items</p>	<div style="border: 1px solid gray; padding: 2px; margin-bottom: 5px;">Group 14</div> <p>0 Items</p>	<div style="border: 1px solid gray; padding: 2px; margin-bottom: 5px;">Group 15</div> <p>0 Items</p>
<div style="border: 1px solid gray; padding: 2px; margin-bottom: 5px;">Group 16</div> <p>0 Items</p>	<div style="border: 1px solid gray; padding: 2px; margin-bottom: 5px;">Group 17</div> <p>0 Items</p>	<div style="border: 1px solid gray; padding: 2px; margin-bottom: 5px;">Group 18</div> <p>0 Items</p>	<div style="border: 1px solid gray; padding: 2px; margin-bottom: 5px;">Group 19</div> <p>0 Items</p>	<div style="border: 1px solid gray; padding: 2px; margin-bottom: 5px;">Group 20</div> <p>0 Items</p>
<div style="border: 1px solid gray; padding: 2px; margin-bottom: 5px;">Group 21</div> <p>0 Items</p>	<div style="border: 1px solid gray; padding: 2px; margin-bottom: 5px;">Group 22</div> <p>0 Items</p>	<div style="border: 1px solid gray; padding: 2px; margin-bottom: 5px;">Group 23</div> <p>0 Items</p>	<div style="border: 1px solid gray; padding: 2px; margin-bottom: 5px;">Group 24</div> <p>0 Items</p>	<div style="border: 1px solid gray; padding: 2px; margin-bottom: 5px;">Group 25</div> <p>0 Items</p>
<div style="border: 1px solid gray; padding: 2px; margin-bottom: 5px;">Group 26</div> <p>0 Items</p>	<div style="border: 1px solid gray; padding: 2px; margin-bottom: 5px;">Group 27</div> <p>0 Items</p>	<div style="border: 1px solid gray; padding: 2px; margin-bottom: 5px;">Group 28</div> <p>0 Items</p>	<div style="border: 1px solid gray; padding: 2px; margin-bottom: 5px;">Group 29</div> <p>0 Items</p>	<div style="border: 1px solid gray; padding: 2px; margin-bottom: 5px;">Group 30</div> <p>0 Items</p>

The Common Phonebook (up to 300 items) will be registered to all the SIP Phones.  
 Group 1-30 (up to 100 items) will be registered to the SIP Phones of the corresponding group.

#### Select Group Setting .....

Click the button that you want to edit its phonebook.

- ① The entries in the selected phonebook are displayed in the “List of Phonebook Entries” below on the screen. (See page 13-47.)
- ① The number of entries are displayed below the Group buttons.
- ① You can edit the Group setting in “Telephone Maintenance.”  
 (PBX Extension > Telephone (KX-UT Series) > Telephone Maintenance)  
 (PBX Extension > Telephone (KX-HDV Series) > Telephone Maintenance)

## Phonebook screen

PBX Extension > Phonebook

### ■ Save or Write the Phonebook

You can save or load the selected phonebook to or from a CSV format file.

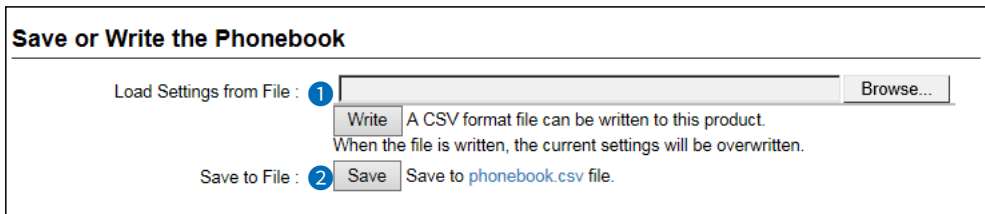

#### 1 Load Settings from File ...

You can load the saved phonebook from a CSV format file. Click <Browse> and select the setting file (phonebook.csv) from the displayed list, and then click <Open>. Confirm the correct file is selected, and then click <Write> to load the phonebook from the selected file.

- ① Note that the phonebook settings will be overwritten when the phonebook is loaded.
- ① The setting backup file on the "Settings Backup/Restore" includes the phonebook data. If the setting file is loaded on the "Settings Backup/Restore" screen (Management > Settings Backup/Restore > Settings Restore), the phonebook settings will be overwritten.
- ① A file that is saved by other than the following procedures may not work properly:
  - Saved file using the <Save> (2) button.
  - A CSV file in the same format as described on the next page.

#### 2 Save to File .....

Saves the settings in the "List of Phonebook Entries," on the screen, to a CSV format file.

Click <Save> and select a folder to save the file into.

- ① You can edit the saved file in a spreadsheet.
- ① The saved file name depends on the selected Group.  
(For example: The phonebook for Group 1 is saved to phonebook01.csv)

## Phonebook screen

### PBX Extension > Phonebook

#### ■ Save or Write the Phonebook

##### ○ About the rules of a CSV file for the phonebook

When editing a saved CSV file, be sure to observe the following rules. Otherwise the phonebook settings may not load properly into the RoIP gateway.

	A	B	C	D	E	F	G	H	I	J
1	#	VE-PG4	Phonebook	config file						
2	#	Firm Ver.								
3	#	File Ver.								
4	#No.	Name	Phone Number	-	-	Nickname	Speed Dial	Display Type (0=Phone Number/1=Speed Dial Number)	Line Type(0=Outside call/1=Extension)	group
5	1	Sales 1	tel:0123456788			Sales 1	tel:201		0	0 1
6	2	Sales 2	tel:0123456789			Sales 2	tel:202		0	0 1
7	3	John Smith	tel:0123456790			John	tel:		0	0 1
8										

Column	Title	Description
A	Index	1 ~ 300 for the Common phonebook, 1 ~ 100 for a Group phonebook Do not duplicate the number.
B	Name	Up to 30 characters
C	Phone Number	"tel:" and up to 22 digits or prefix
D	- (Reserved)	Do not edit or delete this column.
E	- (Reserved)	Do not edit or delete this column.
F	Nickname	Up to 30 characters
G	Speed Dial Number	"tel:" and up to 7 characters, leave blank if you do not use the Speed Dial Number.
H	Display Type	0: Phone Number, 1: Speed Dial Number
I	Line Type	0: External line, 1: Extension Do not edit or delete this column.
J	group	1 ~ 10 Do not edit or delete this column.

- The lines that begins with "#" are comments.
- Delete unnecessary lines.

## Phonebook screen

PBX Extension > Phonebook

### ■ Phonebook Entry

You can enter frequently used or commonly used phone numbers into a phonebook. Refer to the Installation guide for details on using a phonebook.

1 **Index** .....

Select a number from the list.  
 • Range for the Common phonebook: 1 ~ 300  
 • Range for the Group phonebooks: 1 ~ 100

2 **Name\*** .....

Enter a destination name of up to 30 characters.

3 **Nickname\*** .....

Enter a nickname of up to 30 characters.

4 **Phone Number\*** .....

Enter the telephone number (with a special number and prefix, if required) of the destination.  
 ① You cannot enter an alias number of up to 22 digits with a special number or a prefix.

5 **Speed Dial Number** .....

Enter an alias number of up to 7 digits.  
 The Speed Dial Number is used when making an external call, or a Peer to Peer call (that does not go through the SIP server.)  
 ① You cannot dial a Speed Dial Number after any special number and/or a prefix.  
 ① A Speed Dial Number is usable on the line that is set in "Extension."  
 ① The Speed Dial Number is usable for telephones other than the KX series.

#### About the Speed Dial numbers

Setting numbers other than the emergency telephone numbers in your area are recommended as Speed Dial numbers.

\*Required to enter a phonebook.

## Phonebook screen

### PBX Extension > Phonebook

#### ■ Phonebook Entry

**Phonebook Entry**  
Index: ① 1  
Name: ② \_\_\_\_\_  
Nickname: ③ \_\_\_\_\_  
Phone Number: ④ \_\_\_\_\_  
Speed Dial Number: ⑤ \_\_\_\_\_  
Display Type: ⑥ Phone Number  
⑦ Apply ⑧ Reset

- ⑥ **Display Type** ..... Select "Phone Number" or "Speed Dial Number" to display a phonebook on the telephone. (Default: Phone Number)
- ⑦ **<Apply>** ..... Click to apply the entries.
- ⑧ **<Reset>** ..... Click to reset the settings.  
① You cannot reset after clicking <Apply>.

## Phonebook screen

PBX Extension > Phonebook

### ■ List of Phonebook Entries

Lists the phonebook entries.

List of Phonebook Entries						
Index	Name	Nickname	Phone Number	Speed Dial Number	Display Type	
1	Sales 1	Sales 1	0101234567	201	Phone Number	<span>1</span> Edit <span>2</span> Delete
2	Sales 2	Sales 2	0101234568	202	Phone Number	Edit Delete
3	John Smith	John	0101234578		Phone Number	Edit Delete

3 Delete All

**1 <Edit>** .....

Click to edit an entry.

**2 <Delete>** .....

Click to delete an entry.

ⓘ You cannot restore after clicking <Delete>.

**3 <Delete All>** .....

Click to delete all the entries.

ⓘ You cannot restore after clicking <Delete All>.



## Transceiver Controller Telephone Connection screen

PBX Extension > Transceiver Controller Telephone Connection

### ■ Transceiver Controller Telephone Connection

Settings for communication between an IP transceiver and a SIP phone.

Transceiver Controller Telephone Connection	
Extension Number :	3000

**Extension Number** ..... Displays the extension number of the Transceiver Controller Telephone Connection that is set in "Extension."  
(PBX > Extension > Extension)

## Transceiver Controller Telephone Connection screen

PBX Extension > Transceiver Controller Telephone Connection

### ■ Communication

Settings to communicate between a SIP phone and a transceiver that belongs to a group set in the RoIP gateway.

Communication	
Default Callee ID	
Call Type : ①	Group <input type="button" value="v"/>
Destination ID : ②	1

- ① Call Type** ..... Set the call type to send from a SIP phone to a transceiver that belongs to the RoIP gateway. (Default: Group)
  - Options: Individual, Group, or All
  
- ② Destination ID** ..... Does not displayed when the Call Type (①) is set to "All."  
Enter the Individual ID or Group ID of the destination transceiver. (Default: 1)
  - Range: 1 ~ 9999

## Transceiver Controller Telephone Connection screen

PBX Extension > Transceiver Controller Telephone Connection

### Control

The settings for communication control between a SIP phone and a transceiver that are linked to the RoIP gateway.

Control	
PTT Call Cancel on Call Incoming	<input type="radio"/> Disable <input checked="" type="radio"/> Enable
Target Availability Check	<input checked="" type="radio"/> Disable <input type="radio"/> Enable
Timing of Target Availability Check	<input checked="" type="radio"/> After Call <input type="radio"/> Prior to Call
<b>Notice Tone on the Transceiver</b>	
Call Incoming	Not used <span style="float:right">▼</span>
Calling	Notice Tone 2 <span style="float:right">▼</span>
Connection Success	Notice Tone 2 <span style="float:right">▼</span>
Disconnect	Notice Tone 3 <span style="float:right">▼</span>
Connection Failure	Notice Tone 3 <span style="float:right">▼</span>
Notice Tone Volume	0 <span style="float:right">▼ dB</span>

- 1 PTT Call Cancel on Call Incoming** ..... Select "Enable" to cancel the current call if a SIP phone receives another call from the same transceiver while a call is incoming. (Default: Disable)
- 2 Target Availability Check** ... Select whether or not to check the availability of a destination transceiver when a SIP phone makes a call to it. If this setting is enabled, the RoIP gateway will stop sending a call to a linked transceiver if the destination transceiver is busy, or it does not answer in 5 seconds. (Default: Enable)
- 3 Timing of Target Availability Check** ..... Set when the Target Availability Check (2) will occur. (Default: After Call)
- **After Call:** Checks after a call is established
  - **Prior to Call:** Checks before a call is established

## Transceiver Controller Telephone Connection screen

### PBX Extension > Transceiver Controller Telephone Connection

#### ■ Control

**Control**

---

PTT Call Cancel on Call Incoming: 1  Disable  Enable

Target Availability Check: 2  Disable  Enable

Timing of Target Availability Check: 3  After Call  Prior to Call

**Notice Tone on the Transceiver**

Call Incoming: 4 Not used ▼

Calling: 5 Notice Tone 2 ▼

Connection Success: 6 Notice Tone 2 ▼

Disconnect: 7 Notice Tone 3 ▼

Connection Failure: 8 Notice Tone 3 ▼

Notice Tone Volume: 9 0 ▼ dB

- 4 **Call Incoming** ..... Select a Notice Tone to send to notify a transceiver that a call from a SIP phone has arrived. (Default: Not used)

  - **Not used:** Does not send a Notice Tone (The transceiver automatically answers.)
  - **Notice Tone 1 ~ 3:** Sends the selected Notice Tone (The transceiver can answer by pushing [PTT] between the Notice Tones.)
  
- 5 **Calling** ..... The Notice Tone to send to a transceiver while calling a target SIP phone. (Default: Notice Tone 2)
  
- 6 **Connection Success** ..... The Notice Tone to send to a transceiver alerting that the target SIP phone answered the call. (Default: Notice Tone 2)
  
- 7 **Disconnect** ..... The Notice Tone to send to a transceiver alerting that the target SIP phone has hung up the call. (Default: Notice Tone 3)
  
- 8 **Connection Failure** ..... The Notice Tone to send to a transceiver alerting that the call could arrive at the target SIP phone. (Default: Notice Tone 3)
  
- 9 **Notice Tone Volume** ..... Set the volume level of the Notice Tones (4 ~ 8). (Default: 0)

  - Range: -12 (minimum) ~ +6 (maximum) (dB)

## Transceiver Controller Telephone Connection screen

### PBX Extension > Transceiver Controller Telephone Connection

#### ■ Control

PTT Control Type	
Group Call/All Call	⑪ VOX
Individual Call to a Wireless LAN Transceiver	⑫ VOX
Individual Call to a IP Transceiver	⑬ VOX
Individual Call to a Digital Transceiver	⑭ VOX
Individual Call to an EXT (Transceiver)	⑮ DTMF
Individual Call to an EXT (EXT I/O Unit)	⑯ VOX
Individual Call to a Microphone	⑰ VOX
PTT-ON Tone	⑱ 0
PTT-OFF Tone	⑲ 0
Call Initiation Control	
Method	⑳ RTP

⑩ “PTT-ON Tone” (⑱) and “PTT-OFF Tone” (⑲) are displayed only when any PTT Control Types from “Group Call/All Call” (⑪) to “Individual Call to a Microphone” (⑰) are set to “DTMF.”

#### ○ PTT Control Type

Sets the type of signal that SIP phones use to communicate for each call type or destination device type.

- Options: VOX (Voice signal,) DTMF (Tone signal,) or Constant Transmission during Call

⑩ When “Constant Transmission during Call” is selected, the No Voice Release Timer detects the communication status only by the signal received from the specified destination.

(PBX Extension > Transceiver Controller Telephone Connection > Release Timer)

If a signal from the specified destination is not received for the set period of time, the call may be terminated because of the No Voice Release Timer function.

#### ⑪ Group Call/ All Call .....

Set the signal type for Group Calls and All Calls to the linked transceivers. (Default: VOX)

- **VOX:** When a voice signal is received from a SIP phone, the target transceiver enters the transmit mode.
- **DTMF:** When a tone signal is received from a SIP phone, the target transceiver enters the transmit mode.
- **Constant Transmission during Call:** As soon as the communication is established, the target transceiver enters the transmit mode. The No Voice Release Timer detects only the signal (VOX or RTP) received from the Converter Bridge connection destination.

#### ⑫ Individual Call to a Wireless LAN Transceiver

Set the signal type for Individual calls to Wireless LAN transceivers. (Default: VOX)

- **VOX:** When detecting a voice signal from a SIP phone, the target Wireless LAN transceiver enters the **receive** mode.
- **DTMF:** When detecting a tone signal from a SIP phone, the target Wireless LAN transceiver enters the **receive** mode.
- **Constant Transmission during Call:** As soon as the communication is established, the target Wireless LAN transceiver enters the **receive** mode. The No Voice Release Timer detects only the signal (VOX or RTP) received from the Wireless LAN transceiver.

## Transceiver Controller Telephone Connection screen

### PBX Extension > Transceiver Controller Telephone Connection

#### Control

<b>PTT Control Type</b>	
Group Call/All Call : 11	VOX
Individual Call to a Wireless LAN Transceiver : 12	VOX
Individual Call to a IP Transceiver : 13	VOX
Individual Call to a Digital Transceiver : 14	VOX
Individual Call to an EXT (Transceiver) : 15	DTMF
Individual Call to an EXT (EXT I/O Unit) : 16	VOX
Individual Call to a Microphone : 17	VOX
PTT-ON Tone : 18	0
PTT-OFF Tone : 19	0
<b>Call Initiation Control</b>	
Method : 20	RTP

① “PTT-ON Tone” (18) and “PTT-OFF Tone” (19) are displayed only when any PTT Control Types from “Group Call/All Call” (11) to “Individual Call to a Microphone” (17) are set to “DTMF.”

#### 13 Individual Call to a IP Transceiver .....

Set the signal type for Individual calls to IP transceivers.

(Default: VOX)

- **VOX:** When detecting a voice signal from a SIP phone, the target IP transceiver enters the receive mode.
- **DTMF:** When detecting a tone signal from a SIP phone, the target IP transceiver enters the receive mode.
- **Constant Transmission during Call:**  
As soon as the communication is established, the target IP transceiver enters the receive mode.  
The No Voice Release Timer detects only the signal (VOX or RTP) received from the IP transceiver.

#### 14 Individual Call to a Digital Transceiver .....

Set the signal type for Individual Calls to digital transceivers.

(Default: VOX)

- **VOX:** When a voice signal is received from a SIP phone, the digital transceiver enters the transmit mode.
- **DTMF:** When a tone signal is received from a SIP phone, the digital transceiver enters the transmit mode.
- **Constant Transmission during Call:**  
As soon as the communication is established, the digital transceiver enters the receive mode.  
The No Voice Release Timer detects only the signal (VOX or RTP) received from the digital transceiver.

#### 15 Individual Call to an EXT (Transceiver) .....

Set the signal type for Individual Calls to EXT (transceivers.)

(Default: VOX)

- **VOX:** When a voice signal is received from a SIP phone, the EXT (transceiver) enters the transmit mode.
- **DTMF:** When a tone signal is received from a SIP phone, the EXT (transceiver) enters the transmit mode.
- **Constant Transmission during Call:**  
As soon as the communication is established, the EXT (transceiver) enters the receive mode.  
The No Voice Release Timer detects only the signal (VOX or RTP) received from the EXT (transceiver.)

## Transceiver Controller Telephone Connection screen

### PBX Extension > Transceiver Controller Telephone Connection

#### ■ Control

<b>PTT Control Type</b>	
Group Call/All Call : ⑪	VOX
Individual Call to a Wireless LAN Transceiver : ⑫	VOX
Individual Call to a IP Transceiver : ⑬	VOX
Individual Call to a Digital Transceiver : ⑭	VOX
Individual Call to an EXT (Transceiver) : ⑮	DTMF
Individual Call to an EXT (EXT I/O Unit) : ⑯	VOX
Individual Call to a Microphone : ⑰	VOX
PTT-ON Tone : ⑱	0
PTT-OFF Tone : ⑲	0
<b>Call Initiation Control</b>	
Method : ⑳	RTP

⑩ “PTT-ON Tone” (⑱) and “PTT-OFF Tone” (⑲) are displayed only when any PTT Control Types from “Group Call/All Call” (⑪) to “Individual Call to a Microphone” (⑰) are set to “DTMF.”

#### ⑯ Individual Call to an EXT (EXT I/O Unit) .....

Set the signal type for Individual Calls to EXT (I/O units.)  
(Default: VOX)

- **VOX:** When a voice signal is received from a SIP phone, the EXT (I/O unit) enters the transmit mode.
- **DTMF:** When a tone signal is received from a SIP phone, the EXT (I/O unit) enters the transmit mode.
- **Constant Transmission during Call:**  
As soon as communication is established, the EXT (I/O unit) enters the transmit mode.  
The No Voice Release Timer detects only the signal (VOX or RTP) received from the EXT (I/O unit.)

#### ⑰ Individual Call to a Microphone .....

Set the signal type for Individual Calls to a speaker microphone.  
(Default: VOX)

- **VOX:** When a voice signal is received from a SIP phone, the speaker microphone enters the receive mode.
- **DTMF:** When a tone signal is received from a SIP phone, the speaker microphone enters the receive mode.
- **Constant Transmission during Call:**  
As soon as communication is established, the microphone enters the receive mode.  
The No Voice Release Timer detects only the signal (VOX or RTP) received from the speaker microphone.

## Transceiver Controller Telephone Connection screen

### PBX Extension > Transceiver Controller Telephone Connection

#### ■ Control

<b>PTT Control Type</b>	
Group Call/All Call :	(11) VOX
Individual Call to a Wireless LAN Transceiver :	(12) VOX
Individual Call to a IP Transceiver :	(13) VOX
Individual Call to a Digital Transceiver :	(14) VOX
Individual Call to an EXT (Transceiver) :	(15) DTMF
Individual Call to an EXT (EXT I/O Unit) :	(16) VOX
Individual Call to a Microphone :	(17) VOX
PTT-ON Tone :	(18) 0
PTT-OFF Tone :	(19) 0
<b>Call Initiation Control</b>	
Method :	(20) RTP

① “PTT-ON Tone” (18) and “PTT-OFF Tone” (19) are displayed only when any PTT Control Types from “Group Call/All Call” (11) to “Individual Call to a Microphone” (17) are set to “DTMF.”

- 18 PTT-ON Tone** ..... Select the PTT-ON tone when any signal types shown above (11 ~ 17) is set to “DTMF.” (Default: 0)
- Range: 0 ~ 9, \*, or #
- ① Dial this number on the SIP phone to make a destination device start transmitting.
- ① If you enter the same value in both the PTT-ON Tone and the PTT-OFF Tone, you can toggle the destination device status by dialing this number.
- 19 PTT-OFF Tone** ..... Select the PTT-OFF tone when any signal types shown above (11 ~ 17) is set to “DTMF.” (Default: 0)
- Range: 0 ~ 9, \*, or #
- ① Dial this tone on the SIP phone to make the destination device to stop transmitting.
- ① If you enter the same value in both the PTT-ON Tone and PTT-OFF Tone, you can toggle the destination device status by dialing this number.
- 20 Method** ..... Set the transmitting trigger to make a call from a transceiver controller to the IP telephone system. (Default: RTP)
- **VOX:** Starts dialing when the VOX detects voice data in the voice packet that is received by the bridge interface through the RTP (Real-time Transport Protocol).
  - **RTP:** Starts dialing when the RTP (voice data packet) is longer than the set period time in the Attack Time setting is received, regardless of if the RTP includes voice data or not.



## Transceiver Controller Telephone Connection screen

PBX Extension > Transceiver Controller Telephone Connection

### ■ PTT Control Setting

The VOX (voice operated transmission) function automatically switches the connected transceiver to transmit, when the RoIP gateway receives an audio signal through the network.

PTT Control Setting		
*Setting values of Attack Time, Release Time and Voice Delay are set in five milliseconds steps.		
Attack Time : ①	50	milliseconds
Release Time : ②	500	milliseconds
Voice Delay : ③	200	milliseconds
VOX Threshold : ④	40	%

- ① Attack Time** ..... Enter the TX delay time. (Default: 50)

  - Range: 5 ~ 500 (milliseconds) in 5 millisecond steps

After the continuous signal for the set period of time is received from a SIP phone, the transceiver controller starts to transmit.
  
- ② Release Time** ..... Select the RX delay time. (Default: 500)

  - Range: 5 ~ 2000 (milliseconds) in 5 millisecond steps

This is the delay time for the VOX to turn OFF, after no audio signal is received through the network.
  
- ③ Voice Delay** ..... Set the audio signal buffer time to prevent intermittent audio. (Default: 200)

  - Range: 0 ~ 1500 (milliseconds) in 5 millisecond steps

The voice delay is the amount of time the RoIP gateway stores the transmitted audio to prevent missing the first part of the speech.
  
- ④ VOX Threshold** ..... Set the voice threshold level. (Default: 40)

  - Range: 0 ~ 100 (%)

The VOX function automatically switches between receive and transmit according to this threshold level. The lower values make the VOX function more sensitive to the voice input.

## Transceiver Controller Telephone Connection screen

PBX Extension > Transceiver Controller Telephone Connection

### ■ Call Initiation Setting

Sets the details on voice transmission to the SIP phone when there is voice input from the transceiver controller.

Call Initiation Setting	
*Setting values of Attack Time, Release Time and Voice Delay are set in five milliseconds steps.	
Attack Time : ①	1000 milliseconds
Release Time : ②	200 milliseconds
Voice Delay : ③	5 milliseconds
VOX Threshold : ④	70 %

- ① Attack Time** ..... Enter the TX attack time in 5 millisecond step. It is the delay time before the VOX switch turns ON after an audio signal is received through the network. (Default: 1000)

  - Range: 5 ~ 2000 (milliseconds) in 5 millisecond steps
  
- ② Release Time** ..... Select the RX delay time in 5 millisecond step. It is the delay time for the VOX switch to turn OFF after no audio signal is received through the network. (Default: 200)

  - Range: 5 to 2000 (milliseconds) in 5 millisecond steps
  
- ③ Voice Delay** ..... Set the audio signal buffer time to prevent intermittent audio. (Default: 5)

  - Range: 0 ~ 500 (milliseconds) in 5 millisecond steps
  
- ④ VOX Threshold** ..... The VOX function automatically switches between receive and transmit according to this threshold level. (Default: 70)

  - Range: 0 ~ 100 (%)
  - ① Lower values make the VOX function more sensitive to the audio signal.

## Transceiver Controller Telephone Connection screen

PBX Extension > Transceiver Controller Telephone Connection

### ■ Notice Tone on the Telephone

Sets the details on the notification to a SIP phone, when a call has arrived on a transceiver controller from a SIP phone.

Notice Tone on the Telephone		
Connection Success: ①	Notice Tone 1	▼
PTT Monitoring: ②	Not used	▼
Notice Tone Volume: ③	0	▼ dB

- ① Connection Success** ..... Select a Notice Tone to notify a SIP phone that a call has arrived on the transceiver controller and the SIP phone is ready to transmit. (Default: Notice Tone 1)

  - **Not used:** Does not send a Notice Tone
  - **Notice Tone 1 ~ 3:** Sends the selected Notice Tone
  
- ② PTT Monitoring** ..... Select a Notice Tone to alert you to switch receiving and transmitting. (Default: Not used)

  - **Not used:** Does not send a Notice Tone
  - **Notice Tone 1 ~ 3:** Sends the selected Notice Tone
  
- ③ Notice Tone Volume** ..... Set the volume level of the Notice Tones (① ~ ②). (Default: 0)

  - Range: -12 (minimum) ~ +6 (maximum) (dB)

## Transceiver Controller Telephone Connection screen

PBX Extension > Transceiver Controller Telephone Connection

### ■ Release Timer

Sets the timers for canceling or disconnecting a call.

Release Timer	
Call Cancel Timer : ① 15	seconds
No Voice Release Timer : ② 15	seconds
Forced Disconnect	
Forced Disconnect Timer : ③ 10	minutes
<input type="button" value="Apply"/> <input type="button" value="Reset"/>	

- ① Call Cancel Timer** ..... Enter the period of time to cancel the call. When the set time has passed without a response from the SIP phone, the call is canceled. (Default: 15)

  - Range: 0 (OFF) or 5 ~ 60 (seconds)
  
- ② No Voice Release Timer** ... Enter the period of time to stop transmitting. When the set time has passed with no audio signal, transmitting is stopped. (Default: 15)

  - Range: 0 (OFF) or 5 ~ 600 (seconds)
  
- ③ Forced Disconnect Timer** Enter the period of time to be forcibly stop transmitting. When the set time has passed, transmitting is stopped, even when communication is ongoing. (Default: 10)

  - Range: 0 (OFF) or 5 ~ 120 (minutes)

## Converter Bridge screen

PBX Extension > Converter Bridge

### ■ Converter Bridge

Selects a extension whose settings you want to edit settings in the “Connection” item below.

Converter Bridge	
Extension Number :	(Converter Bridge1) ▼

**Extension Number .....** Displays the extension number of the Converter Bridge, if it is set in “Extension” (PBX > Extension > Extension.)

## Converter Bridge screen

PBX Extension > Converter Bridge

### ■ Connection

Sets the destination device of the bridge connection that connects to the SIP phones

**Connection**

Transmission Mode: ① Multicast ▼

Destination Address: ② 239.255.255.1

Destination Port Number: ③ 22510

Source Port Number: ④ 22510

Voice Protocol: ⑤ G.711u  
\*Voice Protocol can be set on the Bridge Connection.

Multicast TTL: ⑥ 1

Connection Status: ⑦ Inactive Activate Refresh

① The screen above is when the Transmission Mode (①) is set to "Multicast".

- ① **Transmission Mode** ..... Set the transmission mode on each extension (port) number.  
(Default: Unicast)
  
- ② **Destination Address** ..... Set an appropriate IP address, depending on the Transmission Mode (①) setting.
  - **For Unicast:** Set the IP address for the LAN, or the domain name of the destination, that of up to 63 characters.  
(Default: Blank)
  - **For Multicast:** Set the same value as the bridge setting of the call destination.  
(Default: 239.255.255.1)
  
- ③ **Destination Port Number** ... Set the same port number as the "Source Port Number" (④) setting of the VE-PG4 that works as the Converter Bridge connection Destination.
  - Range: An even number from 2 to 65534.

① Do not duplicate other connection port settings.

#### ○ The Default port settings in the Unicast mode

PORT	DEFAULT	PORT	DEFAULT
Converter Bridge 1	24200	Converter Bridge 11	24220
Converter Bridge 2	24202	Converter Bridge 12	24222
Converter Bridge 3	24204	Converter Bridge 13	24224
Converter Bridge 4	24206	Converter Bridge 14	24226
Converter Bridge 5	24208	Converter Bridge 15	24228
Converter Bridge 6	24210	Converter Bridge 16	24230
Converter Bridge 7	24212	Converter Bridge 17	24232
Converter Bridge 8	24214	Converter Bridge 18	24234
Converter Bridge 9	24216	Converter Bridge 19	24236
Converter Bridge 10	24218	Converter Bridge 20	24238

## Converter Bridge screen

### PBX Extension > Converter Bridge

#### ■ Connection

**Connection**

Transmission Mode: ① Multicast ▼

Destination Address: ② 239.255.255.1

Destination Port Number: ③ 22510

Source Port Number: ④ 22510

Voice Protocol: ⑤ G.711u  
\*Voice Protocol can be set on the Bridge Connection.

Multicast TTL: ⑥ 1

Connection Status: ⑦ Inactive Activate Refresh

① The screen above is when the Transmission Mode (①) is set to "Multicast".

#### ③ Destination Port Number (Continued)

##### ○ The Default port settings in the Multicast mode

PORT	DEFAULT	PORT	DEFAULT
Converter Bridge 1	22510	Converter Bridge 11	22510
Converter Bridge 2	22510	Converter Bridge 12	22510
Converter Bridge 3	22510	Converter Bridge 13	22510
Converter Bridge 4	22510	Converter Bridge 14	22510
Converter Bridge 5	22510	Converter Bridge 15	22510
Converter Bridge 6	22510	Converter Bridge 16	22510
Converter Bridge 7	22510	Converter Bridge 17	22510
Converter Bridge 8	22510	Converter Bridge 18	22510
Converter Bridge 9	22510	Converter Bridge 19	22510
Converter Bridge 10	22510	Converter Bridge 20	22510

#### ④ Source Port Number .....

Set the same port number as the setting in the Converter Bridge connection destination.

- Range: An even number from 2 to 65534

① Do not duplicate other connection port settings, when using in the Unicast mode.

##### ○ The Default port settings in the Unicast mode

PORT	DEFAULT	PORT	DEFAULT
Converter Bridge 1	24200	Converter Bridge 11	24220
Converter Bridge 2	24202	Converter Bridge 12	24222
Converter Bridge 3	24204	Converter Bridge 13	24224
Converter Bridge 4	24206	Converter Bridge 14	24226
Converter Bridge 5	24208	Converter Bridge 15	24228
Converter Bridge 6	24210	Converter Bridge 16	24230
Converter Bridge 7	24212	Converter Bridge 17	24232
Converter Bridge 8	24214	Converter Bridge 18	24234
Converter Bridge 9	24216	Converter Bridge 19	24236
Converter Bridge 10	24218	Converter Bridge 20	24238

## Converter Bridge screen

### PBX Extension > Converter Bridge

#### ■ Connection

**Connection**

Transmission Mode: ① Multicast ▼

Destination Address: ② 239.255.255.1

Destination Port Number: ③ 22510

Source Port Number: ④ 22510

Voice Protocol: ⑤ G.711u  
\*Voice Protocol can be set on the Bridge Connection.

Multicast TTL: ⑥ 1

Connection Status: ⑦ Inactive Activate Refresh

① The screen above is when the Transmission Mode is set to “Multicast”.

#### ④ Source Port Number (Continued)

##### ○ The Default port settings in the Multicast mode

PORT	DEFAULT	PORT	DEFAULT
Converter Bridge 1	22510	Converter Bridge 11	22510
Converter Bridge 2	22510	Converter Bridge 12	22510
Converter Bridge 3	22510	Converter Bridge 13	22510
Converter Bridge 4	22510	Converter Bridge 14	22510
Converter Bridge 5	22510	Converter Bridge 15	22510
Converter Bridge 6	22510	Converter Bridge 16	22510
Converter Bridge 7	22510	Converter Bridge 17	22510
Converter Bridge 8	22510	Converter Bridge 18	22510
Converter Bridge 9	22510	Converter Bridge 19	22510
Converter Bridge 10	22510	Converter Bridge 20	22510

#### ⑤ Voice Protocol .....

Displays the assigned Voice Protocol in the “AMBE+2 Vocoder Assignment” setting.  
 (Bridge Connection Setting > Bridge Connection > AMBE+2 Vocoder Assignment)

#### ⑥ Multicast TTL .....

Displayed only when Transmission Mode (①) is set to “Multicast.”  
 For the expiration data of the voice packet, set the TTL (Time To Live) until the voice packet reaches the communication destination.  
(Default: 1)

- Range: 1 ~ 255

#### ⑦ Connection Status.....

Displays the status of the Converter Bridge connection. Click <Refresh> to reload the status, or <Activate> to activate the set devices.  
 ① After they are successfully activated, the button changes to “Inactivate.”





## Converter Bridge screen

PBX Extension > Converter Bridge

### Control

The settings for the communication control between the RoIP gateway and a Converter Bridge connection destination.

Control	
Prioritized Receive :	① <input type="radio"/> Disable <input checked="" type="radio"/> Enable
PTT Call Cancel on Call Incoming :	② <input checked="" type="radio"/> Disable <input type="radio"/> Enable
Target Availability Check :	③ <input type="radio"/> Disable <input checked="" type="radio"/> Enable
Timing of Target Availability Check :	④ <input checked="" type="radio"/> After Call <input type="radio"/> Prior to Call
<b>Notice Tone on the Transceiver</b>	
Call Incoming :	⑤ Not used <span style="float: right;">▼</span>
Dialing Notice Tone on the Transceiver :	⑥ Not used <span style="float: right;">▼</span>
Calling :	⑦ Notice Tone 2 <span style="float: right;">▼</span>
Connection Success :	⑧ Notice Tone 2 <span style="float: right;">▼</span>
Disconnect :	⑨ Notice Tone 3 <span style="float: right;">▼</span>
Connection Failure :	⑩ Notice Tone 3 <span style="float: right;">▼</span>
Notice Tone Volume :	⑪ 0 <span style="float: right;">▼ dB</span>

- ① Prioritized Receive** ..... Select "Enable" to inhibit a SIP phone from transmitting an RTP signal while it is receiving an RTP signal from a Converter Bridge connection destination. (Default: Disable)
- ② PTT Call Cancel on Call Incoming** ..... Select "Enable" to cancel the current call if a SIP phone receives another call from the same Converter Bridge connection destination while a call is incoming. (Default: Disable)
- ③ Target Availability Check ...** Displayed only when the voice protocol setting on the Converter Bridge is set to "Bridge Protocol" or "Protocol for Transceiver and SIP Phone connection" in the "AMBE+2 Vocoder Assignment." (Bridge Connection Settings > Bridge Connection > AMBE+2 Vocoder Assignment > Converter Bridge 1 ~ 20)  
Select whether or not to check the availability of a Converter Bridge connection destination when a device such as SIP phone linked to this RoIP gateway makes a call (excluding an emergency call) to it. If this setting is enabled, the RoIP gateway will stop sending a call to a linked transceiver when the destination transceiver is busy, or it does not answer in 5 seconds. (Default: Enable)
- ④ Timing of Target Availability Check** ..... Set when the Target Availability Check (③) will occur. (Default: After Call)
- **After Call:** Checks after a call is established
  - **Prior to Call:** Checks before a call is established

## Converter Bridge screen

### PBX Extension > Converter Bridge

#### ■ Control

**Control**

Prioritized Receive : ①  Disable  Enable

PTT Call Cancel on Call Incoming : ②  Disable  Enable

Target Availability Check : ③  Disable  Enable

Timing of Target Availability Check : ④  After Call  Prior to Call

**Notice Tone on the Transceiver**

Call Incoming : ⑤ Not used ▼

Dialing Notice Tone on the Transceiver : ⑥ Not used ▼

Calling : ⑦ Notice Tone 2 ▼

Connection Success : ⑧ Notice Tone 2 ▼

Disconnect : ⑨ Notice Tone 3 ▼

Connection Failure : ⑩ Notice Tone 3 ▼

Notice Tone Volume : ⑪ 0 ▼ dB

- ⑤ Call Incoming** ..... Select a Notice Tone to send to notify a client transceiver that a call from a SIP phone has arrived. (Default: Not used)

  - **Not used:** Does not send a Notice Tone (The transceiver automatically answers.)
  - **Notice Tone 1 ~ 3:** Sends the selected Notice Tone (The transceiver can answer by pushing [PTT] between the Notice Tones.)
  
- ⑥ Dialing Notice Tone on the Transceiver** ..... Displayed when the “DTMF Dialig” (on the screen) is enabled. (Default: Not used)
  
- ⑦ Calling** ..... The Notice Tone to send to a caller transceiver alerting that the target SIP phone answered the call. (Default: Notice Tone 2)
  
- ⑧ Connection Success**..... The Notice Tone to send to a caller transceiver alerting that the target SIP phone has hung up the call. (Default: Notice Tone 2)
  
- ⑨ Disconnect** ..... The Notice Tone to send to a caller transceiver alerting that the call could arrive at the target SIP phone. (Default: Notice Tone 3)
  
- ⑩ Connection Failure** ..... The Notice Tone to send to a caller transceiver alerting that the call could arrive at the target SIP phone. (Default: Notice Tone 3)
  
- ⑪ Notice Tone Volume** ..... Set the volume level of the Notice Tones (⑤ ~ ⑩). (Default: 0)

  - Range: -12 (minimum) ~ +6 (maximum) (dB)

## Converter Bridge screen

### PBX Extension > Converter Bridge

#### ■ Control

Control	
PTT Control Type	PTT Control Type : 12 DTMF
	PTT-ON Tone : 13 0
	PTT-OFF Tone : 14 0
Call Initiation Control	Method : 15 RTP

① “PTT-ON Tone” (13) and “PTT-OFF Tone” (14) are displayed only when “PTT Control Type” (12) is set to “DTMF.”

#### 12 PTT Control Type .....

Sets the type of signal that SIP phones use to communicate for each call type or destination device type. (Default: VOX)

- **VOX:** When a voice signal is received from a SIP phone, the target transceiver enters the transmit mode.
- **DTMF:** When a tone signal is received from a SIP phone, the target transceiver enters the transmit mode.
- **Constant Transmission during Call:**

As soon as communication is established, the target transceiver enters the transmit mode.

The No Voice Release Timer detects only the signal (VOX or RTP) received from the Converter Bridge connection destination.

① When “Constant Transmission during Call” is selected, the No Voice Release Timer detects the communication status only by the received signal from the specified destination.

(PBX Extension > Transceiver Controller Telephone Connection > Release Timer)

If a signal from the specified destination is not received for the set period of time, the call may be terminated because of the No Voice Release Timer function.

#### 13 PTT-ON Tone .....

Select the PTT-ON tone when the either the signal types shown above (12) is set to “DTMF.” (Default: 0)

- Range: 0 ~ 9, \*, or #

① Dial this number on the SIP phone to make a destination device start transmitting.

① If you enter the same value to both the PTT-ON Tone and the PTT-OFF Tone, you can toggle the destination device status by dialing this number.

## Converter Bridge screen

### PBX Extension > Converter Bridge

#### ■ Control

Control	
PTT Control Type	PTT Control Type: 12 DTMF
	PTT-ON Tone: 13 0
	PTT-OFF Tone: 14 0
Call Initiation Control	Method: 15 RTP

① “PTT-ON Tone” (13) and “PTT-OFF Tone” (14) are displayed only when “PTT Control Type” (12) is set to “DTMF.”

#### 14 PTT-OFF Tone .....

Select the PTT-OFF tone when the PTT Control Tone (12) is set to “DTMF.” (Default: 0)

- Range: 0 ~ 9, \*, or #
- ① Dial this tone on the SIP phone to make the destination device stop transmitting.
- ① If you enter the same value to both the PTT-ON Tone and PTT-OFF Tone, you can toggle the destination device status by dialing this number.

#### 15 Method .....

Set the transmitting trigger to make a call from a bridge to the IP telephone system. (Default: RTP)

- **VOX:** Starts dialing when the VOX detects voice data in the voice packet that is received by the bridge interface through RTP (Real-time Transport Protocol).
- **RTP:** Starts dialing when RTP (voice data packet) is received later than the set period time in the Attack Time setting, regardless of if the RTP includes voice data or not.

## Converter Bridge screen

PBX Extension > Converter Bridge

### DTMF Dialing

Set details on DTMF Dialing through a Converter Bridge connection port.

**DTMF Dialing**

---

DTMF Dialing: ①  Disable  Enable

Timer

Permissible Tone Gap: ② 5 ▼

OFF-hook Detect Timer: ③ 400 ▼ milliseconds  
\*Applied only if the OFF-hook settings in [Special Number] are set to values with one digit.

ON-hook Detect Timer: ④ 400 ▼ milliseconds  
\*Applied only if the ON-hook setting in [Special Number] is set to a value with one digit.

① The screen above shows when “DTMF Dialing” (①) is set to “Enable.”

- ① **DTMF Dialing** ..... Select “Enable” to use DTMF signaling.  
If enabled, set the details in the timer. (Default: Disable)
  
- ② **Permissible Tone Gap** ..... Set the period of time to detect that the last digit has been input. (Default: 5)
  - Range: 1 ~ 10 (seconds)
  - ① Applied only when a 1 digit number is set to the OFF-hook settings in the Special Number screen.
  
- ③ **OFF-hook Detect Timer** ... Set the period of time to detect the ON-hook control signal. (Default: 400)
  - Range: 0 ~ 2000 (milliseconds)
  - ① Applied only when a 1 digit number is set to the OFF-hook settings in the Special Number screen.
  
- ④ **ON-hook Detect Timer** ..... Select the period of time to detect the ON-hook control signal. (Default: 400)
  - Range: 0 ~ 2000 (milliseconds)

## Converter Bridge screen

PBX Extension > Converter Bridge

### ■ PTT Control Setting

The VOX (voice operated transmission) function automatically switches the connected transceiver to transmit, when the RoIP gateway receives an audio signal to the Converter Bridge connection destination device.

PTT Control Setting		
*Setting values of Attack Time, Release Time and Voice Delay are set in five milliseconds steps.		
Attack Time :	① 50	milliseconds
Release Time :	② 500	milliseconds
Voice Delay :	③ 200	milliseconds
VOX Threshold :	④ 40	%

- ① Attack Time** ..... Enter the TX delay time. (Default: 50)

  - Range: 5 ~ 500 (milliseconds) in 5 millisecond steps
  - After the continuous signal for the set period of time is received from a SIP phone, the transceiver controller starts to transmit.
  
- ② Release Time** ..... Select the RX delay time. (Default: 500)

  - Range: 5 ~ 2000 (milliseconds) in 5 millisecond steps
  - This is the delay time for the VOX to turn OFF, after no audio signal is received through the network.
  
- ③ Voice Delay** ..... Set the audio signal buffer time to prevent intermittent audio. (Default: 200)

  - Range: 0 ~ 500 (milliseconds) in 5 millisecond steps
  - The voice delay is the amount of time the RoIP gateway stores the transmitted audio to prevent missing the first part of the speech.
  
- ④ VOX Threshold** ..... Set the voice threshold level. (Default: 40)

  - Range: 0 ~ 100 (%)
  - The VOX function automatically switches between receive and transmit according to this threshold level. The lower values make the VOX function more sensitive to the voice input.

## Converter Bridge screen

PBX Extension > Converter Bridge

### ■ Call Initiation Setting

The VOX (voice operated transmission) function automatically switches the connected transceiver to receive, when the RoIP gateway receives the audio signal from the bridge connection destination device.

Call Initiation Setting	
*Setting values of Attack Time, Release Time and Voice Delay are set in five milliseconds steps.	
Attack Time : ①	1000 milliseconds
Release Time : ②	200 milliseconds
Voice Delay : ③	5 milliseconds
VOX Threshold : ④	70 %

- ① Attack Time** ..... Enter the TX attack time. It is the delay time before the VOX switch turns ON after an audio signal is received through the network. (Default: 1000)

  - Range: 5 ~ 2000 (milliseconds) in 5 millisecond steps
  
- ② Release Time** ..... Select the RX delay time in 5 millisecond step. It is the delay time for the VOX switch to turn OFF after no audio signal is received through the network. (Default: 200)

  - Range: 5 to 2000 (milliseconds) in 5 millisecond steps
  
- ③ Voice Delay** ..... Set the audio signal buffer time to prevent intermittent audio. (Default: 5)

  - Range: 0 ~ 500 (milliseconds) in 5 millisecond steps
  
- ④ VOX Threshold** ..... Set the voice threshold level. The audio signal is output to the network according to this threshold level. (Default: 70)

  - Range: 0 ~ 100 (%)
  - ① The lower values make the VOX function more sensitive to the voice input.



## Converter Bridge screen

PBX Extension > Converter Bridge

### ■ Notice Tone on the Telephone

Sets the details on the notification to SIP phones when a call has arrived on a Converter Bridge port of the RoIP gateway.

Notice Tone on the Telephone		
Connection Success :	① Notice Tone 1	▼
PTT Monitoring :	② Not used	▼
Notice Tone Volume :	③ 0	▼ dB

- ① Connection Success** ..... Select a Notice Tone to notify a SIP phone that a call has arrived on the transceiver controller, and the SIP phone is ready to transmit. (Default: Notice Tone 1)

  - **Not used:** Does not send a Notice Tone
  - **Notice Tone 1 ~ 3:** Sends the selected Notice Tone
  
- ② PTT Monitoring** ..... Select a Notice Tone to alert you to switch receiving and transmitting. (Default: Not used)

  - **Not used:** Does not send a Notice Tone
  - **Notice Tone 1 ~ 3:** Sends the selected Notice Tone
  
- ③ Notice Tone Volume** ..... Set the volume level of the Notice Tones (① ~ ②). (Default: 0)

  - Range: -12 (minimum) ~ +6 (maximum) (dB)

## Converter Bridge screen

PBX Extension > Converter Bridge

### ■ Release Timer

Sets the timers for canceling or disconnecting a call.

**Release Timer**

Call Cancel Timer :	15	seconds
No Voice Release Timer :	15	seconds
<b>Forced Disconnect</b>		
Forced Disconnect Timer :	10	minutes

Apply    Reset

- 1 Call Cancel Timer** ..... Enter the period of time to cancel the call. When the set time has passed without a response from the SIP phone, the call is canceled. (Default: 15)

  - Range: 0 (OFF) or 5 ~ 60 (seconds)
  
- 2 No Voice Release Timer** ... Enter the period of time to stop transmitting. When the set time has passed with no audio signal, transmitting is stopped. (Default: 15)

  - Range: 0 (OFF) or 5 ~ 600 (seconds)
  
- 3 Forced Disconnect Timer** Enter the period of time to be forcibly stop transmitting. When the set time has passed, transmitting is stopped, even when the communication is ongoing. (Default: 10)

  - Range: 0 (OFF) or 5 ~ 120 (minutes)
  
- 4 <Apply>** ..... Click to apply the setting.
  
- 5 <Reset>** ..... Click to reset the setting.  
 ⓘ You cannot reset after clicking <Apply>.

---

Advanced Settings screen .....	14-2
■ SIP Settings .....	14-2
■ VoIP Settings .....	14-4
Prioritization screen .....	14-11
■ EXT Output Port Prioritization .....	14-11
■ Caller Prioritization .....	14-12
■ List of Caller Prioritization Entries.....	14-14
Numbering Plan screen .....	14-15
■ Phone Number Routing Settings .....	14-15
■ List of Phone Number Routing Settings .....	14-16
■ Exception Outbound Phone Number .....	14-17
■ Outbound Phone Number Reformatting Settings .....	14-18
■ List of Outbound Phone Number Reformatting Settings .....	14-19
■ Outbound Call Restriction Rule Settings .....	14-20
■ List of Outbound Call Restriction Rule Settings .....	14-21
Outside Line Regulation screen.....	14-22
■ Outside Line Regulation.....	14-22
External Call Limiting screen .....	14-23
■ Overall Limitation.....	14-23
■ Limitation for each Outside Line .....	14-24
IP Authenticated Extension screen .....	14-25
■ IP Authenticated Extension (Pre-registered Extension) .....	14-25
■ List of IP Authenticated Extension .....	14-26
Caller Number Reformatting screen .....	14-27
■ Source Line Settings .....	14-27
■ Caller Number Reformatting Settings .....	14-28
■ List of Caller Number Reformatting Settings .....	14-29
DID screen.....	14-30
■ DID Allocation .....	14-30
■ DID Settings.....	14-31
■ List of DID settings .....	14-32

## Advanced Settings screen

PBX Advanced Settings > Advanced Settings

### SIP Settings

The common settings for the terminals to the RoIP gateway.

**SIP Settings**

Extension Domain : ①  LAN IP address  Specify  
 Domain : \_\_\_\_\_

SIP 183 Support : ②  Disable  Enable

Relay SIP Response : ③  Disable  Enable

Relay Internal Response : ④  Disable  Enable

Caller ID Relay on Call Forwarding : ⑤  Not relay  Relay

Preferred Inbound Call Setting : ⑥  IP Line  Peer to Peer

Use Letters for Phone Number : ⑦  Inhibit  Allow

- ① Extension Domain .....** You can enter a SIP service domain name of up to 63 characters, to commonly use between the local SIP server and its client SIP phones. (Default: LAN IP address)

  - ① Enter a unique Extension Domain in an IP telephone network. The IP address of the RoIP gateway is recommended for your Extension Domain name to prevent a conflict in domain names.
  - ① Enter this value in the “SIP service domain” setting in the client telephone settings.
  
- ② SIP 183 Support .....** Enable this option if you want to use the 183 Session Progress. (Default: Disable)

The 183 Session Progress response indicates that information about the call state is present in the message body media information (SDP).

  - ① When this option is enabled, the 183 session progress is transferred to a client SIP phone.
  
- ③ Relay SIP Response .....** Set whether or not to relay an error message received from an upstream SIP server when a call is outgoing. (Default: Enable)

  - **Enable:** Relays an error response (4xx ~ 6xx) from the SIP server.
  - **Disable:** Translates an error response (4xx ~ 6xx) into a 486 response and relays it.
  - ① Enable this setting if you want to use a slide outgoing function by connecting another SIP server to this RoIP gateway as a simple relay client device.

## Advanced Settings screen

### PBX Advanced Settings > Advanced Settings

#### ■ SIP Settings

**SIP Settings**  
Extension Domain : ①  LAN IP address  Specify  
Domain : \_\_\_\_\_  
SIP 183 Support : ②  Disable  Enable  
Relay SIP Response : ③  Disable  Enable  
Relay Internal Response : ④  Disable  Enable  
Caller ID Relay on Call Forwarding : ⑤  Not relay  Relay  
Preferred Inbound Call Setting : ⑥  IP Line  Peer to Peer  
Use Letters for Phone Number : ⑦  Inhibit  Allow

- ④ **Relay Internal Response ...** Set whether or not to relay an error message received from a client SIP phone, when a call is incoming. (Default: Disable)  
• **Enable:** Relays an error response (4xx ~ 6xx) from the SIP phone.  
• **Disable:** Translates an error response (4xx ~ 6xx) into a 486 response and relays it.
- ⑤ **Caller ID Relay on Call Forwarding .....** Set whether or not to relay the original caller number of a forwarded call by using the Blind Transfer function. (Default: Relay)  
• **Not relay:** Your number is shown at the forwarded destination.  
• **Relay:** The original caller number is shown at the forwarded destination.
- ⑥ **Preferred Inbound Call Setting .....** Set which line to consider when the SIP URI of an incoming call over the IP line conflicts with the SIP URI of a Peer to Peer line. (Default: IP Line)
- ⑦ **Use Letters for Phone Number .....** If allowed, you can enter letters as a phone number. (Default: Inhibit)

## Advanced Settings screen

PBX Advanced Settings > Advanced Settings

### VoIP Settings

Sets the audio quality for SIP phones. The setting items vary, depending on the TOS Type.

#### TOS Type: Not Used

**VoIP Settings**

Buffering Type: ①  Static  Dynamic

Receive Buffer Size: ② 40 ▼ milliseconds

TOS Type: ③ Not Used ▼

⑥ Apply ⑦ Reset

#### TOS Type: TOS

**VoIP Settings**

Buffering Type: ①  Static  Dynamic

Receive Buffer Size: ② 40 ▼ milliseconds

TOS Type: ③ TOS ▼

Media (RTP) Priority Level: ④ 7

Media (RTP) Service Type: 0

Media (RTP) (HEX): E0

Signaling (SIP) Priority Level: ⑤ 6

Signaling (SIP) Service Type: 0

Signaling (SIP) (HEX): C0

⑥ Apply ⑦ Reset

#### TOS Type: Diffserv

**VoIP Settings**

Buffering Type: ①  Static  Dynamic

Receive Buffer Size: ② 40 ▼ milliseconds

TOS Type: ③ Diffserv ▼

Media (RTP) DSCP: ④ 56

Media (RTP) (HEX): E0

Signaling (SIP) DSCP: ⑤ 48

Signaling (SIP) (HEX): C0

⑥ Apply ⑦ Reset

① The screens above show when the Buffering Type (①) is set to "Static"

#### ① Buffering Type .....

Select the jitter buffer used to reduce speech break up due to packet fluctuations. (Default: Dynamic)

- **Static:** Buffers receive voice data for a set period of time in the Receive Buffer Size (②).
- **Dynamic:** Buffering time of the received voice data varies, according to the packet fluctuation status.

## Advanced Settings screen

### PBX Advanced Settings > Advanced Settings

#### VoIP Settings

##### TOS Type: Not Used

**VoIP Settings**

Buffering Type: ①  Static  Dynamic

Receive Buffer Size: ② 40 ▼ milliseconds

TOS Type: ③ Not Used ⑥ ⑦

Apply Reset

##### TOS Type: TOS

**VoIP Settings**

Buffering Type: ①  Static  Dynamic

Receive Buffer Size: ② 40 ▼ milliseconds

TOS Type: ③ TOS ▼

Media (RTP) Priority Level: ④ 7

Media (RTP) Service Type: 0

Media (RTP) (HEX): E0

Signaling (SIP) Priority Level: ⑤ 6

Signaling (SIP) Service Type: 0

Signaling (SIP) (HEX): C0 ⑥ ⑦

Apply Reset

##### TOS Type: Diffserv

**VoIP Settings**

Buffering Type: ①  Static  Dynamic

Receive Buffer Size: ② 40 ▼ milliseconds

TOS Type: ③ Diffserv ▼

Media (RTP) DSCP: ④ 56

Media (RTP) (HEX): E0

Signaling (SIP) DSCP: ⑤ 48

Signaling (SIP) (HEX): C0 ⑥ ⑦

Apply Reset

① The screens above show when the Buffering Type (①) is set to “Static”

#### ② Receive Buffer Size .....

Displayed only when Buffering Type (①) is set to “Static.”  
Set the period of time to buffer the received voice data. (Default: 40)

• Range: 20 ~ 1000 (milliseconds)

① The shorter the time you set, the less the delay, however the more the sound will be interrupted.

## Advanced Settings screen

### PBX Advanced Settings > Advanced Settings

#### VoIP Settings

##### TOS Type: Not Used

**VoIP Settings**

Buffering Type: ①  Static  Dynamic

Receive Buffer Size: ② 40 ▼ milliseconds

TOS Type: ③ Not Used ⑥ ⑦

Apply Reset

##### TOS Type: TOS

**VoIP Settings**

Buffering Type: ①  Static  Dynamic

Receive Buffer Size: ② 40 ▼ milliseconds

TOS Type: ③ TOS ▼

Media (RTP) Priority Level: ④ 7

Media (RTP) Service Type: 0

Media (RTP) (HEX): E0

Signaling (SIP) Priority Level: ⑤ 6

Signaling (SIP) Service Type: 0

Signaling (SIP) (HEX): C0 ⑥ ⑦

Apply Reset

##### TOS Type: Diffserv

**VoIP Settings**

Buffering Type: ①  Static  Dynamic

Receive Buffer Size: ② 40 ▼ milliseconds

TOS Type: ③ Diffserv ▼

Media (RTP) DSCP: ④ 56

Media (RTP) (HEX): E0

Signaling (SIP) DSCP: ⑤ 48

Signaling (SIP) (HEX): C0 ⑥ ⑦

Apply Reset

① The screens above show when the Buffering Type (①) is set to "Static"

#### ③ TOS Type .....

Set TOS Type.

(Default: TOS)

- **Not Used:** Does not use the TOS function.
- **TOS:** Outputs the VoIP packet to the TOS field (8 bit) in the IP header, in the TOS (Type Of Service) format.

① TOS format applies RFC1349.

- The first 3 bits: Shows the priority.  
Set into "Media (RTP) Priority Level" (④) with a decimal number.
- The next 4 bits: Shows the service type.  
Set into "Media (RTP) Service Type" (④) with a decimal number.  
The larger number, the higher priority.
- The last 1 bits: Reserved and fixed to "0."



## Advanced Settings screen

### PBX Advanced Settings > Advanced Settings

#### VoIP Settings

##### TOS Type: Not Used

**VoIP Settings**

Buffering Type : ①  Static  Dynamic

Receive Buffer Size : ② 40 ▼ milliseconds

TOS Type : ③ Not Used ⑥ ⑦▼

Apply Reset

##### TOS Type: TOS

**VoIP Settings**

Buffering Type : ①  Static  Dynamic

Receive Buffer Size : ② 40 ▼ milliseconds

TOS Type : ③ TOS ▼

Media (RTP) Priority Level : ④ 7

Media (RTP) Service Type : 0

Media (RTP) (HEX) : E0

Signaling (SIP) Priority Level : ⑤ 6

Signaling (SIP) Service Type : 0

Signaling (SIP) (HEX) : C0

⑥ ⑦

Apply Reset

##### TOS Type: Diffserv

**VoIP Settings**

Buffering Type : ①  Static  Dynamic

Receive Buffer Size : ② 40 ▼ milliseconds

TOS Type : ③ Diffserv ▼

Media (RTP) DSCP : ④ 56

Media (RTP) (HEX) : E0

Signaling (SIP) DSCP : ⑤ 48

Signaling (SIP) (HEX) : C0

⑥ ⑦

Apply Reset

① The screens above show when the Buffering Type (①) is set to “Static”

#### ③ TOS Type (Continued) .....

**Diffserv:** Outputs the VoIP packet to the TOS field (8 bit) in the IP header, in the Diffserv (Differentiated Service) format.

① The Diffserv format details:

- The former 6 bits: Shows the DSCP.  
Set “Media (RTP) DSCP” (④) with a decimal number.  
The larger number, the higher priority.
- The next 2 bits: Reserved and fixed to “0.”

## Advanced Settings screen

### PBX Advanced Settings > Advanced Settings

#### VoIP Settings

##### TOS Type: Not Used

**VoIP Settings**

Buffering Type : 1  Static  Dynamic

Receive Buffer Size : 2 40 ▼ milliseconds

TOS Type : 3 Not Used 6 7 ▼

Apply Reset

##### TOS Type: TOS

**VoIP Settings**

Buffering Type : 1  Static  Dynamic

Receive Buffer Size : 2 40 ▼ milliseconds

TOS Type : 3 TOS ▼

Media (RTP) Priority Level : 4 7

Media (RTP) Service Type : 0

Media (RTP) (HEX) : E0

Signaling (SIP) Priority Level : 5 6

Signaling (SIP) Service Type : 0

Signaling (SIP) (HEX) : C0

6 7

Apply Reset

##### TOS Type: Diffserv

**VoIP Settings**

Buffering Type : 1  Static  Dynamic

Receive Buffer Size : 2 40 ▼ milliseconds

TOS Type : 3 Diffserv ▼

Media (RTP) DSCP : 4 56

Media (RTP) (HEX) : E0

Signaling (SIP) DSCP : 5 48

Signaling (SIP) (HEX) : C0

6 7

Apply Reset

① The screens above show when the Buffering Type (1) is set to "Static"

4 **Media (RTP)** ..... Setting the Priority details for the TOS or Diffserv format options.

- **Priority Level:** Set the value of the priority level for TOS. (Default: 7)  
Range: 0 ~ 7 (in decimal)
- **Service Type:** Set the value of the service type for TOS. (Default: 0)  
Range: 0 ~ 15 (in decimal)
- **DSCP:** Set the value of DSCP (Differentiated Services Code Point) for Diffserv. (Default: 56)  
Range: 0 ~ 63 (in decimal)

## Advanced Settings screen

### PBX Advanced Settings > Advanced Settings

#### VoIP Settings

##### TOS Type: Not Used

**VoIP Settings**

Buffering Type : ①  Static  Dynamic

Receive Buffer Size : ② 40 ▼ milliseconds

TOS Type : ③ Not Used ⑥ ⑦

Apply Reset

##### TOS Type: TOS

**VoIP Settings**

Buffering Type : ①  Static  Dynamic

Receive Buffer Size : ② 40 ▼ milliseconds

TOS Type : ③ TOS ▼

Media (RTP) Priority Level : ④ 7

Media (RTP) Service Type : 0

Media (RTP) (HEX) : E0

Signaling (SIP) Priority Level : ⑤ 6

Signaling (SIP) Service Type : 0

Signaling (SIP) (HEX) : C0 ⑥ ⑦

Apply Reset

##### TOS Type: Diffserv

**VoIP Settings**

Buffering Type : ①  Static  Dynamic

Receive Buffer Size : ② 40 ▼ milliseconds

TOS Type : ③ Diffserv ▼

Media (RTP) DSCP : ④ 56

Media (RTP) (HEX) : E0

Signaling (SIP) DSCP : ⑤ 48

Signaling (SIP) (HEX) : C0 ⑥ ⑦

Apply Reset

① The screens above show when the Buffering Type (①) is set to "Static"

- ⑤ **Signaling (SIP)** ..... Setting the Priority options for VoIP packets that are output to the TOS field.
- **Priority Level:** Set the value of the priority level for TOS. (Default: 6)  
Range: 0 ~ 7 (in decimal)  
The larger number, the higher priority.
  - **Service Type:** Set the value of the service type for TOS. (Default: 0)  
Range: 0 ~ 15 (in decimal)
  - **DSCP:** Set the value of DSCP (Differentiated Services Code Point) for Diffserv. (Default: 48)  
Range: 0 ~ 63 (in decimal)

## Advanced Settings screen

### PBX Advanced Settings > Advanced Settings

#### VoIP Settings

##### TOS Type: Not Used

**VoIP Settings**

Buffering Type: ①  Static  Dynamic

Receive Buffer Size: ② 40 ▼ milliseconds

TOS Type: ③ Not Used ⑥ ⑦

Apply Reset

##### TOS Type: TOS

**VoIP Settings**

Buffering Type: ①  Static  Dynamic

Receive Buffer Size: ② 40 ▼ milliseconds

TOS Type: ③ TOS ▼

Media (RTP) Priority Level: ④ 7

Media (RTP) Service Type: 0

Media (RTP) (HEX): E0

Signaling (SIP) Priority Level: ⑤ 6

Signaling (SIP) Service Type: 0

Signaling (SIP) (HEX): C0

⑥ Apply ⑦ Reset

##### TOS Type: Diffserv

**VoIP Settings**

Buffering Type: ①  Static  Dynamic

Receive Buffer Size: ② 40 ▼ milliseconds

TOS Type: ③ Diffserv ▼

Media (RTP) DSCP: ④ 56

Media (RTP) (HEX): E0

Signaling (SIP) DSCP: ⑤ 48

Signaling (SIP) (HEX): C0

⑥ Apply ⑦ Reset

① The screens above show when the Buffering Type (①) is set to "Static"

⑥ <Apply> ..... Click to apply the setting.

⑦ <Reset> ..... Click to reset the setting.

① You cannot reset after clicking <Apply>.

## Prioritization screen

PBX Advanced Settings > Prioritization

### ■ EXT Output Port Prioritization

Set the priority of incoming calls from SIP phones or external devices.

**EXT Output Port Prioritization**

---

From Other Ports : ① Normal ▼

From Own Input Port : ② Normal ▼

\*This setting is only valid when EXT I/O mode is set to [Separate mode].

3    4

- ① **From Other Ports** ..... Set the priority of Incoming calls arrived at other ports than the EXT/IO (1 ~ 4) ports. (Default: Normal)

  - Options: Normal, Priority, or High Priority
  
- ② **From Own Input Port** ..... Set the priority of Incoming calls from the devices those are connected to the EXT/IO (1 ~ 4) ports on this RoIP Gateway. (Default: Normal)

This setting is only valid when EXT I/O mode is set to "Separate mode."

  - Options: Normal, Priority, or High Priority
  
- ③ **<Apply>** ..... Click to apply the entries.
  
- ④ **<Reset>** ..... Click to reset the entries.

  - ① You cannot reset after clicking <Apply>.

## Prioritization screen

PBX Advanced Settings > Prioritization

### ■ Caller Prioritization

Set the priority of incoming calls from SIP phones or external devices. When a call from the specified SIP phone has arrived while you are talking on another call, the RoIP gateway terminates the current call to catch the arrived call.

The priority of calls from other than the specified SIP phone depends on the Priority level (5)

#### Called via: SIP Server

**Caller Prioritization**

Index : 1

Name :

Called via :  SIP Server  Peer to Peer

Phone Number :

Priority Level : Normal

7 Add 8 Reset

#### Called via: Peer to Peer

**Caller Prioritization**

Index : 2

Name :

Called via :  SIP Server  Peer to Peer

SIP URI : sip :

Priority Level : Normal

7 Add 8 Reset

- 1 **Index** ..... Select a number.  
• Range: 1 ~20
- 2 **Name** ..... Enter a caller's name of up to 31 characters.
- 3 **Called via** ..... Select the line type of an incoming call.  
• **SIP Server**: Through an IP line.  
• **Peer to Peer**: Peer to Peer
- 4 **Phone Number** ..... Displayed when Called via (3) is set to "SIP Server."  
Enter a caller's Phone Number of up to 31 digits.

## Prioritization screen

### PBX Advanced Settings > Prioritization

#### ■ Caller Prioritization

##### Called via: SIP Server

**Caller Prioritization**

Index : ① 1

Name : ②

Called via : ③  SIP Server  Peer to Peer

Phone Number : ④

Priority Level : ⑤ Normal

⑦     ⑧

##### Called via: Peer to Peer

**Caller Prioritization**

Index : ① 2

Name : ②

Called via : ③  SIP Server  Peer to Peer

SIP URI : ⑥ sip : \_\_\_\_\_

Priority Level : ⑤ Normal

⑦     ⑧

- ⑤ **Priority Level** ..... Set the priority of the destination. (Default: Normal)
  - Options: Normal, Priority, or High Priority
  - ① When a call from the prior IP phone has been arrived while you are talking on another call, the current call is terminated and a Ring Tone will ring to alert you a prior call is incoming.
  - When a call from the same priority as the current call, the current request will stay connected.
  - ① An emergency call has priority over all other calls.
  
- ⑥ **SIP URI** ..... Displayed when Called via (③) is set to "Peer to Peer."  
Enter the caller's SIP URI of up to 63 characters.
  
- ⑦ **<Add>** ..... Click to add the entries.
  
- ⑧ **<Reset>** ..... Click to reset the entries.
  - ① You cannot reset after clicking <Apply>.

## Prioritization screen

PBX Advanced Settings > Prioritization

### ■ List of Caller Prioritization Entries

The list of the entries into the Caller Prioritization.

Index	Name	Phone Number / SIP URI	Priority Level	1	2
1	Sales John Smith	010123456789	Normal	Edit	Delete

3  
Delete All

- 1 <Edit> ..... Click to edit an entry.
- 2 <Delete> ..... Click to delete an entry.
- 3 <Delete All> ..... Click to delete all the entries.  
① You cannot restore after clicking <Delete All>.



## Numbering Plan screen

PBX Advanced Settings > Numbering Plan

### Phone Number Routing Settings

Set the Routing rules.

Phone Number Routing Settings				
Index <sup>1</sup>	Prefix <sup>2</sup>	Outbound Phone Number <sup>3</sup>	Outbound IP Line <sup>4</sup>	<sup>5</sup>
1				Add

- 1 Index** ..... Enter an index number of the Routing rule up to 400 entries.
- 2 Prefix** ..... Enter a Prefix of the phone number of up to 7 digits. The entered prefix will be deleted when the RoIP gateway dials outbound using the Outbound IP Line (4).  
 ⓘ You can also set the prefix of the phone number in the “External Call Routing Number” (PBX > Special Number > External Call Routing Number)
- 3 Outbound Phone Number** ..... Enter the specified phone number of up to 15 digits. When a phone number that starts with the specified number is dialed, the RoIP gateway will call outbound using the Outbound IP Line (4).
- 4 Outbound IP Line** ..... Select from the phone numbers that are entered in the “IP Line” screen.
- 5 <Add>** ..... Click to add the entry.

## Numbering Plan screen

PBX Advanced Settings > Numbering Plan

### ■ List of Phone Number Routing Settings

Displays the list of entries into the Phone Number Routing Settings.

Index	Prefix	Outbound Phone Number	Outbound IP Line	1	2
1		800	1234567890	Edit	Delete

3  
Delete All

- 1 <Edit> ..... Click to edit an entry.
- 2 <Delete> ..... Click to delete an entry.
- 3 <Delete All> ..... Click to delete all the entries.  
① You cannot restore after clicking <Delete All>.

## Numbering Plan screen

PBX Advanced Settings > Numbering Plan

### ■ Exception Outbound Phone Number

Enter external phone numbers to exclude from applying Outbound Call Restriction Rule or Phone Number Reformatting rule.

**Exception Outbound Phone Number**

Outbound Phone Numbers the **1** following rules are not applied :

**2** Apply **3** Reset

#### **1 Outbound Phone Numbers the following rules are not applied**

Enter up to 5 special numbers. When an external phone number, that starts with either of these numbers, is dialed, the digits of the special number are excluded from applying the Outbound Call Restriction Rule or Phone Number Reformatting rule.

**2 <Apply>** ..... Click to apply the entries.

**3 <Reset>** ..... Click to reset the settings.  
ⓘ You cannot reset after clicking <Apply>.

## Numbering Plan screen

PBX Advanced Settings > Numbering Plan

### ■ Outbound Phone Number Reformatting Settings

Enter external phone numbers that apply or do not apply the phone number reformatting rules. The Reformatting rules are applied only for outbound calls.

Outbound Phone Number Reformatting Settings					
Index <sup>1</sup>	Reformat <sup>2</sup>	Outbound Phone Number <sup>3</sup>	Delete Digits <sup>4</sup>	Added Number <sup>5</sup>	<sup>6</sup>
1	Apply		Don't delete		Add

- 1 Index** ..... Enter the order for Number Reformatting operation.  
 • Range: 1 ~ 100
- 2 Reformat** ..... Set whether or not to reformat the dialed number if a matched number is dialed. (Default: Apply)  
 • **Apply:** Reformats the number according to the rule.  
 • **Exception:** Does not reformat the number.  
 ⓘ The “Exception” rules has priority over the “Apply” rules.
- 3 Outbound Phone Number** Enter the beginning of a outbound phone number of up to 15 digits. When an outbound phone number that starts with the specified number is dialed, the RoIP gateway applies the Number Reformatting. (Default: Blank)
- 4 Delete Digits** ..... Enter a number of digits if you want to delete specified digits at the beginning of the dialed number. (Default: Don't delete)  
 • Range: Don't delete, or 1 ~ 15
- 5 Added Number** ..... Enter a number that you want to add at the beginning of the dialed number of up to 15 digits. (Default: Blank)
- 6 <Add>** ..... Click to add the entries.

#### Number Reformatting examples:

##### ○ Example 1

- Outbound Phone Number (3): 987
- Delete Digits (4) : Don't Delete
- Added Number (5) : 800

Dialed number: 98765432



Reformatted to: 80098765432

##### ○ Example 2

- Outbound Phone Number (3):0006
- Delete Digits (4) : 3
- Added Number (5) : 800987

Dialed number: 00065432



Reformatted to: 80098765432

## Numbering Plan screen

PBX Advanced Settings > Numbering Plan

### ■ List of Outbound Phone Number Reformatting Settings

The list of entered rules into Outbound Phone Number Reformatting Settings.

Index	Reformat	Outbound Phone Number	Delete Digits	Added Number	1	2
1	Apply	987	Don't delete	800	Edit	Delete
2	Exception	0800			Edit	Delete
3	Apply	080	3	090	Edit	Delete
4	Apply	0006	3	800987	Edit	Delete

3  
Delete All

- 1 <Edit> ..... Click to edit an entry.
- 2 <Delete> ..... Click to delete an entry.
- 3 <Delete All> ..... Click to delete all the entries.  
ⓘ You cannot restore after clicking <Delete All>.

## Numbering Plan screen

PBX Advanced Settings > Numbering Plan

### ■ Outbound Call Restriction Rule Settings

Enter destination phone numbers to restrict or to apply to call.

**Outbound Call Restriction Rule Settings**

Rule Index : ① 1 ▼

Restricted Phone Numbers : ② Starting with

010			

Exceptions to the Restricted Phone Numbers : ③ Starting with

011			

- ① **Rule Index** ..... You can set restriction rules to each Extension Group (PBX > Extension Group.)  
 Select a group to apply the restriction rules. (Default: Common)

  - **Common**: Applies all the groups.
  - **1 ~ 16**: Applies individual groups.

Click <Add> to add the entered rule to the List of Extension Group Entries.
- ② **Restricted Phone Numbers** Enter external phone numbers of up to 15 digits to restrict to outbound calls when the dialed number matches them. (Default: Blank)  
 You can enter up to 20 numbers to each Rule Index (①).
- ③ **Exceptions to the Restricted Phone Numbers** Enter external phone numbers of up to 15 digits to apply to outbound calls when the dialed number matches them. (Default: Blank)  
 You can enter up to 20 numbers to each Rule Index (①).

## Numbering Plan screen

PBX Advanced Settings > Numbering Plan

### ■ List of Outbound Call Restriction Rule Settings

The list of entered rules into Outbound Call Restriction Rule Settings.

Rule Index	Outbound Phone Number			
	Restricted	Exception	1	2
Common	0	01	Edit	Delete
1	123 550		Edit	Delete

3  
Delete All

- 1 <Edit> ..... Click to edit an entry.
- 2 <Delete> ..... Click to delete an entry.
- 3 <Delete All> ..... Click to delete all the entries.  
① You cannot restore after clicking <Delete All>.

## Outside Line Regulation screen

PBX Advanced Settings > Outside Line Regulation

### ■ Outside Line Regulation

Set the External line. The outbound call management rules can be applied to this setting.

Outside Line Regulation			
Outside Line Phone Number	Line	Call Restriction <sup>1</sup>	Number Reformatting <sup>2</sup>
100	IP Line	Disable	Disable

- 1 Call Restriction** ..... Restricts outbound calls for the selected phone line (number). (Default: Disable)

  - **Disable:** Does not restrict outbound calls.
  - **Call Restriction Rule 1 ~ 16:** Restricts outbound calls according to the selected rule that is set in "Outbound Call Restriction Rule Settings" in addition to the "Call Restriction" setting in the "Telephone Common Settings".
  - **External Call Restriction:** Restricts outbound calls, excluding Peer to Peer calls.
  
- 2 Number Reformatting** ..... Set whether or not to reformat dialed number. (Default: Disable)  
 If enabled, dialed external numbers are reformatted, according to the rules set in "Outbound Phone Number Reformatting Settings." (PBX Advanced Settings > Numbering Plan > List of Outbound Phone Number Reformatting Settings)
  
- 3 <Apply>** ..... Click to apply the entries.
  
- 4 <Reset>** ..... Click to reset the settings.  
 ⓘ You cannot reset after clicking <Apply>.



## External Call Limiting screen

PBX Advanced Settings > External Call Limiting

### Overall Limitation

Set the limit number of the usable outside lines (phone numbers) simultaneously, according to the whole lines connected to the RoIP gateway.

Overall Limitation	
Maximum Number of Simultaneous calls on the whole Outside Lines : ①	50
Maximum Number of Simultaneous calls on the Priority Outside Lines : ②	0
Simultaneous Ringing Restriction : ③	<input type="radio"/> Disable <input checked="" type="radio"/> Enable

#### ① Maximum Number of Simultaneous calls on the whole Outside Lines

Set the maximum number of external lines that can simultaneously make. If more calls are inbound or outbound than the value of this setting, they will be busy. (Default: 50)  
• Range: 1 ~ 50

#### ② Maximum Number of Simultaneous calls on the Priority Outside Lines

Set the maximum number of lines to reserved for priority calls. (Default: 0)  
• Range: 0 ~ 50  
① The number of Normal Outside Lines (non-priority lines) is the value obtained by subtracting the number of Priority Outside Line from the total number of external lines.

#### ③ Simultaneous Ringing Restriction .....

Leave as default for the normal use.  
You can temporarily restrict incoming calls when there is a concentration of incoming calls. (Default: Enable)

## External Call Limiting screen

PBX Advanced Settings > External Call Limiting

### ■ Limitation for each Outside Line

Set the limitation and prioritization settings for each outside line (phone number).

Limitation for each Outside Line			
Outside Line Phone Number <sup>1</sup>	Line <sup>2</sup>	Multiple Call Limitation <sup>3</sup>	Prioritization <sup>4</sup>
100	IP Line	No limit	Normal Outside Line
			<input type="button" value="Apply"/> <input type="button" value="Reset"/>

- 1 Outside Line Phone Number**      Displays the phone numbers in “List of SIP Server Entries.”
- 2 Line** .....      Displays the type of phone line.
- 3 Multiple Call Limitation** ...      Sets the maximum number of calls you can simultaneously make on the phone line. (Default: No limit)  
 • Range: No limit, or 1 ~ 50
- 4 Prioritization** .....      Select the Prioritization of the line. Priority Outside Line means reserved for priority calls. (Default: Normal Outside Line)  
 ① The number of Normal Outside Lines (non-priority lines) is the value obtained by subtracting the number of Priority Outside Line from the total number of external phone lines.
- 5 <Apply>** .....      Click to apply the entries.
- 6 <Reset>** .....      Click to reset the settings.  
 ① You cannot reset after clicking <Apply>.

## IP Authenticated Extension screen

PBX Advanced Settings > IP Authenticated Extension

### ■ IP Authenticated Extension (Pre-registered Extension)

Setting for the gateway connection of the RoIP gateway.

① This settings are for only the special system environment. Leave as default for the normal use.

**IP Authenticated Extension (Pre-registered Extension)**

Extension Number : ① 33(Sales 03) ▼

Activation Status : ② Inactive ▼

Accept Multiple SIP Clients : ③ Disable ▼

SIP Client Identifier : ④ SIP URI ▼

Use Domain to Call the SIP Client : ⑤ OFF ▼

SIP Client Authenticated IP Address : ⑥ \_\_\_\_\_

SIP Domain : ⑦ \_\_\_\_\_

⑧ Apply
⑨ Reset

- ① **Extension Number** ..... Select an Extension number to use the gateway connection.
- ② **Activation Status** ..... Enables the Gateway Connection function of the RoIP gateway.  
If enabled, an extension can communicate without registering to the RoIP gateway under the special condition. (Default: Inactive)
- ③ **Accept Multiple SIP Clients** ..... Enables to use the multiple gateway connections. (Default: Disable)
- ④ **SIP Client Identifier** ..... Select how to identify the SIP Client. (Default: SIP URI)  
• Options: SIP URI or Display Name
- ⑤ **Use Domain to Call the SIP Client** ..... Set whether or not to use a specified domain to make a call through the gateway connection. (Default: OFF)  
When using the IP address of this RoIP gateway, set this item to "OFF."
- ⑥ **SIP Client Authenticated IP Address** ..... Enter the IP address of the target device when you use the gateway connections.
- ⑦ **SIP Domain** ..... Enter the domain name of up to 63 characters or the IP address of the target device, that are used to authenticate the caller through the gateway connection.
- ⑧ **<Apply>** ..... Click to apply the entries.
- ⑨ **<Reset>** ..... Click to reset the settings.  
① You cannot reset after clicking <Apply>.

## IP Authenticated Extension screen

PBX Advanced Settings > IP Authenticated Extension

### ■ List of IP Authenticated Extension

The list of entered IP Authenticated Extension.

Index	Name	Extension Number	IP Authenticated Extension	SIP Client Authenticated IP Address	SIP Domain
1	Sales 01	31	Enable	192.168.1.1	192.168.1.1
2	Sales 02	32	Enable	192.168.1.1	192.168.1.1
3	Sales 03	33	Disable		
4	Sales 04	34	Disable		

- Select an Extension Number in the “IP Authenticated Extension (Pre-registered Extension)” to edit the entry.

## Caller Number Reformatting screen

PBX Advanced Settings > Caller Number Reformatting

### ■ Source Line Settings

Set the rules to reformatting Caller IDs of incoming call.

Line	Phone Number	Reformatting <sup>1</sup>
IP Line	100	Disabled <input type="checkbox"/>
Peer to Peer	VEPG4	Disabled <input type="checkbox"/>
Extension	-	Disabled <input type="checkbox"/>

- 1 Reformatting** ..... Set whether or not to reformat for each Caller Number.  
(Default: Disabled)

① The “Extension” rule is applied for incoming call from extensions that are registered to the same SIP server (VE-PG4).
- 2 <Apply>** ..... Click to apply the entries.
- 3 <Reset>** ..... Click to reset the settings.  
 ① You cannot reset after clicking <Apply>.

## Caller Number Reformatting screen

PBX Advanced Settings > Caller Number Reformatting

### ■ Caller Number Reformatting Settings

Set the Caller IDs that are applied the reformatting rules.

Index <sup>1</sup>	Reformat <sup>2</sup>	Phone Number <sup>3</sup>	Delete Digits <sup>4</sup>	Added Number <sup>5</sup>	<sup>6</sup>
5	Apply		Don't delete		Add

- 1 Index** ..... Enter the order for the Caller Number Reformatting operation.  
 • Range: 1 ~ 100
- 2 Reformat** ..... Set the whether or not to reformat the Caller Number if a matched number is received. (Default: Apply)  
 • **Apply:** Reformats the number according to the rule.  
 • **Exception:** Does not reformat the number.  
 ① The "Exception" rules are prior to the "Apply" rules.
- 3 Phone Number** ..... Enter the number of up to 15 digits. (Default: Blank)  
 When the entered number matches at the beginning of the Caller Number, the reformatting rule is applied.
- 4 Delete Digits** ..... Enter a number of digits if you want to delete specified digits at the beginning of the Caller Number. (Default: Don't delete)  
 • Range: Don't delete, or 1 ~ 15
- 5 Added Number** ..... Enter a number if you want to add up to 15 digits to the beginning of the Caller Number. (Default: Blank)
- 6 <Add>** ..... Click to add the entries.

#### Number Reformatting examples:

**○ Example 1**

- Phone Number (3): 987
- Delete Digits (4): Don't Delete
- Added Number (5): 800

Caller Number: 98765432



Reformatted to: 80098765432

**○ Example 2**

- Phone Number (3): 0006
- Delete Digits (4): 3
- Added Number (5): 800987

Caller Number: 00065432



Reformatted to: 80098765432

## Caller Number Reformatting screen

PBX Advanced Settings > Caller Number Reformatting

### ■ List of Caller Number Reformatting Settings

The list of entered Caller Number Reformatting Settings.

Index	Reformat	Phone Number	Delete Digits	Added Number	1	2
1	Apply	987	Don't delete	800	Edit	Delete
2	Exception	0800			Edit	Delete
3	Apply	080	3	090	Edit	Delete
4	Apply	4567	4	1234	Edit	Delete

3  
Delete All

- 1 <Edit> ..... Click to edit an entry.
- 2 <Delete> ..... Click to delete an entry.
- 3 <Delete All> ..... Click to delete all the entries.  
 ⓘ You cannot restore after clicking <Delete All>.

## DID screen

PBX Advanced Settings > DID

### ■ DID Allocation

**DID Allocation**

100(IP)	Don't Select
---------	--------------

Apply Reset

- DID Allocation** ..... Set the DID you use for External lines. (Default: Don't Select)
- Range: Don't Select or DID 1 ~ 10
  - ① When selecting a DID, the IP line number (phone number) that is entered in the SIP Server Entries is displayed.
  - ① When selecting a DID, the "Connect to" is set to the selected DID.



## DID screen

PBX Advanced Settings > DID

### ■ DID Settings

Sets the details when using the DID (Direct Inward Dialing) function.

① The above screen shows when Action (4) is set to “Call Default Destination.”

- ① **Index** ..... Select a DID that you want to edit its settings. (Default: DID 1)
- ② **Response Time** ..... Set the delay time to sound a Dial Tone (3) since an inbound call has arrived. (Default: 4)
  - Range: 0 ~ 10 (seconds)
- ③ **Dial Tone** ..... Selects the tone pattern that sounds on an IP phone. (Default: Type 1)
  - Options: Type 1 ~ 3
- ④ **Action** ..... Select the timeout action of the RoIP gateway when the particular period of time (6) has passed without receiving any DTMF signal. (Default: Clear Down)
  - **Clear Down:** Cancels the call without calling the client transceiver.
  - **Call Default Destination:** Makes a call to the Default Call Destination Number (5).
- ⑤ **Default Call Destination Number** ..... Displayed only when Action (4) is set to “Call Default Destination.” Set the Destination phone number.
- ⑥ **Timer** ..... Enter the time period for timeout timer. (Default: 10)
  - Range: 0 ~ 120 (seconds)
  - ① When setting this item to “0,” the timeout timer does not work.
  - ① The timer will be expired when a DTMF signal is detected.
- ⑦ **<Apply>** ..... Click to apply the entries.
- ⑧ **<Reset>** ..... Click to reset the settings.
  - ① You cannot reset after clicking <Apply>.

#### About the DID operation

After the set period of time in Timer (6) has passed without any operation since starting the Dial Tone, the DID starts the Action (4).

- ① You can immediately dial by pushing “#” without waiting for 5 seconds of digit interval timer.
- ① When dialing an incomplete phone number that does not include a DID number, the call will be canceled after the Busy Tone sounds.

## DID screen

PBX Advanced Settings > DID

### ■ List of DID settings

Displays the DID list.

**List of DID settings**

Index	Response Time	Dial Tone	DID Timeout		
			Action	Default Call Destination Number	Timer
DID 1	4	Type 1	Call Default Destination	3000*101	10
DID 2	4	Type 1	Clear Down	-	10
DID 3	4	Type 1	Clear Down	-	10
DID 4	4	Type 1	Clear Down	-	10
DID 5	4	Type 1	Clear Down	-	10
DID 6	4	Type 1	Clear Down	-	10
DID 7	4	Type 1	Clear Down	-	10
DID 8	4	Type 1	Clear Down	-	10
DID 9	4	Type 1	Clear Down	-	10
DID 10	4	Type 1	Clear Down	-	10

① When a DID is set, the IP line setting in Inbound Call is changed to DID. (PBX > Inbound Call)

**Inbound Call**

Phone Number	Line	Connect to	Ringtone	Queuing
100	IP Line	DID 1	Outside Tone A	OFF
VEPG4	Peer to Peer	None	Inside Tone A	OFF

---

Administrator screen .....	15-2
■ Administrator Password .....	15-2
Management Tools screen .....	15-3
■ USB .....	15-3
■ HTTP/HTTPS .....	15-5
■ If you cannot access the setting screen .....	15-6
■ Telnet/SSH .....	15-7
■ Unit ID Confirmation .....	15-8
Date and Time screen .....	15-9
■ Date and Time .....	15-9
■ Time Zone .....	15-10
■ NTP .....	15-11
■ SNTP Server .....	15-12
SYSLOG screen .....	15-13
■ SYSLOG .....	15-13
SNMP screen .....	15-14
■ SNMP .....	15-14
Network Test screen .....	15-15
■ Ping Test .....	15-15
■ Traceroute Test .....	15-16
Management LTE Module screen .....	15-17
■ Management LTE Network .....	15-17
Reboot screen .....	15-18
■ Reboot .....	15-18
Settings Backup/Restore screen .....	15-19
■ Settings Backup .....	15-19
■ Settings Restore .....	15-19
■ List of Settings .....	15-20
Factory Defaults screen .....	15-21
■ Factory Defaults .....	15-21
Firmware Update screen .....	15-22
■ Firmware Status .....	15-22
■ Online Update .....	15-23
■ Automatic Update .....	15-24
■ Manual Update .....	15-24

## Administrator screen

Management > Administrator

### Administrator Password

Set a password for accessing the setting screen.

**Administrator Password**

---

Username : ① admin

Current Password : ② \_\_\_\_\_

New Password : ③ \_\_\_\_\_

New Password (Confirm) : ④ \_\_\_\_\_

- |                                     |   |
|-------------------------------------|---|
| ① <b>Username</b> .....             | Displays the administrator login ID (“admin”).<br>① You cannot change the Username.   |
| ② <b>Current Password</b> .....     | Enter the current password, when you change it. (Default: admin)<br>① The entered characters are displayed as an * (asterisk) or a • (dot). |
| ③ <b>New Password</b> .....         | Enter a new password of up to 31 characters.<br>① The entered characters are displayed as an * (asterisk) or a • (dot).                     |
| ④ <b>New Password (Confirm)</b> ... | Enter the new password again.   |
| ⑤ <b>&lt;Apply&gt;</b> .....        | Click to apply the entries.   |
| ⑥ <b>&lt;Reset&gt;</b> .....        | Click to reset the settings.<br>① You cannot reset after clicking <Apply>.  |

**CAUTION:** If you have forgotten the password, you cannot access the RoIP Gateway’s setting screen. In this case, you have to initialize the RoIP Gateway. See the Section 5 of the Installation guide for details.

#### To prevent unauthorized access

You must be careful when choosing your password. A good policy is to occasionally change it.

- Choose one that is not easy to guess.
- Use numbers, characters, and letters (both upper and lower case).

## Management Tools screen

Management > Management Tools

### ■ USB

Settings for USB flash drives that will be connected to the USB ports.

**USB**

---

USB Flash Drive : ①  Disable  Enable

USB Access Permission : ②  Firmware Update  
 Settings Backup/Restore

USB Authentication Key: ③ \_\_\_\_\_

Write USB Authentication Key: ④

- ① USB Flash Drive .....**                      Select "Enable" to use a USB flash drive.                      (Default: Enable)

① If you use the Automatic firmware update function, or Automatic Setting Load function, select "Enable."
- ② USB Access Permission ...**                      Select the USB flash drive access option.

(Default:  Firmware Update  
 Settings Backup/Restore)

  - Firmware Update (p.15-22)
  - Settings Backup/Restore (p.15-19)
- ③ USB Authentication Key ...**                      Enter a USB Authentication Key of up to 64 characters to import to and export from the USB flash drive.

  - ① This Key can restrict access to the Firmware Update function and Settings Backup/Restore function.
  - ① After entering the characters, click <Apply> in the Management Tools.
  - ① If you set the USB Authentication Key, the RoIP Gateway can verify the USB authentication key written in the USB flash drive.

## Management Tools screen

### Management > Management Tools

#### ■ USB

**USB**

USB Flash Drive : 1  Disable  Enable

USB Access Permission : 2  Firmware Update  
 Settings Backup/Restore

USB Authentication Key: 3 \_\_\_\_\_

Write USB Authentication Key: 4

#### 4 Write USB Authentication Key

Click to write the USB Authentication Key to the USB flash drive that is inserted in the [USB] port.  
Click <Write>, then continue as shown below.

If you have inserted a flash drive in which an authentication key is already saved, “An authentication key already exists on the USB flash drive. If you want to overwrite the key, click the “Next” button.” is displayed.

**Write USB Authentication Key**

This wizard allows you to write the authentication key to a USB flash drive. Insert a USB flash drive to the system, and click the “Next” button if you are ready.



**Write USB Authentication Key**

The authentication key has been written to the USB flash drive.

When the “The USB Authentication Key has been changed. Write the key after saving it by pushing the Apply button.” window is displayed, click <OK> and then click <Apply> in the Management Tools screen.

This site says...

The USB authentication key has been changed.  
Write the key after saving it with the Apply button.

## Management Tools screen

Management > Management Tools

### ■ HTTP/HTTPS

HTTP and HTTPS are the protocols to access from a web browser.

① When you set HTTP settings and HTTPS settings to “Enable,” you can not access the setting screen using a browser.

HTTP/HTTPS	
HTTP :	① <input type="radio"/> Disable <input checked="" type="radio"/> Enable
HTTP Port :	② 80
HTTPS :	③ <input checked="" type="radio"/> Disable <input type="radio"/> Enable
HTTPS Port :	④ 443

- ① HTTP** ..... Select whether to allow access using the HTTP protocol. (Default: Enable)
- ② HTTP Port**..... Enter the HTTP Port number (Default: 80)
  - Range: 80, or 1024 ~ 65535.
  - Some of the RoIP Gateway’s ports cannot access HTTP.
  - ① Enter a different port number from HTTPS, Telnet or SSH.
- ③ HTTPS** ..... Select whether to allow access using the HTTP protocol. (Default: Disable)
  - ① HTTPS access is more secure than Telnet or HTTP access because the passwords and data are encrypted.
- ④ HTTPS Port** ..... Enter the HTTPS Port number. (Default: 443)
  - Range: 443, or 1024 ~ 65535.
  - Some the RoIP Gateway’s ports cannot access HTTPS.
  - ① Enter a port number different from HTTP, Telnet or SSH.

## Management Tools screen

### Management > Management Tools

## ■ If you cannot access the setting screen

Access Telnet or SSH (Example:192.168.0.1).

- See the INSTALLATION GUIDE Section 6 for details.
- Set to default, the RoIP Gateway can not be accessed from a Telnet client because the Telnet setting is set to "Disable."(Management > Management Tools > Telnet/SSH > Telnet) (See page 15-7.)

After entering "VE-PG4>," enter the letters written in bold as follows, and then press [Enter].

1. Enter "**network http enabled on**," and then press [Enter].
2. Enter "**save**," and then press [Enter].
  - The setting is applied.
3. Check if you can access the setting screen.

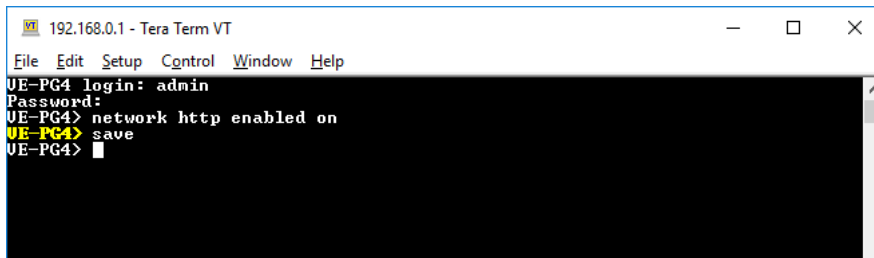

```
192.168.0.1 - Tera Term VT
File Edit Setup Control Window Help
UE-PG4 login: admin
Password:
UE-PG4> network http enabled on
UE-PG4> save
UE-PG4> █
```



## Management Tools screen

Management > Management Tools

### Telnet/SSH

Set for accessing the RoIP Gateway using Telnet or SSH.

**Telnet/SSH**

Telnet: 1  Disable  Enable

Telnet Port: 2

SSH: 3  Disable  Enable

SSH Authentication Method: 4  ▼

SSH Port: 5

SSH Public Key: 6

- 1 Telnet** ..... Select whether or not to allow access to the RoIP Gateway using Telnet. (Default: Disable)
- 2 Telnet Port** ..... Enter the Telnet Port number. (Default: 23)

  - Range: 23, or between 1024 and 65535.
  - Some the RoIP Gateway's ports cannot access Telnet.

① Enter a different port number different than HTTP, HTTPS, or SSH.
- 3 SSH** ..... Select whether to allow to access by the SSH protocol. (Default: Enable)

  - ① By using SSH, you can encrypt the contents to be set using the SSH client program.
  - ① This product supports only the SSH protocol Version 2.
  - ① Prepare an SSH client to use SSH.
- 4 SSH Authentication Method** ..... Select the SSH Authentication Method to access the RoIP Gateway when you set SSH Settings to "Enable." (Default: Automatic)

  - **Password:** Authenticating with the password.
  - **Public Key:** Authenticating with the Public Key.
  - **Automatic:** Automatically authenticating with the password or the Public Key.
- 5 SSH Port** ..... Enter the Telnet Port number. (Default: 22)

  - Range: 22, or between 1024 and 65535.
  - Some of the RoIP Gateway's ports cannot access SSH.

① Enter a port number that is different from HTTP, Telnet, or HTTPS.
- 6 SSH Public Key** ..... Set the Public Key for accessing.

① Displayed only when the SSH setting is set to "Enable" and SSH Authentication Method is set to "Public" or "Automatic."

## Management Tools screen

Management > Management Tools

### ■ Unit ID Confirmation

You can know which VE-PG4 is the current RoIP Gateway by the blinking lights on it.

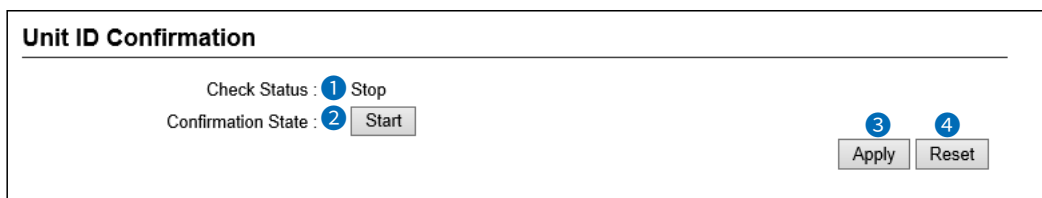

- 1 Check Status** .....

Display the status of the Unit ID.

  - **Checking:**      Checking the Unit ID and [PWR] blinks red.
  - **Stop:**            Does not check.
  
- 2 Confirmation State** .....

Click <Start> to start checking.

  - [PWR] blinks red.
  - While checking, the <Start> button changes to the <Stop> button.
  - This function automatically stops in 2 minutes, but you can also manually stop the check by clicking <Stop>.
  
- 3 <Apply>** .....

Click to apply the entries set on the Management Tool screen.
  
- 4 <Reset>** .....

Click to reset the settings, when you change the settings on the "Management Tools" screen.

① You cannot reset after clicking <Apply>.

## Date and Time screen

Management > Date and Time

### ■ Date and Time

You can set the RoIP Gateway internal clock time. (See Section 3 for details.)

**Date and Time**

---

Current Time : ①

Manually Set Time : ②  -  -  :  (Year-Month-Day Hour:Minute)  ③

- ① **Current Time** ..... Displays the current time.
- ② **Manually Set Time** ..... Displays the time when you opened this screen.  
 ⓘ Refresh the browser screen to refresh the time.
- ③ **<Set>** ..... Click to set the internal clock to the time displayed in the “Manually Set Time”(②).  
 ⓘ Before clicking <Set>, refresh the browser screen.

## Date and Time screen

Management > Date and Time

### ■ Time Zone

Select the appropriate Time Zone.

**Time Zone**

---

Time Zone : ① UTC ▼

Use Daylight Savings Time : ②  Disable  Enable

① **Time Zone** ..... Select the appropriate Time Zone. (Default: UTC)

② **Use Daylight Savings Time** Select "Disable" if not necessary. (Default: Enable)

① If "Enable" is selected, the RoIP Gateway automatically adjusts the time according to your time zone.

① If Daylight Savings Time is not used in your area, set to "Disable."

## Date and Time screen

Management > Date and Time

### ■ NTP

The Automatic Clock Synchronize function automatically synchronizes the internal clock with the time server (NTP).

① To use this function, an Internet connection and default gateway settings are necessary.

**NTP**

---

NTP Client : ①  Disable  NTP  LTE

NTP Server 1 : ② 210.173.160.27

NTP Server 2 : ③ 210.173.160.57

Status : ④ Not synchronized

- ① **NTP Client** ..... Select whether or not to use the Automatic Clock Synchronize function.  
(Default: Disable)
  - **Disable:** Not used.
  - **NTP:** Set to the internal clock automatically by accessing the NTP.
  - **LTE:** Set to the internal clock automatically by accessing the LTE Module.
  
- ② **NTP Server 1** ..... Enter the time management server's IP address.  
(Default: 210.173.160.27)  
If the RoIP Gateway cannot access this address, the address set in the [NTP Server 2] (③) item is used.
  
- ③ **NTP Server 2** ..... Enter the second time management server's IP address.  
(Default: 210.173.160.57)
  
- ④ **Status** ..... Displays the status whether or not to synchronize with the NTP Server or the transceiver module.

**CAUTION:** When you select NTP Client as NTP, you must set the Interface for the NTP server.  
(Network Settings > IP Address > IP Address > Default Gateway)  
(Network Settings > Static Routing > Static Routing)

**TIP: The Automatic Clock Synchronize function**

When you connect to the SIM card,

- Set the Automatic Clock Synchronize function to LTE, to synchronize the current time to the transceiver module.
- Set the Automatic Clock Synchronize function to NTP, to synchronize the current time to the NTP server.
- After inserting the SIM card, the RoIP Gateway is automatically set to the Automatic Clock Synchronize function.

## Date and Time screen

Management > Date and Time

### ■ SNTP Server

The SNTP server is for other RoIP devices that have no route to an external Time server (NTP).

① To use this function, an Internet connection and default gateway settings are necessary.

**SNTP Server**

SNTP Server : ①  Disable  Enable

The SNTP server is for our RoIP devices which have no route to an external NTP server.

Apply ②    Reset ③

- ① **SNTP Server** ..... Select "Enable" to use the SNTP function. (Default: Enable)  
When you select 'Enable', the RoIP devices function as an NTP server and set the internal clock time of the RoIP Gateway.  
① This function can be used only for Icom RoIP devices, which cannot set the route to the external NTP server.  
① Set the Date and Time screen before using this function.
- ② **<Apply>** ..... Click to apply the entries set on Time Zone, NTP, and SNTP Server.
- ③ **<Reset>** ..... Click to reset the settings when you change the settings on Time Zone, NTP, and SNTP Server.  
① You cannot reset after clicking <Apply>.

## SYSLOG screen

Management > SYSLOG

### ■ SYSLOG

Select the information to be saved to the SYSLOG host.

**1** **DEBUG** ..... Select “Enable” to display the debug information in Host IP Address (**4**).  
(Default: Disable)

**2** **INFO** ..... Select “Enable” to display the INFO messages in Host IP Address (**4**).  
(Default: Enable)

**3** **NOTICE** ..... Select “Enable” to display the NOTICE messages in Host IP Address (**4**).  
(Default: Enable)

**4** **Host IP Address** ..... Enter the SYSLOG host’s address.  
① The host device must have the SYSLOG server function.

**5** **<Apply>** ..... Click to apply the entries.

**6** **<Reset>** ..... Click to reset the settings.  
① You cannot reset after clicking <Apply>.

## SNMP screen

Management > SNMP

### ■ SNMP

Configure the SNMP function, that is information on the RoIP Gateway for being collected by each host in the IP network for their network management.

- 1** **SNMP**..... Select “Enable” to manage the setting information in the SNMP management tool. (Default: Enable)
- 2** **Community Name (GET) ...** Enter the Community name to get the SNMP community string. (Up to 31 characters) (Default: public)
- 3** **System Location** ..... Enter the SNMP system location. (Up to 127 characters)
- 4** **System Contact** ..... Enter the SNMP system contact. (Up to 127 characters)
- 5** **<Apply>** ..... Click to apply the entries.
- 6** **<Reset>** ..... Click to reset the settings.  
 ⓘ You cannot reset after clicking <Apply>.



## Network Test screen

Management > Network Test

### ■ Ping Test

Verifies that a particular IP address exists and can accept requests.

**Ping Test**

Host : 1 \_\_\_\_\_

Number of times : 2 4

Packet Size : 3 64 bytes

Timeout : 4 1000 milliseconds

Ping 5

- 1 **Host** ..... Enter the IP address or Domain Name of up to 64 characters to send the Ping packets to.
- 2 **Number of Times** ..... Select the number of times to send. (Default: 4)  
• Options: 1, 2, 4, 8
- 3 **Packet Size** ..... Select the size of the packet's data. (Default: 64)  
• Options: 32, 64, 128, 256, 512, 1024, 1448, 1500, 2048 (bytes)
- 4 **Timeout**..... Select the Ping response time. (Default: 1000)  
Note: If there is no response within the selected time, a time out error is returned.  
• Options: 500, 1000, 5000 (milliseconds)
- 5 **<Ping>** ..... Click to run the Ping test.  
① The test result is displayed as shown below.

**Ping Result**

```

PING 192.168.100.1 (192.168.100.1) 56(84) bytes of data.
64 bytes from 192.168.100.1: icmp_req=1 ttl=59 time=9.82 ms
64 bytes from 192.168.100.1: icmp_req=2 ttl=59 time=7.00 ms
64 bytes from 192.168.100.1: icmp_req=3 ttl=59 time=5.90 ms
64 bytes from 192.168.100.1: icmp_req=4 ttl=59 time=6.62 ms

--- 192.168.100.1 ping statistics ---
4 packets transmitted, 4 received, 0% packet loss, time 3010ms
rtt min/avg/max/mdev = 5.909/7.342/9.824/1.486 ms
    
```

Save Back

- ① Click <Save> to save the result to a PC as a text file (extension: "txt").  
Note: The file is saved as "ping\_host's address.txt."
- ① Click <Back> to return to the Ping Test screen.

## Network Test screen

Management > Network Test

### ■ Traceroute Test

Executes a tracerout test against a particular node.

- 1 **Node** ..... Enter the node's (device's) IP address or Domain Name of up to 64 characters.
- 2 **Maximum Hop Count** ..... Select the maximum hop number. (Default: 16)  
• Options: 4, 8, 16, 32
- 3 **Timeout**..... Select the response time. (Default: 3)  
Note: If there is no response within the selected time, a time out error is returned.  
• Options: 1, 3, 5 (seconds)
- 4 **DNS Lookup** ..... Select "Enable" to convert the node's (device's) IP address into the host name. (DNS name resolution) (Default: Enable)
- 5 **<Traceroute>** ..... Click to run the traceroute test.

• The test result is displayed as shown below.

```

Traceroute Result

traceroute to 192.168.100.1 (192.168.100.1), 16 hops max, 38 byte packets
 1 192.168.100.1 1.885 ms 2.101 ms 2.248 ms
 2 192.168.100.2 20.590 ms 32.736 ms 5.745 ms
 3 192.168.54.1 17.774 ms 4.630 ms 4.497 ms
 4 192.168.53.4 5.841 ms 4.537 ms 7.152 ms
 5 192.168.100.3 10.446 ms 8.165 ms 8.240 ms
 6 192.168.100.1 10.473 ms 8.243 ms 8.037 ms
    
```

- Click to save the result to a PC as a text file (extension: "txt").
- The file is saved as "tracert\_*node's address*.txt."
- Click <Back> to return to the Traceroute Test screen.

## Management LTE Module screen

Management > Management LTE Module

### ■ Management LTE Network

The settings and status for connecting to a LTE network.

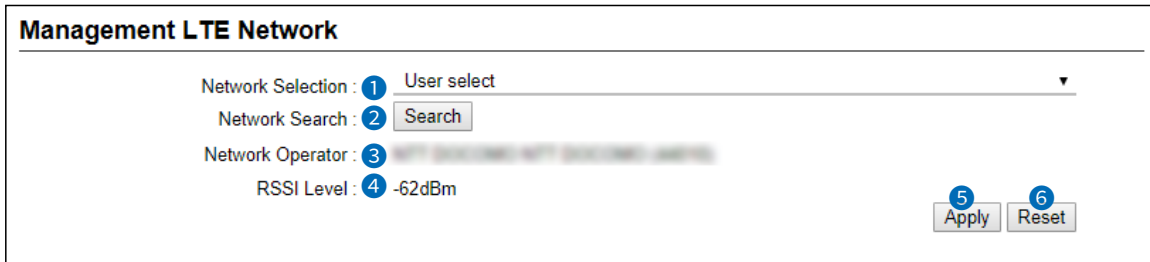

- 1 Network Selection** .....

Set to automatically select the LTE Network, select the last accessed, or enable the User to select. (Default: Auto)

  - **Auto:** Automatically selects the network that the LTE module can connect to. LTE is selected prior to 3G if both of them are usable.
  - **Last accessed:** When turning on the RoIP Gateway, the same connection way as before is attempted. If the previous LTE Network Operator (PLMN) is not saved, 'Auto' is selected, and saves the LTE Network Operator (PLMN) when the network is able to connect.
    - ① The RoIP Gateway works as the same way as the "Auto" setting, if it could not connect to the last accessed LTE Network Operator (PLMN.)
  - **User select:** You can select the network from LTE or 3G after searching. If the selected network cannot be found, the RoIP Gateway cannot connect to the network.
  
- 2 Network Search** .....

If you select "User select," the Network Search setting is displayed. Click <Search>, and <OK> on the displayed dialog, to display the list of the LTE Network Operators (PLMN) that this RoIP Gateway can connect to.

  - ① Loading may take a few minutes or more.
  
- 3 Network Operator** .....

Displays the connected LTE Network Operator (PLMN).
  
- 4 RSSI Level** .....

Displays the RSSI (Received Signal Strength Indicator) level (dBm).
  
- 5 <Apply>** .....

Click to apply the entries.
  
- 6 <Reset>** .....

Click to reset the settings.

  - ① You cannot reset after clicking <Apply>.

## Reboot screen

Management > Reboot

### ■ Reboot

Click <Reboot> to reboot the RoIP Gateway.

<b>Reboot</b>
Reboot Now : <input type="button" value="Reboot"/>

## Settings Backup/Restore screen

Management > Settings Backup/Restore

### ■ Settings Backup

Save the RoIP Gateway's settings to a PC as a backup.

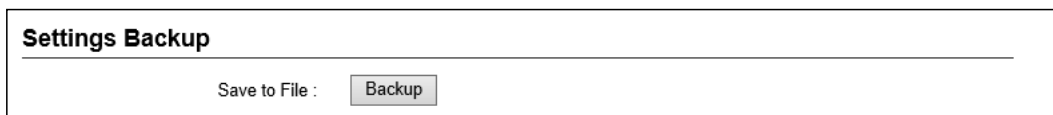

Settings Backup

Save to File :

**Save to File** ..... Click <Backup> to save the settings to a PC as a backup file (Extension: sav).  
See the topic below to load the saved file into the RoIP Gateway.

Management > Settings Backup/Restore

### ■ Settings Restore

Load the setting file (Extension: "sav") into the RoIP Gateway.

Note: Loading takes a few minutes.

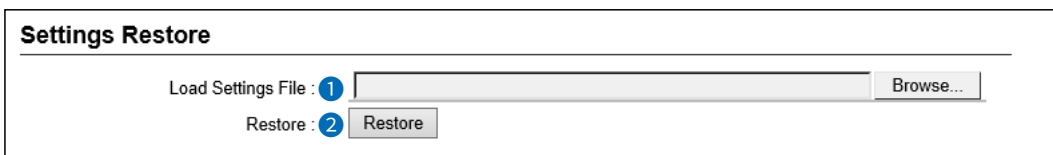

Settings Restore

Load Settings File : ①  

Restore : ②

**① Load Settings File** ..... Click <Browse> to select the setting file.

**② Restore** ..... Click <Restore> to load the setting into the RoIP Gateway.

Notes:

- The RoIP Gateway's settings are overwritten.
- After loading, the RoIP Gateway automatically reboots.

Caution: Do not modify the settings other than the VE-PG4.

## Settings Backup/Restore screen

Management > Settings Backup/Restore screen

### ■ List of Settings

Displays the changed settings.

Note: The list is cleared when the RoIP Gateway is initialized.

```
List of Settings
ext port in_timing 2 sw
ext port in_timing 3 break
ext port out_voice_ctrl 2 rtp
ext port out_voice_ctrl 3 off
ext port out_voice_delay 2 5
ext port out_voice_delay 3 300
ext port out_waittime 2 500
ext port out_waittime 3 0
ext port ptt_gd_time 2 0
ext port ptt_gd_time 3 400
ext port pullup_ctrl 2 on
ext port pullup_ctrl 3 off
ext port radio_connect 2 none
ext port radio_connect 3 inout
ext port radio_model 2 almighty
ext port radio_model 3 ic4810
ext port radio_receive_mode 2 vox
ext port radio_receive_mode 3 sql
ext port recv_priority 2 off
ext port recv_priority 3 on
ext port rxgain_offset 2 0
ext port rxgain_offset 3 -2
ext port txgain_offset 2 0
ext port txgain_offset 3 -6
ipradio call_tbl call_id 1 1001
ipradio call_tbl call_id 2 1001
```

(This is only an example.)

## Factory Defaults screen

Management > Factory Defaults

### ■ Factory Defaults

You can reload the RoIP Gateway settings to the factory defaults.

① If you forget the IP address and the Administrator's password, see Section 5 in the Installation guide.

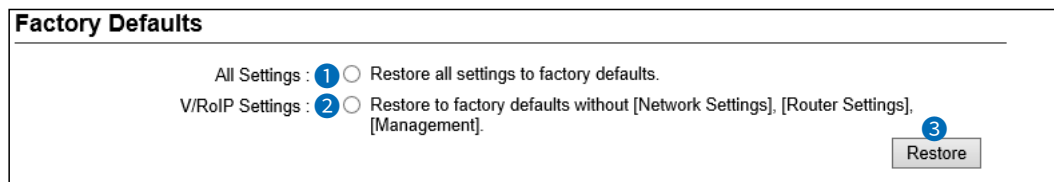

**① All Settings** .....

Select to return all settings to the factory defaults.

① After the RoIP Gateway is initialized, the IP address is returned to the default (192.168.0.1).

① If the network part of the PC IP address is different from that of the RoIP Gateway, you cannot access the RoIP Gateway setting screen. In such case, change the PC IP address according to your network environment.

**② V/RoIP Settings** .....

Select to return the settings to the factory defaults except for the Network Settings, the Router Settings, and the Management Settings.

**③ Restore** .....

Click to restore the settings.

## Firmware Update screen

Management > Firmware Update

**NOTE:**

- NEVER turn OFF the power until the update has been completed. Otherwise, the RoIP Gateway may be damaged.
  - While updating, all connections are disconnected
- ① Ask your dealer for updated function or specification details.

### ■ Firmware Status

Displays the firmware version.

Firmware Status
Version : VE-PG4 Ver. Copyright Icom Inc.



## Firmware Update screen

Management > Firmware Update

### ■ Online Update

Downloads the firmware through the Internet, and automatically updates it.

**NOTE:** To use this function, an Internet connection, or LTE(4G/3G) is required.

**Online Update**

---

Check for Updates :

**Check for Updates** .....

Click <Check> to access the update management server. When the RoIP Gateway has successfully accessed the server, the latest firmware version is displayed, as shown below.

**Online Firmware Update**

---

**Firmware Information**

Status	Succeeded in gathering information.
Version	1.0.0
Changes	None

**About the firmware information:**

- When there is a new firmware update available, the <Update Firmware> button is displayed.
- When there is no firmware update, “Firmware already up-to-date” is displayed.
- When an error message is displayed, check the network connection so that you can access the update management server, as follows:

**When a SIM card is installed:**

- Confirm that the antennas are attached properly to the [ANT1] and [ANT2] connectors.

**When a SIM card is not installed:**

- Confirm that the default gateway and DNS server address are properly set to the RoIP Gateway. (Network Settings > IP Address)
- Ask your network administrator if a web transmission from the RoIP Gateway is blocked.

**CAUTION:** Do not turn OFF the power until the firmware update is completed.

① Ask your dealer for updated function or specification details.

## Firmware Update screen

Management > Firmware Update

### ■ Automatic Update

The firmware can be automatically downloaded and updated.

① When a SIM card is inserted, the Automatic Update Setting is not displayed.

- ① **Automatic Update** ..... Select "Enable" to use the Automatic Update function. (Default: Enable)  
 ① Select "Disable" if you do not want to automatically update the firmware.
- ② **<Apply>** ..... Click to apply the entries.
- ③ **<Reset>** ..... Click to reset the settings.  
 ① You cannot reset after clicking <Apply>.

### ■ Manual Update

The firmware can be updated using the saved firmware.

- ① **Select the update file** ..... Click <Browse...> to select the firmware file (extension: "dat").  
 ① The selected file appears in the "Update Firmware using File" item.
- ② **Firmware Update** ..... Click <Update> to update the firmware.  
 Note: After updating, the RoIP Gateway automatically reboots.

**CAUTION:** Do not turn OFF the power until the firmware update is completed.  
 ① Ask your dealer for updated function or specification details.

**Count on us!**

